

Natural England Commissioned Report NECR086

# A review of techniques for monitoring the success of peatland restoration

First published 02 September 2011

[www.naturalengland.org.uk](http://www.naturalengland.org.uk)





# Foreword

Natural England commission a range of reports from external contractors to provide evidence and advice to assist us in delivering our duties. The views in this report are those of the authors and do not necessarily represent those of Natural England.

## Background

An important element of all peatland restoration projects is a programme of monitoring to check results and progress. Several peat project workshops identified a demand for technical guidance on monitoring techniques. So Natural England commissioned this study to:

- Review the range of peatland restoration monitoring techniques available.
- Identify those that were consistent, informative and easily applicable for peatland restoration projects at a range of scales and budgets.

Tables to identify appropriate monitoring techniques for specific projects are published in the Technical Information Note TIN097 - *Guidelines for monitoring peatland restoration*. Further information on these techniques is provided in this report.

The findings of this study have been used to:

- Inform the JNCC project to design a research programme on UK Peatland Green House Gas and Carbon Flux.
- Develop thinking on monitoring peatlands in the IUCN UK Peatland Programme.

- Inform hydrological monitoring programmes for the Dartmoor and Exmoor Mires Project.

These findings are being disseminated to:

- Encourage the use of balanced and consistent approaches to peatland restoration monitoring.
- Develop consistency in monitoring approaches so as to enable possible future collation of peatland monitoring data as a single database resource.

A single database resource of peatland restoration would enable more robust analyses of monitoring data to support the development and implementation of future support and management techniques for peatland restoration.

This report should be cited as:

BONNETT, S.A.F., ROSS, S., LINSTEAD, C. & MALTBY, E. 2009. *A review of techniques for monitoring the success of peatland restoration*. University of Liverpool. Natural England Commissioned Reports, Number 086.

**Natural England Project Manager** - Matthew Shepherd, Renslade House, Bonhay Road, Exeter, EX4 3AW  
[matthew.j.shepherd@naturalengland.org.uk](mailto:matthew.j.shepherd@naturalengland.org.uk)

**Contractor** - Institute for Sustainable Water, Integrated Management and Ecosystem Research, University of Liverpool, Nicholson Building, Brownlow Street, Liverpool, L69 3GP

**Keywords** - peat, peatlands, bog, blanket bog, fen, mire, raised bog, monitoring, surveillance, carbon budget, greenhouse gases, carbon dioxide, hydrology; restoration, rewetting, bird survey, microorganisms, invertebrates survey, grip blocking, water quality, carbon, erosion, habitat monitoring

### Further information

This report can be downloaded from the Natural England website: [www.naturalengland.org.uk](http://www.naturalengland.org.uk). For information on Natural England publications contact the Natural England Enquiry Service on 0845 600 3078 or e-mail [enquiries@naturalengland.org.uk](mailto:enquiries@naturalengland.org.uk).

You may reproduce as many individual copies of this report as you like, provided this is not for commercial purposes, and such copies stipulate that copyright remains with Natural England, 1 East Parade, Sheffield, S1 2ET

ISSN 2040-5545

© Natural England and other parties 2011



**Acknowledgements**

We would like to acknowledge Jonathan Walker, Aletta Bonn and Sharon Davison at Moors for the Future for their input and guidance on the web survey and technical report; Penny Anderson & Katherine Longden from Penny Anderson & Associates for support at the Natural England workshop on peatland restoration; and also, Matthew Shepherd at Natural England for his comments and suggestions for the Technical Report.

## 1. PREFACE

### 1.1. Some challenges to monitoring of peatland restoration and management

'Peatland' is a term used to describe the physiographic, geomorphological, ecological and biogeographical setting of peat and may include areas which no longer support peat-forming plant communities (Moore & Bellamy, 1974; Clymo, 1983; Maltby, 1997). Ecosystems which are actively peat-forming are called mires (Moore, 1975; Gore, 1983).

The environment in which peat formation and subsequent development has taken place has experienced both natural fluctuations and human-induced impacts. It is unclear whether current environmental change (e.g. climate, land use, nitrogen deposition) can continue to support peat-formation or even peat stabilization. Change is a feature of the natural environment and a significant part of the peat resource in the UK, especially in the uplands, is undoubtedly the outcome of previous as well as more recent human intervention in the landscape.

Fundamental challenges to monitoring arise because (a) we do not necessarily know with certainty the conditions necessary for the development and maintenance of a particular desired state of a peatland, and (b) environmental change may restrict the restoration options, meaning that monitoring may be focused on unattainable objectives.

Any monitoring strategy needs to be mindful that

- (1) Different ecosystems can exist in more or less stable forms on the same land surface.
- (2) There is considerable variation in the genesis, pattern and stage of development and functioning of peat systems.
- (3) Final goals may be attained only after a long (and possibly unplannable) period of intervention.

Mires are arguably amongst the most sensitive ecosystems on the planet due to their limited capacity for self-repair (Maltby, 1997). Human intervention may redirect the course of ecosystem development along different pathways with divergent end-points. If effective monitoring strategies are developed to determine restoration success, it is important that the techniques also inform us about critical tolerance levels or thresholds for physical pressures, hydrological change, temperature, pH and pollution, among others, and the effect these have on ecosystem functioning rather than just structure and appearance. Monitoring can inform us *if* restoration is successful, but it should also help us evaluate *why* it has been successful. This is a high priority for the science agenda. It is underlined in the current policy shift towards better recognition of the importance of natural systems such as peatland in the maintenance and enhancement of ecosystem services essential to human well being.

## CONTENTS

<b>1. PREFACE .....</b>	<b>ii</b>
<b>1.1. Some challenges to monitoring of peatland restoration and management .....</b>	<b>ii</b>
<b>EXECUTIVE SUMMARY .....</b>	<b>1</b>
<b>2. INTRODUCTION.....</b>	<b>6</b>
<b>2.1. Aims of technical report and guidance document .....</b>	<b>7</b>
<b>2.2. Peatland restoration objectives.....</b>	<b>8</b>
<b>2.3. Why monitor peatland restoration success? .....</b>	<b>9</b>
2.3.1. Alternative stable states and thresholds.....	10
<b>2.4. Evaluating restoration success.....</b>	<b>11</b>
2.4.1. Reference states .....	11
2.4.2. Species as indicators of success .....	13
<b>3. FRAMEWORK FOR DESIGNING A MONITORING PROTOCOL .....</b>	<b>14</b>
<b>3.1. Defining objectives of restoration and monitoring .....</b>	<b>16</b>
3.1.1. Identify restoration objectives .....	16
3.1.2. Identify monitoring objectives .....	17
<b>3.2. Pre-restoration monitoring .....</b>	<b>20</b>
<b>3.3. Establish monitoring criteria.....</b>	<b>20</b>
<b>3.4. Design the monitoring protocols .....</b>	<b>21</b>
3.4.1. Site characteristics.....	22
3.4.2. Scale of assessment .....	24
3.4.3. Starting point .....	25
3.4.4. Intensity and duration .....	25
3.4.5. Costs and expertise.....	26
3.4.6. Documentation .....	27
<b>3.5. Assessment of restoration success .....</b>	<b>27</b>
3.5.1. Direct comparison .....	28
3.5.2. Trajectory analysis .....	28
<b>3.6. Adaptive management decisions .....</b>	<b>29</b>
<b>4. MONITORING TECHNIQUES.....</b>	<b>30</b>
<b>4.1. Choosing monitoring techniques .....</b>	<b>30</b>
<b>4.2. Peat physical integrity .....</b>	<b>32</b>
4.2.1. Introduction.....	32
4.2.2. Measuring change in peat surfaces and peat depth .....	32

4.2.3. Physical characteristics of peat .....	36
4.2.3.1. Bulk density .....	36
4.2.3.2. Humification .....	37
4.2.4. Palaeoenvironmental techniques.....	39
4.2.5. Conclusions.....	40
<b>4.3. Biota .....</b>	<b>41</b>
4.3.1. Vegetation .....	41
4.3.1.1. Introduction.....	41
4.3.1.2. Sampling regimes .....	44
4.3.1.2.1. <i>Permanent sample plots</i> .....	44
4.3.1.2.2 <i>Random sampling</i> .....	46
4.3.1.2.3 <i>Stratified random sampling</i> .....	46
4.3.1.2.4 <i>Size and number of sampling units</i> .....	47
4.3.1.3. Plant species.....	48
4.3.1.3.1. <i>Total counts</i> .....	48
4.3.1.3.2. <i>Frame quadrats</i> .....	49
4.3.1.3.3. <i>Visual estimates of cover</i> .....	49
4.3.1.3.4. <i>Frequency</i> .....	50
4.3.1.3.5. <i>Biomass</i> .....	51
4.3.1.3.7. <i>Point quadrats</i> .....	51
4.3.1.3.8. <i>Transects</i> .....	52
4.3.1.3.9. <i>Nested quadrats</i> .....	53
4.3.1.3.10. <i>Monitoring of plant populations</i> .....	54
4.3.1.4. Plant communities .....	55
4.3.1.4.1. <i>Phase 1 habitat survey</i> .....	55
4.3.1.4.2. <i>National Vegetation Classification (NVC) System</i> .....	55
4.3.1.4.3. <i>Higher Level Stewardship (HLS) vegetation type</i> .....	55
4.3.1.4.4. <i>CORINE Biotope Classification Scheme</i> .....	56
4.3.1.4.5. <i>Fixed point photography</i> .....	56
4.3.1.4.6. <i>Remote sensing</i> .....	58
4.3.1.5. Vegetation structure .....	59
4.3.1.5.1. <i>Canopy and sward heights</i> .....	59
4.3.1.5.2. <i>LIDAR</i> .....	59
4.3.1.6. Conclusions.....	60
4.3.2.1. Introduction.....	62
4.3.2.2. Common Bird Census .....	63
4.3.2.3. Breeding Bird Survey .....	63
4.3.2.4. Counting leks .....	63
4.3.2.5. Mist-netting.....	64
4.3.2.6. Point counts .....	64
4.3.2.7. Transects counts .....	65
4.3.2.8. Conclusions.....	65
4.3.3. Invertebrates .....	66
4.3.3.1. Introduction.....	66



4.3.3.2. Trapping techniques.....	70
4.3.3.2.1. Pitfall traps.....	70
4.3.3.2.2. Water traps.....	71
4.3.3.2.3. Light traps.....	72
4.3.3.2.4. Flying interception traps.....	73
4.3.3.2.5. Aerial attractant traps.....	74
4.3.3.2.6. Emergence trapping.....	74
4.3.3.2.7. Suction sampling.....	75
4.3.3.3. Direct counting.....	75
4.3.3.3.1. Sweep netting.....	76
4.3.3.3.2. Beating.....	76
4.3.3.3.4. Plankton netting.....	76
4.3.3.3.5. Extraction from peat samples.....	77
4.3.3.4. Conclusions.....	79
4.3.4. Microorganisms.....	80
4.3.4.1. Introduction.....	80
4.3.4.2. Sampling.....	81
4.3.4.3. Microscopy.....	81
4.3.4.4. Testate amoeba.....	82
4.3.4.5. Chloroform fumigation.....	82
4.3.4.6. Substrate-induced respiration.....	82
4.3.4.7. Community-level physiological profile (CLLP).....	83
4.3.4.8. Phospholipid fatty acid analysis.....	83
4.3.4.9. Extracellular enzyme activities.....	84
4.3.4.10. Nucleic acid analysis.....	84
4.3.4.11. Conclusions.....	85
<b>4.4. Hydrology.....</b>	<b>86</b>
4.4.1. Introduction.....	86
4.4.2. Dip wells.....	86
4.4.3. Piezometers.....	88
4.4.4. Channel flow.....	89
4.4.5. Precipitation.....	91
4.4.6. Evapotranspiration.....	91
4.4.7. Geochemical methods.....	93
4.4.8. Conclusions.....	93
<b>4.5. Biogeochemistry.....</b>	<b>94</b>
4.5.1. Peat and water chemistry.....	94
4.5.1.1. Introduction.....	94
4.5.1.2. pH.....	95
4.5.1.3. Redox potential.....	96
4.5.1.4. Exchangeable ions.....	97
4.5.1.5. Conclusions.....	98

4.5.2. Carbon budget .....	99
4.5.2.1. Introduction.....	99
4.5.2.2. Net primary production .....	101
4.5.2.3. Organic matter .....	102
4.5.2.4. Fluvial carbon stock.....	103
4.5.2.4.1. POC.....	103
4.5.2.4.2. DOC.....	103
4.5.3. Greenhouse gas fluxes.....	105
4.5.3.1. Introduction.....	105
4.5.3.1.1. <i>Comparison of techniques</i> .....	106
4.5.3.2. Enclosure techniques .....	107
4.5.3.2.1. <i>Enclosure construction and design</i> .....	109
4.5.3.2.2. <i>Sampling strategy</i> .....	110
4.5.3.2.3. <i>Gas analysis</i> .....	111
4.5.3.3. Micrometeorological techniques .....	112
4.5.3.4. Proxies for peatland greenhouse gas fluxes .....	114
4.5.3.5. Conclusions.....	115
<b>REFERENCES .....</b>	<b>116</b>
<b>APPENDIX 1: ONLINE SURVEY SUMMARY .....</b>	<b>144</b>
<b>APPENDIX 2: NATURAL ENGLAND WORKSHOP .....</b>	<b>165</b>
<b>A2.1. Uplands .....</b>	<b>165</b>
<b>A2.2. Lowlands .....</b>	<b>167</b>
<b>APPENDIX 3: DATABASE STRUCTURE.....</b>	<b>169</b>
<b>A3. Introduction .....</b>	<b>169</b>
<b>A3.1. Explanation of fields .....</b>	<b>170</b>
A3.1.1. Hydrology .....	170
A3.1.2. Biodiversity.....	172
A3.1.3. Carbon .....	174
A3.1.4. Water chemistry.....	175
<b>A4. Recommendations.....</b>	<b>176</b>
<b>APPENDIX 4: GREENHOUSE GAS FLUX COLLAR TECHNIQUES.....</b>	<b>177</b>
<b>A4.1 Materials and procedures .....</b>	<b>177</b>
<b>A4.2 Calculations .....</b>	<b>178</b>

## EXECUTIVE SUMMARY

- Peatlands account for approximately one-third of the world's soil carbon and contribute to the carbon (C) storage capacity of the UK. In many areas, peatland has been affected by grazing, burning and drainage. These forms of management have led to severe degradation, erosion, flooding, poor water quality and loss of ecological biodiversity. There is therefore a great deal of interest in restoring peatland ecosystems to a less degraded state. However, restoration has been based more on management and public values rather than scientific foundations. Monitoring of restoration is required to provide information that can be used to assess progress and guide adaptation of methods and goals to ensure long-term success.
- This document aims to review common techniques for monitoring the success of restoration of both upland and lowland peatlands that can be built on in the future. This report provides the detailed evidence base for the guidelines presented in the accompanying report.
- Restoration can either aim to restore the natural composition, structure and processes, and dynamics of the original ecosystem, or restore ecosystems to a sufficiently productive state to provide ecosystem goods and services to humans. The ultimate goal of restoration is to restore the ecological quality and functioning (self-sustaining ability) of the habitats within landscapes with full integration of nature conservation and other legitimate land use objectives as well as meeting wider social and economic objectives. Restoration trajectories, however, rarely approximate to natural trajectories that existed prior to degradation. Ecosystems may not always undergo ordered and predictable, gradual development but rather undergo rapid transitions between different stable states. Restoration can be viewed as an attempt to force transitions towards a desired state, and therefore requires an understanding of the variables that need to be manipulated to achieve these transitions.
- Monitoring is a necessary step in the restoration process to assess how successful restoration and management activities have been in achieving objectives, goals or targets, both on individual sites and across site series as a whole. This permits adaptive management to address specific issues or objectives that have not been met within a specific time frame to achieve those future goals at a later stage. Monitoring techniques used must be closely related to the restoration goals and objectives. A monitoring protocol may consist of a framework that goes beyond specifying only the monitoring techniques and targets, and includes objectives, goals, criteria, protocols, cost/benefit analysis, monitoring and evaluation of success.
- Setting of specific reference conditions as goals maybe unrealistic if the reference system itself were the product of specific past environmental and management events. The evaluation of long-term permanent plots provides not only more insight on their specific dynamics, but unexpected peculiarities may also lead to questioning of ecological theories or formulation of new ecological concepts.
- For each ecosystem attribute, there needs to be a clear set of defined objectives and goals for particular time periods. Some suggested measures include similarity indices between the restored system and some reference system, the use of indicator species such as *Sphagnum*, and some estimate of system response in relation to resilience measures. Indicator species or functional indicators can be used to assess the condition of a peatland. Suitable indicators would typically include species characteristic of a range of different micro-habitats, and, if possible, conspicuous species that could be recorded by a non-specialist.

- The monitoring objective is a target level of a particular monitoring parameter that indicates that the objective of restoration has been met. There are three phases of monitoring. The initial phase monitors the site prior to restoration, providing a baseline or control to assess restoration success (pre-restoration monitoring); the second phase monitors the success over a period after restoration (post-restoration) on the environmental conditions of the site; and the third is required to establish the effectiveness of longer-term site management and/or sustainability of restoration in terms of the biogeochemical functioning of the site.
- In order to evaluate the functional status of restored ecosystems, it is imperative to establish reliable criteria that will help to assess the success or failure of a given restoration project, and to set realistic and appropriate goals beforehand. These criteria are based on an understanding of the reference peatland condition that is the goal of restoration and draws on the existing understanding of how a peatland system is likely to respond in a broad way to the main restoration techniques applied. Targets should focus on short term achievements along with longer term goals.
- Two strategies exist for conducting an evaluation of restoration success: *direct comparison and trajectory analysis*. In direct comparison, selected parameters are measured in the reference and restoration sites. A restored peatland at a project site should be compared to an average of a number of reference sites within the same climatic zone rather than a single reference site. Trajectory analysis examines trends in the data sets that lead towards the reference condition and confirm that the restoration is following its intended trajectory.
- Once monitoring has been completed and an assessment made of the condition of the attributes, a feedback loop to site management or restoration is necessary in order to review the original objectives of restoration and monitoring. An unexpected response does not represent a failure for the restoration plan if it can be used to improve our understanding of a complex system so that corrective actions can be made. Adjustments in the models and measures based on information coming from the monitoring and assessment, and from supporting research and simulation modeling, is the best route to increased levels of certainty as future iterations of the restoration plan are implemented.
- Although objectives of peatland restoration are defined mainly in terms of hydrology, water chemistry and vegetation in the short term, much monitoring has focused on vegetation. Nonetheless, collecting data on hydrology, greenhouse gas fluxes, and peat and water chemistry can be very useful for the interpretation of vegetation data as well as informing about important processes and functions necessary for peatland restoration. Environmental parameters can show a response to restoration measures more rapidly than might be detected in a plant community, so an indication that the correct conditions to support the target habitat are being met may be achieved sooner by monitoring selected environmental parameters alongside vegetation. Recovery of the population of a target species may be the key objective of restoration management or it may provide valuable indication of complex environmental conditions, ecosystem functioning and/or habitat status.
- For peat integrity, quick and inexpensive assessment by erosion pins and the measurement of peat depth are recommended. However, where more detail and precision are required, POC flux and LIDAR may be more appropriate. LIDAR in particular appears promising for large-scale monitoring and mapping of surface pattern as an indicator of hydrological and ecological status in lowland raised bogs and therefore potentially in upland peatland ecosystems. Aerial photography is widely available and can also be a useful monitoring tool for large and inaccessible areas such as blanket bog. Bulk density can be determined

accurately if compression of the peat mass is avoided by collecting large peat monoliths or using a Wardenaar corer with a serrated cutting edge and large cutting diameter. Humification can be measured simply and rapidly in the field using the von Post squeeze test, although this method may suffer from personal bias, water content and is not useful for statistical analysis. Therefore, it may be most appropriate for longer-term monitoring. Other techniques such as percent transmission and luminescence can be used as a proxy for peat humification which are more detailed and precise but require costly laboratory equipment and time.

- The choice of vegetation monitoring method depends on the available resources and the scale of the site. Small permanent plots are recommended with significant replication for assessing vegetation change over time. Within large permanent plots, random sampling can be used to overcome biases. However, a large number of replicates may be required in raised bog surfaces that have a high level of small scale variability. Therefore, stratified random sampling can be used when there are obvious differences in habitat, to compare a reference and restored site, or where environmental characteristics are expected. However, this technique is limited in the statistical techniques that can be applied. The point quadrat method is time consuming but gives precise data for a limited number of species, while frame quadrats are quick but allow for recording only large changes in cover. Braun blanquet and Domin are not amenable to statistical analysis. Frequency is very quick although biased against clumped species (i.e. *Sphagnum*). Transects are used when there is an environmental gradient. The nested quadrat may be the most appropriate technique where there is a wide range of vegetation types. The size of quadrat will depend on the vegetation types i.e. shrubs, bryophytes. Phase 1 habitat survey categories are too broad to be of use for peatland restoration monitoring. The NVC methodology may be more suitable for sampling and describing vegetation. Also, Higher Level Stewardship vegetation type covers restoration of habitat types with a set of criteria, although they are unlikely to be suitable for analysis of restoration success.
- Fixed point photography is recommended for rapid, repeatable and inexpensive recordings of plant communities, species composition and habitat distribution. Whilst they do not provide primary data for statistical analysis, there are techniques available for assessing vegetation changes over time. Remote sensing techniques using low altitude, high resolution, colour and colour infrared photographs provided an accurate and efficient means of sampling vegetation cover, but individual species may not be identified, precluding estimates of species density and distribution. Aerial photography is suggested to be an effective tool for vegetation monitoring of simple habitat types dominated by a single species or when species identities are not important and vegetation structure is the main parameter to be recorded. However, the inability of aerial photography to identify individual species suggests it is limited in its usefulness for monitoring restoration success. LIDAR may be used to map past drainage of bog or the presence of colourful *Sphagnum* species in active raised bog. A combination of aerial photography and ground-based methods may be the most effective means of monitoring the success of large wetland restoration projects.
- Birds are often used as biological indicators of environmental quality as bird populations can change rapidly as a consequence of conservation management. The CBC and BBS methods are recommended as they are established techniques with available literature and data for detailed analysis and evaluation. Counting leks may be suitable for specific sites such as blanket bogs with grouse management. Mist netting is more expensive, time consuming, requires expertise and a license. However, more detailed information on productivity and survival can be obtained. Point counts are efficient and particularly good in scrub habitats,

and open bog, although they are not good for less detectable species. Tramsect counts are useful in large open areas and linear habitats such as bogs.

- The choice of invertebrate techniques to use will depend on the peatland type: upland or lowland, due to differences in habitat, and therefore depends on knowledge of autecology. The choice to monitor invertebrates will depend on the status of the restoration site (i.e. SSSI) and also on whether invertebrate indicators are deemed important for indicating restoration success. Spiders may be a particularly good indicators of total invertebrate mesofauna and therefore useful for determining habitat changes in peatland restoration. Enchytraeids and nematodes may be useful indicators for functionally important changes in the C cycle. Grouping of species by habitat preference may be a useful technique for assessing habitat disturbance and hence peatland restoration. A sampling period over at least one or two years is needed to accommodate the different phenologies, and a variety of collecting methods are needed to sample the various faunistic elements. Pitfall traps are the main techniques used in the study of the terrestrial arthropod fauna in peatlands, and special techniques are required for sampling the aquatic habitats encountered in bogs. Even if such detailed sampling is possible, sorting of such sampling is time consuming, expensive and requires specialized knowledge. Further, cooperation of numerous taxonomic experts is essential for accurate species identification in most groups.
- Microbiological techniques may be particularly useful for evaluating restoration success in peatlands. However, these techniques are time consuming and expensive to perform routinely due to equipment and staff training. However, this may only be possible via collaboration with academic research groups. Techniques such as extracellular enzymes may be of more ecological relevance than bacterial counts/microbial biomass alone, although trajectory analysis of microbial biomass has proven useful in some studies. Assessments based on PLFA, CLLP and/or DNA analysis combined with enzyme substrate utilisation profiles would ideally provide substantial scientific benefits.
- Given the role of hydrology in determining the functioning of peatland ecosystems, monitoring hydrological parameters is likely to be important to gauge the effectiveness of restoration techniques where they significantly affect hydrological processes, either directly or indirectly. Monitoring water levels using dipwells is a straightforward way of establishing how the overall water budget of a site is changing over time and determining the net effect of changes to hydrology. They can be implemented with varying degrees of technological sophistication and at their simplest can be installed very cheaply. Monitoring other components of the hydrology of a site can be more complex and costly but, without monitoring a range of processes to identify causal links between changes in hydrological parameters, it may not be possible to fully assess the effectiveness of restoration techniques. For example, increases in water levels may be due to gully blocking or increased rainfall, or a combination; reduced water levels may be due to increased evapotranspiration as a result of changes to vegetation cover.
- Peat and water chemistry measurements are straight forward and relatively cheap for the amount of information that they provide. Nutrient concentrations, pH and redox potential should be included on every monitoring protocol and monitored at least seasonally every year at different peat depths to provide important information that relates to both plant and microbial functional development on the site. Advantages of these methods are that they are precise and repeatable, provide information necessary to identifying cause of community changes, and give an indication of when things are going to change prior to the change happening permitting remedial action. Disadvantages are that the techniques can be

expensive, difficult to analyse, long-term monitoring requires expensive equipment and specialist knowledge may be required. Subsequent analysis of nutrient ratios may be used as important indicators of nutrient deficiencies that may aid adaptive management decisions.

- Determining parameters associated with the C cycle in peatlands is useful not only for understanding the C budget, but relating C to other parameters may offer deeper insight into the progress of peatland restoration success. Dating methods used for assessing the C budget of peatlands are only capable of measuring past peat accumulation and may not reflect ongoing accumulation. NPP of *Sphagnum* species can be determined accurately using the cranked wire method. Determination of SOM may be useful for long-term studies but will probably not provide useful information in the short-term. Loss on ignition is relatively straightforward and inexpensive. However, CN analysis which is more expensive and time-consuming may be more accurate as well as providing a C/N ratio. Both methods require accurate estimation of the bulk density to provide good estimates of the carbon budget. POC and DOC are major fractions of the C budget in peatlands and should be monitored at least seasonally when possible. The methods are straightforward, and relatively inexpensive but can be time-consuming. These determinations are particularly important for catchment blanket bog with grip management. Restoration of the water table by blockage of drainage ditches has a positive impact on C sequestration in peatlands, and DOC may be a good indicator of that impact and the success of restoration over a sufficiently long time period.
- Determination of greenhouse gas fluxes particularly CO<sub>2</sub> and CH<sub>4</sub> is critical to assessing the C budget of peatlands. The sink or source strength of these gases will also indicate the state of restoration of a peatland. Enclosure techniques are recommended for the majority of restoration projects at small scales and short time periods due to their accuracy, ease of use and lower cost relative to micrometeorological techniques. However, gas chromatographic analysis of gas samples can be expensive and so analysers such as IRGAs with flow-through enclosures are recommended as alternatives as they can be purchased commercially with loggers for CO<sub>2</sub> measurements. Also, a very high number of measured points are needed to sufficiently describe an ecosystem level. However, for large expansive areas of open homogenous peatland restoration sites such as upland blanket bog where considerable academic interest is present may provide support for techniques such as eddy covariance where specialist knowledge is required. Micrometeorological methods provide nondestructive, integrated measurements of gas fluxes over large areas, but may underestimate CO<sub>2</sub> flux as well as not analysing CH<sub>4</sub> or N<sub>2</sub>O flux. Tower-based and airborne eddy flux correlation methods require expensive fast-response sensors and logistical support. Proxies are indirect measures of GHG fluxes that are less expensive and time-consuming. Vegetation reflects long term water level, is controlled by the same factors as GHG emission, is partly responsible for GHG emission and allows fine scale mapping. However, it cannot be used to provide an estimate of GHG with a view to trading on the carbon market, it may take a long time to reflect change, and the method must be calibrated with different climatic conditions.

## 2. INTRODUCTION

Peatland ecosystems have been estimated to contain 329-528 billion tonnes (Gt) of carbon (Immirzi & Maltby et al., 1992). Globally, they occupy only 3 % of total land area (Immirzi & Maltby et al., 1992) but account for approximately one-third of the world's soil carbon (C) stock (Gorham, 1991). The high water table in pristine peatlands leads to a situation where primary production exceeds the rate of organic matter decomposition; therefore they accumulate peat and act as a store of carbon (Kivimäki et al., 2008). However, the hydrology, soils and ecology of peatlands are very sensitive to small changes in the local environment. Moorlands are typical upland peatland or blanket bog in the United Kingdom and thus contribute to the C storage capacity of the UK. Moorland covers around 38 % of Scotland, 5.5 % of England and Wales and 8 % of Northern Ireland (Holden et al., 2007). In many areas these moorlands have been affected by grazing, burning and drainage practice. These forms of management have led to severe degradation with erosion, flooding, poor water quality and loss of ecological biodiversity. In the UK, prior to disturbance, peatlands may have held 2.1 Gt of C in 1.64 million hectares (Mha) of peatland (Maltby et al. 1992). In Ireland, an additional 1.18 Mha may have held 1.5 Gt of C. Bellamy et al. (2005) showed that peat and organic soils have lost carbon an order of magnitude faster than brown soils and man-made soils, and bogs and upland grass lost carbon an order of magnitude faster than lowland heath. In England and Wales, the net loss of heather moors was estimated at 20% between 1947 and 1980 (Anon, 1986). By 1995, moorland was in poor or suppressed condition with 24% and 38% in England and Wales, respectively, at that time showing signs of over-grazing and management neglect (Bardgett et al. 1995). However, since then there have been a number of major changes to policy including AE schemes, Cross compliance, and CAP reform. There continues to remain a great deal of interest in restoring peatland ecosystems to a pristine state, particularly in light of the potential bi-directional feedback relationship between peatlands and climate (i.e. temperature ↔ greenhouse gas flux).

Tackling the problem of ecosystem restoration in general has led to the development of general guiding principles for restoration (Hobbs & Norton, 1996). A continuum of restoration efforts can be recognised, ranging from restoration of localised highly degraded sites to restoration of entire landscapes for production and/or conservation reasons. Hobbs & Norton (1996) emphasised the importance of developing restoration methodologies that are applicable at the landscape scale. Restoration of ecosystems in most cases is rehabilitation to some acceptable state, a state based more on management and public values than scientific foundations (Loomis & Patten, 2005). Management decisions based on 'desired' conditions within the context of historic range of variability may be the ultimate set of guidelines determining the magnitude of restoration activities. As restoration continues, Loomis & Patten (2005) suggest that information and learning be used to assess progress and guide adaptation of methods and goals to ensure better long-term success.

Key processes in restoration include identifying and dealing with the processes leading to degradation, determining realistic goals and measures of success, developing methods for implementing goals and incorporating them into land-management and planning strategies, and monitoring the restoration and assessing its success (Hobbs & Norton, 1996). The concept that many ecosystems are likely to exist in alternative stable states, depending on their history, is relevant to the setting of restoration goals (Hobbs & Norton, 2006). Loomis & Patten (2005) stated that monitoring in river and lake restoration is one of the most needed components of adaptive management, but also one of the most overlooked processes in restoration science. Holl & Cairns (2002) argued that monitoring is essential to assess the success of restoration. In order to determine the success of peatland restoration, ideally monitoring is needed prior to restoration in order to provide a pre-restoration baseline or, if this has not been possible, by comparing monitoring results to a carefully defined control or reference site. Monitoring may be required long after restoration techniques are applied to evaluate responses of the peatland habitat that might not be detectable



until some years or decades later. Not only is monitoring critical to determining the state of restoration within a specific site and informing future strategies for restoration, but the types of data collected could be extremely useful for evaluating the success of restoration techniques more widely and informing an on-going database that could provide restoration managers and researchers with a tool for evaluating peatland restoration. This could substantially reduce the costs inherent to long-term restoration programmes as well as increase our knowledge of restoration ecology on a local, regional and/or national scale. It is monitoring that allows us to learn at every stage of restoration and adjust scientific actions, policy and values when appropriate (Loomis & Patten, 2005).

## **2.1. Aims of technical report and guidance document**

Moors for the Future produced a compendium of UK Peatland restoration and management projects as part of research commissioned by the Peat Project (Walker et al. 2008). To support the assembly of this compendium a conference was held attended by peatland restoration and management practitioners. The conclusions of both the conference and the project report indicated that there were key issues relating to monitoring of peatland restoration which need resolution. Specifically:

- Existing monitoring data was being collected using a wide variety of techniques and approaches, and this may result in difficulties in collating or comparing the results to draw wider conclusions.
- Existing monitoring has concentrated on biodiversity and simple hydrology, with other aspects of peatland restoration being under represented during monitoring.
- Monitoring data collected in individual projects had not been collated or analysed collectively.
- There is a paucity of pre-restoration monitoring, owing to pressure to commence restoration works within a short timescale.
- No current guidance is available on the most appropriate techniques for monitoring the success of different aspects of peatland restoration.

Given the rising interest of the potential impact of peatland restoration on greenhouse gas emissions, as well as the delivery of a wide range of ecosystem services, and the range of different monitoring techniques possible, there was a need for guidance that would allow peatland restoration projects of all scales to collect repeatable, useful and comparable monitoring information on the success of their projects. Also, there was a need to collate current monitoring data in a format which facilitates comparison of monitoring data between projects, to allow this data to be used to develop good practice and inform the approaches of other projects.

This document aims to review common techniques for monitoring the success of restoration of both upland and lowland peatlands that can be built on in the future. This report provides the detailed evidence base for the guidelines presented in the accompanying report. The guidelines document is intended to be as simple and clear as possible to allow a monitoring protocol to be developed by stakeholders with different levels of experience of setting up monitoring strategies. This report focuses on monitoring techniques rather than restoration techniques and therefore an understanding of current restoration techniques being utilised in UK peatlands is expected.

This document has drawn on, and recommends, the information and protocols in the Common Standard Monitoring Guidance for upland (JNCC, 2008) and lowland wetland (JNCC, 2004b) habitats

as well as Schumann & Joosten (2008), Bardsley et al. (2001), Tomàs Vives (1996), NAVFAC (2004), SER (2004), Quinty & Rochefort (2003), Clarkson et al. (2004), Stoneman & Brooks (1997), Perrow & Davy (2002) and Wheeler & Shaw (1995) that each detail aspects of restoration monitoring for wetland ecosystems. In particular, Holl & Cairns (2002) provide monitoring and appraisal of ecosystem restoration. Details on specific monitoring techniques were drawn from Robertson et al. (1998a), Holland et al. (1998), Sala et al. (2000), Davidsson et al. (2000), Grossman et al. (1994), Maskell et al. (2008) and Sutherland (1996).

## **2.2. Peatland restoration objectives**

Restoration is the process of bringing something back that has been lost (Schumann & Joosten, 2008). Ecological restoration assists the recovery of a degraded, damaged or destroyed ecosystem to recreate a naturally functioning self-sustaining system (Wheeler & Shaw, 1995). Restoration can either aim to restore the natural composition, structure and processes, and dynamics of the original ecosystem, or restore ecosystems to a sufficiently productive state to provide ecosystem goods and services to humans (Chapin III et al, 2002, p.360). Restoration has therefore several objectives. It is a key nature conservation objective for degraded habitats. Policy targets are set by the European Habitats and Species Directive (92/43/EEC, 1988) and European Birds Directive (79/409/EEC, 1979), UK Biodiversity Action Plan (BAP) targets and the SSSI PSA target. Restoration can also serve land management interests by enhancing the carrying capacity for agriculture, game management and forestry, the potential for carbon storage and sequestration, regulation of water quality and provision, management of natural hazards such as flood and wildfire risk as well as enhancement of landscape aesthetics and potential for recreation and tourism (after Anderson et al, 2009). The ultimate goal of restoration is to restore the ecological quality and functioning of the habitats within landscapes with full integration of nature conservation and other legitimate land use objectives as well as social and economic objectives (NE/MFF, in prep). This should increase resilience in the ecosystem to absorb impacts through further external and internal drivers (e.g. pollution, climatic variation, fragmentation, invasive species, and disturbance).

Restoration aims to return the degraded system to some form of cover that is protective, productive, aesthetically pleasing, and/or valuable in a nature conservation sense. It must also consider the integrity of the substrate itself, which is integral to the ecosystem, and may be the source of interest (e.g. carbon, archaeology). A prerequisite for achieving this is returning the peat substrate to a functioning condition. A further aim is to develop a system that is sustainable in the long term with regard to its requirements for ongoing management.

Within the survey of 56 peatland management and restoration projects within the recent UK Peat Compendium (Walker et al, 2008) most projects focussed on restoring ecological and hydrological function, or whole ecosystem function. In terms of project justification, biodiversity came across overwhelmingly strongly and was used as a justification for all projects. This is likely due to the SSSI PSA target as strong policy and funding driver to get 95% of SSSIs into favourable condition by 2010. Hydrological function and carbon storage were stated as the second and third most important justification factor respectively. Given the new cross government Natural Environment PSA28 target “to secure a diverse, healthy and resilient natural environment, which provides the basis for everyone’s well-being, health and prosperity now and in the future; and where the value of the services provided by the natural environment are reflected in decision-making”. This sets out the government vision to embrace an ecosystem approach, and therefore future restoration targets are likely to include a broader spectrum of targets for multiple benefits next to biodiversity conservation.

### 2.3. Why monitor peatland restoration success?

Wheeler & Shaw (1995) state several reasons why it is important to record and monitor progress in peat restoration:

- All schemes must be regarded as essentially experimental, and therefore recording is important in increasing the knowledge of techniques;
- Provision of 'baseline' data so that progress can be assessed and changes to the programme made where necessary;
- Provision of 'hard' data so that current and future managers know the starting conditions, exactly what has been done and can continue to assess the degree of success, in order to formulate appropriate further management strategies;
- Provision of information that can be used to assess the applicability and potential of similar schemes at other sites.

Monitoring is a necessary step in the restoration process to assess how successful restoration and management activities have been in achieving objectives, goals or targets, both on individual sites and across site series as a whole. This permits active management to address specific issues or objectives that have not been met within a specific time frame to achieve those future goals at a later stage. Monitoring can provide the information necessary to undertake these assessments of goals and targets. However, objectives, goals and targets are not necessarily attributable to restoration success and an understanding of the ecology of restoration is required to assess the degree of success. For example, restoration of the water table level may not always lead to the reestablishment of target species along a desired gradient of succession and therefore monitoring of vegetation patterns and associated ecosystem processes may identify positive or negative trends and potential issues of restoration.

As another example, if the objective of restoration is to reduce the production of greenhouse gases, restoration of the water table and reestablishment of vegetative cover may be used as a proxy to indicate a reduction in greenhouse gas flux (see Couwenberg et al. 2008). Whilst it can predict a reduction in greenhouse gases due to variation in proxies, it cannot accurately and precisely determine greenhouse gas fluxes for carbon trading or national emission inventories. Thus the monitoring techniques used must be closely related to the restoration goals and objectives. On a separate note, determination of actual greenhouse gas fluxes at a national scale for all peatland restoration projects would provide significant data for validation of proxy based methods as well as accurate data for carbon trading and national greenhouse gas inventories. Thus we would recommend that primary monitoring techniques are considered over proxies or indicators where expenditure is not an issue.

Monitoring is necessary to:

1. Determine that the objectives of restoration have been achieved;
2. Assess management impacts in the wider context and contribute information to other projects and the scientific community;
3. Generate results which can be used to communicate the success of the project to public and partners.

### 2.3.1. Alternative stable states and thresholds

Restoration aims to return a degraded system to a desired state by accelerating biotic change or reinstating successional processes (Luken, 1990; Edwards et al. 1993). The restoration process directs the development of the system along a desired trajectory (Fig. 1; see also Dobson et al. 1997). Aronson et al. (1993) defined restoration as “endeavors that seek to halt degradation and to redirect a disturbed ecosystem in a trajectory resembling that presumed to have prevailed prior to the onset of disturbance.” However, restoration trajectories rarely approximate to natural trajectories that existed prior to degradation (Zedler & Callaway, 2002). A remedial trajectory is usually followed and once the habitat has recovered, a management trajectory is established. Ecosystems may not always undergo ordered and predictable, gradual development but rather undergo rapid transitions between different stable states (Klötzli & Grootjans, 2001; Drake, 1990; Hobbs, 1994). Such stable states are the result of positive feedback mechanisms that stabilize a certain development stage (Holling, 1973; Scheffer, 1998). A positive feedback switch occurs when a certain vegetation state modifies its environment in such a way that it becomes more favourable for itself and can persist for a long time (Klötzli & Grootjans, 2001).

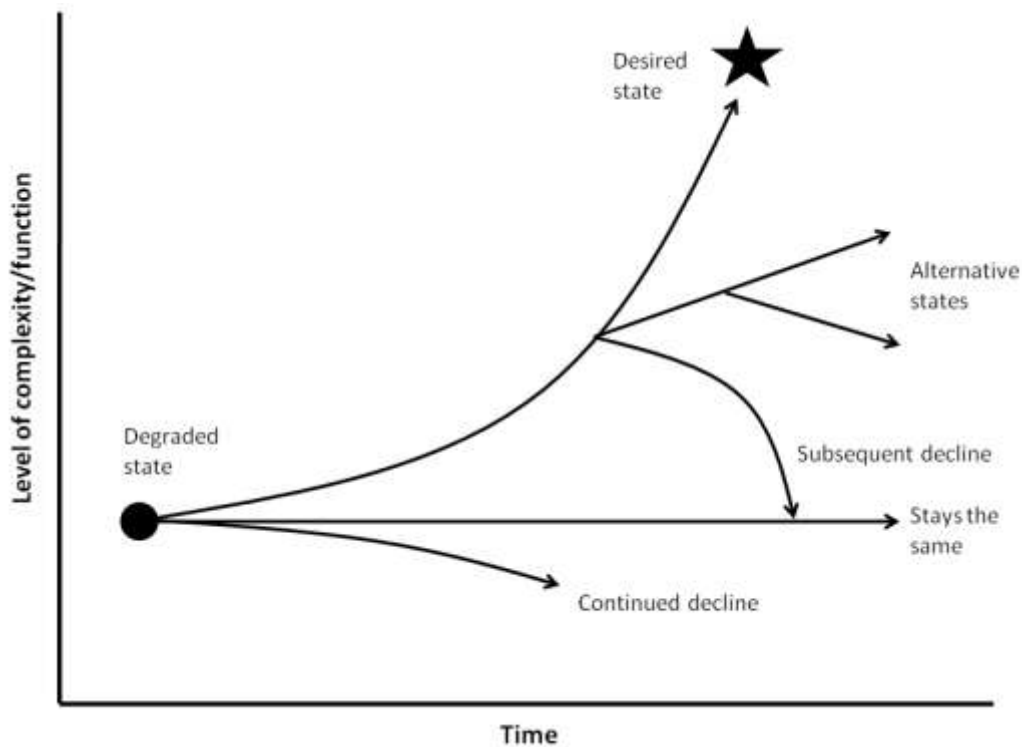

**Figure 1** Traditional view of restoration options for a degraded system, illustrating the idea that the system can travel along a number of different trajectories and that the goal of restoration is to hasten the trajectory towards some desired state. In this view, the past history of the system is not considered, yet the route by which the system reaches the present point can have a large impact on the potential for restoration (Hobbs & Mooney, 1993; Hobbs & Norton, 1996).

In past restoration projects, very persistent semi-stable states were considered as obstacles, because the goal of restoration was a full regeneration of a former reference state (Wheeler & Shaw, 1995). Such transitions indicate non-linear and threshold responses to management and environmental factors, with the occurrence of particular states depending on particular combinations of driving

factors (Hobbs & Norton, 1996). Indeed, transitions leading to increased degradation may be easier to force than transitions desired to restore systems, due to the presence of pronounced system thresholds (Aronson et al. 1993). Once a system crosses a threshold, it may require significant management inputs to restore it to its original condition (Hobbs & Norton, 1996). Restoration can be viewed as an attempt to force transitions towards a desired state, and therefore requires an understanding of the variables that need to be manipulated to achieve these transitions. Luh & Pimm (1993) pointed out the possibility that restoration may produce a persistent community that may not be the desired community. Thus, consideration of the potential for alternative stable states is important when setting restoration goals and objectives. A bog restoration project in the Schierhorner Moor in northern Germany is a good example of the occurrence of such long-lasting intermediate stages (Klötzli & Grootjans, 2001). After raising the water table in an old pasture with *Alopecurus geniculatus* (marsh foxtail) in 1985, *Juncus effusus* (soft rush) became the dominant species and *Carex rostrata* (bottle sedge), *C. canescens* (gray sedge) and *Agrostis stolonifera* (creeping bent) were very abundant. *Sphagnum* species and *Polytrichum commune* reached the restoration area within three years and spread over approximately 1 ha, even beginning to form hummocks. Then the succession toward bog vegetation stopped. A stable state with small sedges and *Sphagnum* mats under the shade of tall *J. effusus* persisted for many decades. Klötzli & Grootjans, (2001) suggested that *J. effusus* has a similar strategy to dominate the vegetation as tussock species, such as *Molinia caerulea* (purple moor-grass) and *Eriophorum vaginatum* (hare's tail cotton grass) that can coexist with *Sphagnum* swards for long periods of time. Kooijman and Kanne (1993) reported on the occurrence of semi-stable states in a fen restoration project. They showed that *Sphagnum fallax* and *P. commune* rapidly expanded in pioneer stages of eutrophic terrestrializing fens and formed a vegetation stage, which was stable for at least 10 years. However, such stable states may function as a necessary stage towards a final target stage.

Environmental thresholds are the tolerance points at which the conditions necessary to maintain a prevailing ecosystem state are exceeded. This may lead to a shift between alternate equilibrium states. It is important to realise, however, that these alternative states may be equally 'stable' but represent the preference of different stakeholder groups at least in part because of different functional characteristics.

## **2.4. Evaluating restoration success**

### **2.4.1. Reference states**

Restoration efforts seek to restore damaged systems to a defined indigenous ecosystem that resembles the original in a number of aspects. This strict definition of restoration is handicapped by ambiguous goals and criteria for success (Aronson et al. 1993). Because we seldom understand the composition, structure, function, or dynamics of historic ecosystems, it is difficult to measure success against such models (Hobbs & Norton, 1996).

The idea of "natural" communities and ecosystems is commonly stated but it is not always clear what this means in the context of peatlands that have been created and developed due to anthropogenic impacts on the environment. For example, many upland peatlands are probably the result of deforestation by man at the end of the last glaciations approximately 10,000 years ago as well as climate change (Charman, 2002). Also, the continual management of upland moorland for grouse shooting has supported the persistence of heather communities. The true natural state of these areas without intervention by man may be different to the intended goal of restoration. Even more important, climatic and environmental change make it potentially impossible to restore these

systems to a pre-defined target (see, for example, the apparent cycling between *Calluna vulgaris* and *Molinia caerulea* on some upland blanket peatlands based on paleoecological data, Chambers et al., 1999). Thus the setting of specific reference conditions as goals maybe unrealistic if the reference system itself were the product of specific past environmental and management events (Hobbs & Norton, 1996). Many restoration projects are focused on unattainable goals relating to restoring some historic natural condition, an approach that is unrealistic, unachievable and static. There is a requirement for goals that are dynamic and that take into account the changing nature of the environment (Hobbs & Norton, 1996). As stated above, the goal may be to enhance ecosystem functioning for different ecosystem services, which may not require a return to ‘original’ conditions in the full. The evaluation of long-term permanent plots provides not only more insight on their specific dynamics (Herben, 1996), but unexpected peculiarities may also lead to questioning of ecological theories or formulation of new ecological concepts. For example, Klötzli & Grootjans (2001) as described in Section 2.3.1.

For each ecosystem attribute, there needs to be a clear set of defined objectives and goals for particular time periods. For instance, which attribute do you consider to be the most important – structure, function or composition? How do we measure or monitor the redevelopment of the attributes for comparison with reference ecosystems? Some suggested measures include similarity indices between the restored system and some reference system, the use of indicator species such as *Sphagnum*, and some estimate of system response in relation to resilience measures (Kondolf, 1995; Cairns, 1989; Berger, 1991; Westman, 1991). Costanza et al. (1992) proposed using a range of structural, compositional and functional measures for estimating ecosystem health. Ecosystem state could be assessed in a similar way relative to the natural variability of a number of different parameters, as has been used for the measurement of ecosystem health in some North American forests (Fig. 2 ; Caraher & Knapp, 1995). For example, a variety of hydrological parameters could be assessed relative to known variation in these parameters within reference sites. Alternatively, where the functions of the peatland are deemed important a number of different parameters could be specified such as water level, *Sphagnum* cover, pH, and nutrient status. While these approaches aim to assess the success of ecosystem management, they could equally well be applied to restoration, where the aim is to return the target parameters to a predetermined range (Hobbs & Newton, 1996). For more information on selecting reference sites see Holl & Cairns (2002).

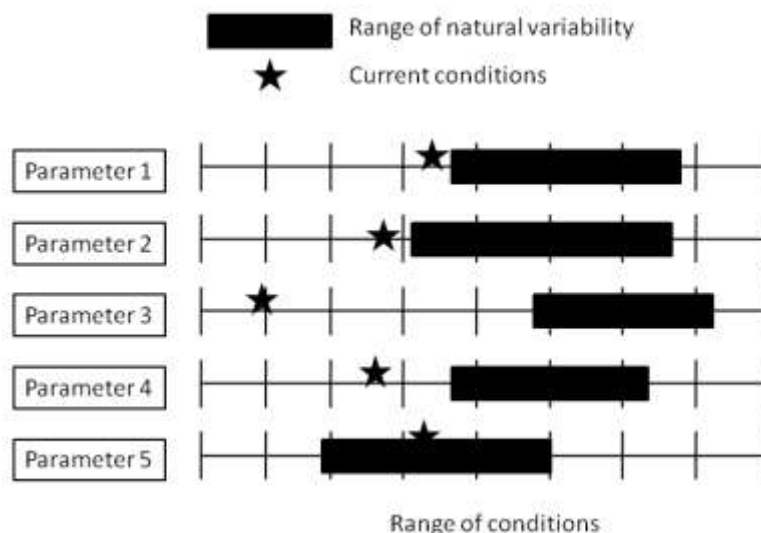

**Figure 2** A restoration “scorecard” in which the current condition of a number of key parameters of the restored ecosystem is assessed relative to the estimated range of natural variability (from Caraher & Knapp, 1995; Hobbs & Newton, 1996).

#### 2.4.2. Species as indicators of success

Habitats are often described in terms of the species or communities of species found there. Therefore, changes in peatlands can be assessed by monitoring the species status that inhabits them. Species that can be used to monitor the status of a peatland are (Bardsley et al. 2001):

- Definitive species – These are species used to define habitat.
- Integral or “keystone” species – These are species that contribute to the form and physical nature of the habitat, for example, *Sphagnum* mosses build the structure and form the peat associated with bog habitats.
- Dominant species – These are species which dominate communities and may be used to define habitats.
- Characteristic species – These are species consistently found within a habitat.
- Indicator species – These are species that react to particular aspects of the habitat quality, for example, certain aquatic invertebrates are very sensitive to water pollution and are therefore indicators of water quality . Blooms of algae can be caused by nutrient enrichment and can therefore be used as an indicator of nutrient status.

Indicator species or functional indicators can be used to assess the condition of a peatland. Suitable indicators would typically include species characteristic of a range of different micro-habitats, and, if possible, conspicuous species that could be recorded by a non-specialist. Examples include *Sphagnum* which indicate reestablishment of the water table depth or the hydrological regime (see Wheeler & Shaw, 1995; O’Reilly, 2008), and invertebrates that can indicate water quality or conservation value (e.g. Scott et al., 2006).

### 3. FRAMEWORK FOR DESIGNING A MONITORING PROTOCOL

Monitoring may be defined as the collection and analysis of environmental data (biological, chemical, and/or physical) over a sufficient period of time and frequency to determine the status and/or trend in one or more environmental parameters toward meeting a management objective (Elizinga et al. 1998).

The JNCC (2004a) define monitoring as:

*An intermittent (regular or irregular) series of observations in time, carried out to show the extent of compliance with a formulated standard or degree of deviation from an expected norm.*

In line with this definition, a description is required of the desired state of the restored peatland in terms of objectives, goals or targets, and monitoring is undertaken to determine whether those goals have been achieved within a specific time frame.

Monitoring is distinct from surveillance, which is a repeated survey using a standard methodology over an extended period of time but without a specific objective in mind. This type of monitoring (or surveillance) is used by the acid waters monitoring network and is also used in long-term monitoring programmes such as the Environmental Change Network at Moorhouse NNR. They are generally designed to determine whether significant change has occurred and help to indicate the underlying cause. Whilst those data provided are useful to determine relationships between variables, they do not establish whether objectives have been met based on specific pre-determined criteria. A monitoring protocol may consist of a framework that goes beyond specifying only the monitoring techniques and targets, and includes objectives, goals, criteria, protocols, cost/benefit analysis, monitoring and evaluation of success (Fig. 3).



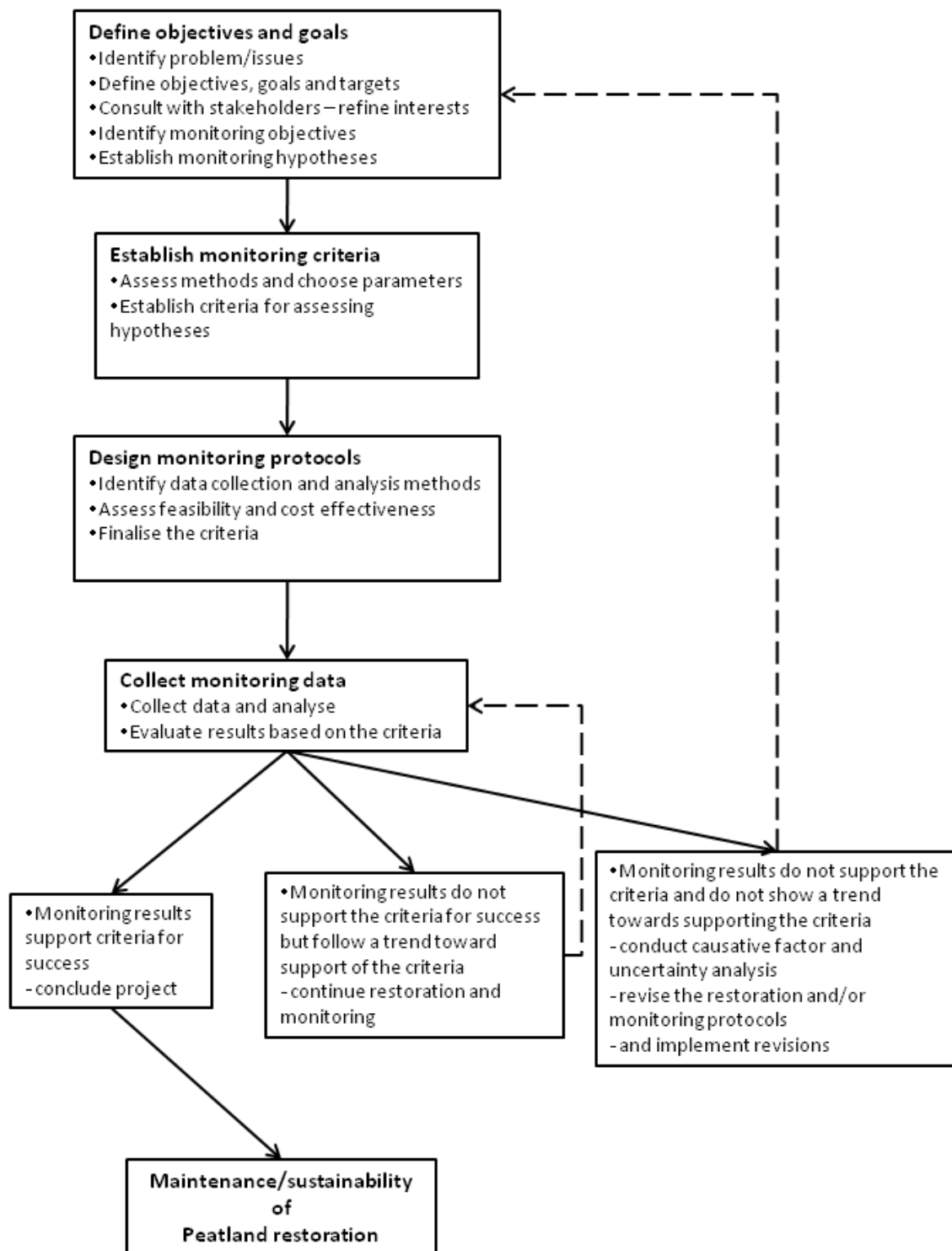

**Figure 3** Framework for designing a monitoring protocol.

### 3.1. Defining objectives of restoration and monitoring

#### 3.1.1. Identify restoration objectives

Hobbs & Norton (1996) identified a number of key processes in restoration ecology that they considered essential for the successful integration of restoration into land management:

- 1) Identify processes leading to degradation or decline.
- 2) Develop methods to reverse or ameliorate the degradation or decline.
- 3) Determine realistic goals for re-establishing species and functional ecosystems, recognizing both the ecological limitations on restoration and the socioeconomic and cultural barriers to its implementation.
- 4) Develop easily observable measures of success.
- 5) Develop practical techniques for implementing these restoration goals at a scale commensurate with the problem.
- 6) Document and communicate these techniques for broader inclusion in land-use planning and management strategies.
- 7) Monitor key system variables, assess progress of restoration relative to the agreed goals, and adjust procedures if necessary.

Restoration measures that do not ameliorate or reverse the processes causing degradation may not work as hoped because the degrading influences will continue to operate and work against restoration efforts (Hobbs & Norton, 1996). However, it was suggested at a meeting of experts at the Natural England peat restoration workshop that most peatland restoration projects are at the stage of peat stabilization and have not yet begun true restoration (Appendix 2). Many restoration projects have proceeded with only the broadest of objectives, often with little consideration of whether these objectives are attainable, and with no means of assessing the degree to which the objectives have been met. Monitoring methodologies developed for restoration projects also have been largely ad hoc and site-specific, and there has been little attempt to generalise from one site to another (Berger, 1990). The drivers for restoration in recent years have been the government's public service agreement (PSA) to have 95 % of the SSSI area in favourable or recovering condition by 2010, SAC and SPA management driven by the Habitat Regulations, Biodiversity Action Plans (BAP) and Higher Level Stewardship (HLS) targets. It has been mentioned that one objective of restoration should be to aim to restore the functions attributed to biogeochemical processes in wetlands rather than short-term gains in biodiversity since functions support the goals of restoration such as *Sphagnum* growth and development and carbon sequestration (Appendix 2). The results of a survey on restoration monitoring (Appendix 1) showed that of the 29 projects biodiversity, conservation status (e.g. BAP), and vegetation cover/composition were deemed the most important for instigating the project followed by hydrological parameters and carbon storage/sequestration. The importance of restoration purpose was obvious from results presented for Wicken Fen at the Natural England conference (Appendix 2) that showed that standing water above the soil surface was required to increase the soil carbon (C) store, but that this environmental condition was adverse to the situation required by the BAP for the habitat. Also, the question was raised whether restoration should aim for the most sustainable habitat rather than the most bio-diverse. As an example, it was suggested that bunded grazing marsh would be better at Wicken Fen than fen or bog as that type of wetland would be more sustainable in the long-term (Appendix 2). Agreement was reached that no loss of peat or

chemical change in the peat was a common restoration objective which may not be achievable in practice and that the objective of restoration needs clear definition prior to even pre-restoration monitoring.

A properly planned restoration project attempts to fulfil clearly stated goals that reflect important attributes of the reference ecosystem (SER, 2004). Goals are attained by pursuing specific objectives. The goals are ideals and the objectives are the desired results of actions taken to attain those goals. In the case of peatlands, Quinty & Rochefort (2003) state that the goal of current restoration is often to re-establish self-regulatory mechanisms that will lead back to functional peat accumulating ecosystems. Peat will not accumulate during the short-term period of restoration. However, the objective in the short-term is to establish plant communities which will eventually in the long-term (10-100 years) produce debris that will accumulate and become peat. Dead plant parts will accumulate only if the water table is high enough throughout the year to impede decomposition, and a restoration target identified some years ago for important peatland sites was to retain rainwater within 10 cm of the peat surface for ombrotrophic peatlands, and reduce seasonal fluctuations (Johnson, 1997).

Objectives are linked to activities that produce measureable results that determine or indicate if a site develops toward successful restoration (Quinty & Rochefort, 2003). For example, the approach to peatland restoration developed in Canada, has two specific objectives:

1. Re-establishing a plant cover dominated by peatland species including *Sphagnum* mosses, and
2. Re-wetting harvested sites by raising and stabilizing the water table near the surface.

These two specific objectives focus on peatland vegetation and the hydrological regime because they are the key factors responsible for most functions of peatlands as well as being the principal elements affected by degradation such as peat extraction (Quinty & Rochefort, 2003). However, this example relates to restoration of raised and blanket bogs in Canada and objectives can differ between habitats and countries. The principle restoration methods in lowland peat are blocking drains, felling trees, raising ground water levels, landscape change and reducing cover of purple moor-grass (Appendix 2). In some cases objectives might be synergistic or contradictory, such as management for biodiversity, carbon storage and greenhouse gas emissions. For example, re-wetting through ditch blocking in upland peat bogs, for instance, may enhance biodiversity but may also lead to increased methane emissions. At Wicken fen, restoration is occurring but there is no remaining mire vegetation present, leading to discussion as to whether restoration or re-creation was the objective. It is therefore important to implement an ecosystem approach by considering all objectives carefully and assessing also their effects on other ecosystem services. More details on setting restoration goals and objectives can be found in Quinty & Rochefort (2003), and Schumann & Joosten (2008) as well as from the survey results presented in Appendix 1; Q5 for each restoration project surveyed.

### 3.1.2. Identify monitoring objectives

In this section, we consider the monitoring objective to be a target level of a particular monitoring parameter that indicates that the objective of restoration has been met. Goldsmith et al. (1991) suggest that monitoring can be considered at a number of levels, for example:

- Site level mapping to ascertain different vegetation types with relation to geomorphology and hydrology, and to identify areas that retain species or assemblages of particular interest.
- Quadrat based techniques within identified areas, which can include:
  - Fixed quadrats and fixed point photography.
  - Random quadrat approaches – stratified, along transects, and/or nested to account for different vegetation types.
- Monitoring of weather and climate that extends beyond the site boundary

For peatland restoration, Bardsley et al. (2001) suggest three phases of monitoring. The initial phase monitors the site prior to restoration providing a baseline or control to assess restoration success (pre-restoration monitoring); the second phase monitors the success over a period after restoration (post-restoration) on the environmental conditions of the site; and the third is required to establish the effectiveness of longer-term site management and/or sustainability of restoration in terms of the biogeochemical functioning of the site. Ideally, the restoration objectives can determine the goals for setting monitoring objectives. If restoration objectives are to achieve a specific level of ecosystem functioning, then the monitoring objective will address the attribute, indicator or criteria of ecosystem functioning (e.g. species present, water table depth).

A secondary purpose of monitoring objectives may be what the monitoring programme will achieve in terms of provision of information about a site. In setting up a monitoring programme, Usher (1991) suggested the following questions need to be addressed:

- Purpose: what is the aim of the monitoring?
- Method: how can this be achieved?
- Analysis: how are these data, which will be collected periodically, to be handled?
- Interpretation: what might these data mean?
- Fulfilment: when will the aim have been achieved?

It may be wiser to relate the monitoring objectives to the restoration goals rather than a wide range of parameters. For example, if the goal of restoration is to restore the water table level, then monitoring could focus on the water table itself and/or a number of hydrological parameters or vegetation indicators of water table depth (i.e. the percent cover of *Sphagnum* increases, *Calluna* decreases) (see Appendix 1). However, if restoration goals are more complex such as to restore ecosystem functioning, a wider variety of parameters might be required for monitoring such as *Sphagnum* cover, NVC dynamics, nutrient status as well as hydrological parameters as ecosystem functions are dependent on a number of interactive biogeochemical processes. An understanding of the biogeochemical processes that affect the ecosystem function is therefore required to evaluate which parameters are most appropriate to measure. In some cases, the scientific literature may provide evidence that specific parameters relate closely to an ecosystem function. For example, the function of carbon sequestration is determined by a variety of abiotic and biotic factors or processes that interact over time. It would be impossible to monitor all of them and would not necessarily provide useful information without modelling techniques. However, key processes are known to relate to C sequestration such as primary productivity, DOC and gaseous C flux that are relatively simple to measure (see sections 4.8 and 4.9; Worrall et al. 2009). Alternatively, the goals may be

broken down into a series of smaller, possibly shorter term objectives that lead the site to the final goal and enable those evaluating the monitoring to identify that the restoration is moving the peatland toward the goal over time. Examples of relating restoration objectives to monitoring objectives for specific restoration goals are provided in Table 1.

**Table 1** Examples of relationships between restoration objectives, monitoring objectives and techniques

<b>Rationale</b>	<b>Restoration Objective</b>	<b>Monitoring Objective</b>	<b>Monitoring technique / protocol</b>
Sequester carbon	To prevent further loss of fen peat carbon, and re-establish carbon sequestration and net negative emissions of GHGs.	CO2 flux values are negative, and emissions of CH4 and N2O are low enough not to counteract CO2 benefits	Gas collars established at 20 locations across site, with headspace sampling taking place monthly for 1 year prior to restoration and following restoration for 3 years.
Improve biodiversity	To develop 50% of site into fen, 25% into shallow open water habitats and 25% into grazing marsh.	45% of site has fen NVC class, 25% has vegetation typical of grazing marsh and 25% is open water	NVC survey of 200 grid-based sample points, on fen/marsh area to establish vegetation type, conducted once a year during July.  GPS mapping of extent of open water, to be conducted following restoration, and repeated every 2 years until

Common Standards Monitoring (CSM) was developed by the Joint Nature Conservation Committee (JNCC) for monitoring conservation activity on SSSIs and analysis of the resulting information (Crowle & McCormack, 2009). CSM defines favourable condition when objectives are being met for European interest features in the UK, and can include physical aspects of the SSSI, vegetation type/condition and the presence of certain species (both flora and fauna) depending on the feature of interest being assessed. Unfavourable condition is indicated when features are currently in unsatisfactory condition and may decline or recover, i.e. move away or towards desired states or not change. The CSM for upland and lowland wetland habitats (JNCC, 2004a; 2004b; 2008) provide monitoring objectives that may be applicable to peat restoration projects. These objectives contain target values or ranges which are met if the feature is to be judged to be in favourable condition. Each interest feature will have one or more measurable characteristics that together can be used to define favourable condition. These attributes will either describe the condition of the interest feature directly or be good indicators of its condition. The choice of target range in relation to favourable condition is critical. It is important to relate these to the feature under consideration. However, the targets set by the CSM are aimed at maintaining SSSI habitats and features. Many peatland restoration projects are below the minimum criteria for favourable condition and the method may not be able to identify small scale changes that indicate the slow process of restoration. Results of a survey on monitoring

techniques used in restoration projects in England and Wales provide examples of objectives that have been used for determining the success of restoration (Appendix 2; Question 14).

### **3.2. Pre-restoration monitoring**

Bardsley et al. (2001) recommend that pre-restoration monitoring should consist of site appraisal as a minimum such as legal or planning considerations, site size and location, existing biodiversity value of the site, and physicochemical properties of the site. Wheeler & Shaw (1995) suggested that any preliminary surveys of topography, hydrology and biological interest of the site made prior to the start of restoration measures could act as a baseline for monitoring. Experts at the Natural England workshop on peatland monitoring techniques, run as part of this project for assessing restoration success, suggested that baseline data from pre-restoration monitoring was key to evaluation of restoration success (Appendix 2). However, there can be drawbacks to the use of such data when there have been changes in methodology which affects the precision of estimates and the validity of comparisons.

Pre-restoration information gathered can help to determine an appropriate monitoring strategy, for example, by identifying areas, species, communities, etc. to be specifically targeted. However, under many circumstances restoration works begin prior to monitoring and thus reference sites must serve as a baseline. This may require extra monitoring (such as increased replication) to account for variation between sites. A large number of projects in the Peat Compendium include pre-restoration monitoring although this was dependent on planning, funding and collaboration of academic research (Appendix 1; Q9).

### **3.3. Establish monitoring criteria**

In order to evaluate the functional status of restored ecosystems, it is imperative to establish reliable criteria that will help to assess the success or failure of a given restoration project, and to set realistic and appropriate goals beforehand (Erhenfeld, 2001). The objectives of restoration are typically assessed against specific criteria or standards (SER, 2004). These criteria are based on an understanding of the reference peatland condition that is the goal of restoration and draws on the existing understanding of how a peatland system is likely to respond in a broad way to the main restoration techniques applied (Johnson, 1995). The criteria provide an empirical basis for determining whether or not project objectives have been attained. Clearly, the goals, objectives and criteria must be stated prior to implementation of restoration. The criteria described here have been compiled from a number of sources including the JNCC (2004a).

- **All criteria must be measureable, so that targets can be set as part of the restoration objectives.**
- **Criteria should describe the condition of the feature and not the factors which influence it – in general, restoration activities are not suitable criteria.**

There are a wide range of suitability criteria. For example, habitat criteria may include extent, floristic composition, vegetation structure, and physical characteristics; species criteria may include population size, distribution, diversity and habitat factors. For habitat interest features, floristic or vegetative criteria have generally been used as indicators of the condition of the habitat. However, the requirements of animal species may also be important. This includes suitable habitat criteria,

such as microhabitat and microclimate conditions (vegetation structure, soil moisture), but also availability of food sources (plants or prey and their habitat requirements), and breeding sites (host plants, nest sites etc). Habitat requirements may change throughout the reproductive cycle, and many animal species require a habitat mosaic to serve different needs during the reproduction circle (mating sites, breeding habitat, foraging habitat for juveniles and for mature individuals within the differing home ranges). Other objectives are the removal of disturbance factors, such as sources of pollution, vegetation damage or soil compaction, and the control of invasive species or sometimes predators.

Dargie (2003) guards against becoming too focussed on the final 'end point' of the restoration, but suggests that while an overall aim is very useful in setting out the project scope initially, targets should focus on short term achievements along with longer term goals. This ensures the information on what is occurring on a peatland site during its restoration towards the 'end point' is not lost.

### **3.4. Design the monitoring protocols**

For some sites such as SSSIs, the parameters to monitor will be identified by the special interests for which the site was designated. However this is not always a simple option. Many SSSIs are designated for their species assemblages. Estimating the population trends for a range of invertebrates, for instance, would be enormously resource intensive. What are the limits of acceptable change for a species assemblage? Choosing standards or criteria is one of the most difficult parts of monitoring as it requires an in depth knowledge of the species or habitats involved. The number of plots, size of plots and number of replicates to take within each plot are also difficult questions to be answered, depend on site characteristics as well as the monitoring parameter. Some parameters or variables such as vegetation only require monitoring once per year as the percentage cover varies little, although increased replication will increase accuracy whilst the number of plots and replicates will affect the final result. Parameters such as physicochemistry and greenhouse gas exchange vary greatly with seasons and therefore require monitoring weekly or monthly or at least seasonally. The amount of replication therefore depends principally on the restoration objectives and the size of the budget for monitoring. A minimum of 4 or 5 replicates is suggested with an upper limit determined by costs vs. benefits. However, some parameters particularly microbiological processes will require more replication.

Monitoring objectives, methods and periods of assessment have to be adapted to the individual characteristics of each project (see Schumann & Joosten, 2008). However, the time of sampling will depend on the attribute being monitored and the techniques applied. Where possible, Wheeler & Shaw (1995) recommend that a monitoring programme be set up taking the following aspects into account:

- Careful recording of management operations undertaken (including time taken and costs);
- Base-line data on flora, fauna and water levels (based on field investigations, but with additional detail if possible);
- Selected species or priority areas, plus species of special conservation status identified for regular monitoring checks to assess response to management operations;
- The hydrological and biological response within a representative selection of areas to be regularly monitored;

- Dipwells or staff gauges inserted at key points for monitoring of water levels;
- Photographic record, for example:
  - 'fixed point' photographic records of selected representative areas, including 'before' and 'after' pictures and regularly thereafter;
  - Selected management operations (such as bund and dam construction)
  - Ground-based stereoscopic photographs (Lindsay and Ross, 1993)
- Regular checks to be made on any water control structures and remedial action taken as necessary;
- Records made of events beyond the control of site managers (e.g. heavy storms, fires etc.) which may influence the future interpretation of 'success' of the project;
- Annual review of results to allow assessment of any changes needed to management programme.

Over the long term, monitoring can improve peatland restoration methods by contributing to a national database that can help identify factors responsible for the success or failure of restoration by comparing different sites (see Appendix 3 on the accompanying electronic database structure). To do so, consistent and standard information on site conditions and restoration procedures must be collected. It is important to use the same monitoring method to ensure that data from different sites can be compared. Consistency is the key for reliable monitoring data and the principal cause of irregularity is the human factor. It is paramount to allow the most appropriate resources for monitoring. This means having the same people doing it year after year and that they be trained to identify species and properly understand the methods being used. It is often worthwhile to hire a specialist to do the monitoring (Quinty & Rochefort, 2003) such as utilizing the skills and funding of academic research via partnerships with universities. Examples of research attractive to universities and institutes include Artz et al. (2008), Anderson et al. (2006) and Scott et al. (2006).

#### 3.4.1. Site characteristics

Davidsson et al. (2000) suggested that the location of the peatland in the landscape should be considered when designing a monitoring programme as it strongly influences ecosystem functioning e.g. hydrology, topography, geology, land management. Knowledge about interrelationships between the peatland and the surrounding landscape is important for the success of peatland restoration as well as for the protection of natural, presently undisturbed peatlands. Catchments and sub-catchments relevant to the peatland may have to be distinguished. In general, it is necessary to know the origin of the inflowing water, flow paths in the landscape and possibly the fate of the water leaving the peatland if such factors as flood events and water quality of potable water sources are deemed important. For both, the setting-up of a monitoring programme and the evaluation of the results, information about the catchment geology, geomorphology, vegetation and land-use would be useful.

Describing the site characteristics in terms of the broader landscape helps place the peatland in the local and regional (and in some cases, national or European) context. Wheeler and Proctor (2000) provide a useful summary of north-west European mire terminology and propose a 'framework'



within which different mire types can be placed based on ecological variation. They identify the most important sub-division of peatlands as being the difference between bog and fen habitats, based largely on waterchemistry and vegetation types. The importance of the variation in base status is further underlined by Proctor's (1992) evaluation of regional and local variation in peatland water chemistry, in which analysis of data from 193 mire water samples from Britain and Ireland shows a natural subdivision falling on the line between rich fen and poor fen and bog.

Taken together, this research indicates that bogs and poor fens generally have pH values < 5, and low Ca<sup>2+</sup> concentrations (<10 mg l<sup>-1</sup>), with Cl<sup>-</sup> and SO<sub>4</sub><sup>2-</sup> as the main anions. Rich fens in contrast, are characterised by pH values >6.0, and much higher concentrations of Ca<sup>2+</sup> and HCO<sub>3</sub><sup>-</sup> (up to 60 – 120 mg l<sup>-1</sup>) (Table 2). Peatland types that are around the mid-values in terms of pH and Ca<sup>2+</sup> concentrations are often termed 'transitional mires' (Shaw and Wheeler, 1991) and selected examples of these habitats are classed as 'transition mires and quaking bogs' under Annex 1 of the Habitats Directive. This base-poor to minerotrophic gradient is usually defined by the incoming ground-water and is generally relatively independent of land-use and most sources of nutrient enrichment. Rich (i.e pH >6) fens can, however, vary along a wide gradient nutrient enrichment, in terms of the availability of plant nutrients, principally N and P, defined as an oligo/meso/eutrophic gradient. The most nutrient limited fen communities usually consist of open-field layers of small calcicole sedges and forbs with a more or less prominent ground-layer of "brown" mosses. With increasing nutrient levels a more vigorous field layer develops and the bryophyte ground layer is progressively excluded. This leads in turn to tall sedge/herb communities and highly eutrophic and species poor "reed fens".

**Table 2** Summary of the key characteristics of peatland habitats

Habitat	Nutrient status	pH	Ca <sup>2+</sup> mg l <sup>-1</sup>	Buffering ions	Vegetation type	Main NVC Type
Bog	Oligotrophic	<5	1 – 10	Cl <sup>-</sup> , SO <sub>4</sub> <sup>2-</sup> , and humic acids	Ombrotrophic raised and blanket bog	M17 - M20
	Mesotrophic	<5	1 – 10	Cl <sup>-</sup> , SO <sub>4</sub> <sup>2-</sup> , and humic acids	<i>Molinia</i> bog Acid rush pasture	M25 M23
Fen	Oligotrophic	>6	10 – 100	Bicarbonate system	Small sedge fen	M10, M13, M14
	Mesotrophic	>6	10 – 100	Bicarbonate system	Fen meadow Tall herb fen	M22 M24, M26
	<i>Eutrophic</i>	>6	10 – 100	<i>Bicarbonate system</i>	<i>Tall sedge fen</i> <i>Wet Woodland</i> <i>Swamp</i>	<i>S1, S3, S7, S11</i> <i>W6, W7</i> <i>S1, S23, S27, S28</i>

In addition, the Common Standards Monitoring Guidance for Upland Habitats (JNCC 2008) and Lowland Wetlands (JNCC 2004b) provide useful summaries of the eco-hydrological/topographical

classification of peatlands, based on Guidelines for the Selection of SSSIs (NCC 1989). These descriptions and explanations can provide useful 'working' definitions/descriptions of peatland sites for the site manager and use widely recognised terms that can aid communication between practitioners of peatland restoration. Wheeler et al. (2004) undertake a similar but more detailed assessment and classification of the lowland wetland communities, including wet meadow, fen, reedbed and swamp habitats, for the Anglian Region of England. In this report the ecohydrological requirements of examples of each vegetation community in the region is assessed in order to aid the evaluation of hydrological management in the area and identify potential effects of SAC and SPA areas. Although the report covers a specific area it is extremely useful and clear information on the ecohydrological character of different wetland types that could be applied more widely across the peatlands of Britain. This is a more detailed assessment than the WetMecs classification (Wheeler & Shaw (2000) which combines landscape situation (e.g. floodplain or valley head), water supply mechanism, topography, base status (pH) and fertility.

### 3.4.2. Scale of assessment

Davidsson et al. (2000) suggest that when planning a monitoring program, the appropriate selection of the scales to be studied (e.g. landscape, catchment, sub-catchment, peatland, sites within a peatland) depends on the objectives of the study. Holl & Cairns (2002) suggest that ideally, all restoration projects should be monitored at large spatial scales, for long time periods, and high levels of detail. Michener & Houhoulis (1997) suggest that given typical personnel and budget constraints, a trade-off usually occurs between:

1. Frequently sampling a number of parameters at a few points;
2. Infrequently sampling many parameters at relatively few locations; and
3. Infrequently sampling a few parameters at many locations.

Results from the survey (Appendix 1; Q3) showed that restoration project sites may cover a number of peatland types from upland blanket bogs to lowland fens. Clearly, the restoration and monitoring objectives must be specified for each peatland type.

For example, at the large scale the results of the National Peatland Resource Inventory (NPRI) evaluation of lowland peatlands across Britain using satellite imagery identified that the extent of lowland peatland soil deposits was much greater than the remaining extent lowland peatland habitats (Lindsay & Ross, 1993). The repetition of monitoring at this scale can be applied to show dramatic changes that take place over longer time periods. In a similar way, the increase in the extent of heather burning on English uplands was assessed at the moorland scale by the interpretation of aerial photography using Geographical Information Systems (Clutterbruck, 2004). At the small scale, changes in plant species composition can be detected by very fine-scaled monitoring. These need not be complex, and can use simple assessments such as plant 'presence/absence' or a basic abundance scale. The key point is that these data are collected within small sample areas (perhaps 10cm x 10cm cells) within a fixed area that can be accurately relocated. These techniques have been successfully employed to assess changes in dominant plant species under different *Molinia* management techniques (Ross et al., 2003), the recovery of post-burn *Sphagnum* on a lowland raised bog (Lindsay, 1977) and monitoring blanket bog translocation (PAA, 2006a). Combining scales of data into modelling frameworks is also an option, allowing more detailed site specific monitoring information to be extrapolated across wider areas. This approach has been used by Acreman et al. (2009)

to extrapolate wetland ecohydrological datasets from across Great Britain to successfully create a 'baseline' from which climate change effects may be predicted.

The scale selected for monitoring must be appropriate for the population/community or process being monitored (Holl & Cairns, 1995). The objectives also influence where the sampling plots might be located in the peatland (e.g. along transects, as nested plots, in a regular or random design). For surface-flow peatlands, all water inlets and outlets have to be included in a monitoring program in order to set up a water and mass balance. For subsurface-flow peatlands recharge and discharge areas could be distinguished. These guidelines generally deal with a scale of the size of a given peatland and scales within the peatland.

### 3.4.3. Starting point

Monitoring of restored peatlands should ideally start two or three years before the work commences to account for temporal seasonal effects on certain parameters, however in many cases this is not practical and a single pre-restoration 'baseline' evaluation may be all that is available or possible. Even when a strict baseline dataset has not been gathered, if for example some restoration works have already started on a site, collecting data on change over time can still provide very useful and important information on which direction change is occurring and if it is progressing toward the target set for the site. The assessment of the starting situation is necessary in order to evaluate the success of the realised measures at a later date. When measures to restore habitats are being taken, selection of a reference peatland can facilitate the interpretation of biological development (Davidsson et al. 2000) and where baseline data are limited or absent, a reference site can be useful for all forms of restoration monitoring as this enables some assessment of time-related changes that are independent of the restoration technique (J. Carroll, pers. comm.).

### 3.4.4. Intensity and duration

Intensity and duration of monitoring have to be adapted to the objectives of the peatland restoration, and to the amount of funding available as well as to the specific technique. The 'what' and 'why' you are monitoring will determine the periodicity of monitoring (Appendix 2). Intensity can change during the monitoring period. Davidsson et al. (2000) suggest that it is beneficial to start on a high intensity level and reduce the monitoring program when the main patterns of water flow and biogeochemical processes are known. However, parameters such as hydrology and physicochemistry undergo heavy fluctuations within and between years (for example, Proctor, 1992, 2005), and therefore it is important that monitoring programs for these parameters proceed during longer periods (at least several years) to identify trends in peatland performance (Davidsson et al. 2000). However, some data analysis packages such as 'Temporal Analyst' for ArcGIS (DHI Software) can reduce the effect of seasonality on time-related datasets and also bridge gaps where data are missing.

Quinty & Rochefort (2003) state that it is paramount to consider the right timeframe when setting specific objectives and evaluating the success of restoration. Peatland restoration is a process that typically takes several years and often decades to achieve. D'Avanzo (in Kusler & Kentula, 1990) stresses the importance of long term evaluation during wetland restoration, suggesting the 1 to 2 years is too short and that 10 to 20 years is desirable. In particular, D'Avanzo indicates that restoring peatland function such as stores of organic matter, can take 15 to 30 years or longer. For Canadian

cutover peatlands, Quinty & Rochefort (2003) state that establishing a full plant carpet dominated by peatland species including *Sphagnum* and stabilizing the water table near the surface can be achieved in about five years. For these sites, they suggested they be monitored only from the second year after restoration work. Its development toward a functionally restored peat bog should be determined after plant establishment and hydrological conditions have been monitored two or three times (Quinty & Rochefort, 2003). However, the timing or start date of monitoring could start immediately following restoration and will depend on the type of peatland and type of restoration. Holl & Cairns (2002) and Cairns (1991) suggest that ideally monitoring should be continued until the ecosystem is self-regulating for some particular period of time. Self-regulating means that the structural and functional attributes persist in the absence of whatever subsidies may have been necessary during the initial restoration efforts (Holl & Cairns, 2002).

Several studies have monitored peatland vegetation restoration on blanket bogs and provide useful information on timing/duration of monitoring. On severely degraded bare peat area at Holme Moss in the Peak District (Anderson et al., 1997), the addition of heather seed along with a grass 'nurse' crop plus lime and fertiliser showed the importance of monitoring for the first two to three years after restoration is applied (along with a pre-restoration baseline). This enabled the success of the establishment of the all important 'nurse' crop to be monitored along with the germination and establishment success of the heather. The approach would allow any failure in establishment to be addressed quickly by re-applying all/part of the treatment as necessary. Once the critical first few years are known to be successful, monitoring could be reduced to a more infrequent timescale (every other year or perhaps longer as the restoration progressed). Similarly, a study monitoring the recovery of blanket bog vegetation at Fylingdales in the North York Moors, after fire (Manners, 2009) indicated there was rapid change in the three years after the fire suggesting the monitoring of any post-fire restoration would be annual in this period at least, but could be less frequent after. A study assessing the effects of a reduction of sheep grazing levels on blanket bog vegetation at Kinder Scout (Peak District) monitored vegetation change annually over 10 years and results were still detecting useful and important (Anderson et al., 1997). In cases of severe over-grazing the response of dwarf shrub species to a reduction in grazing pressure may also be delayed by one or two seasons as the plants recover, as was observed on Caldbeck Common in the Lake District (PAA, 2006b). All these studies show the need to consider the anticipated rate of response to the restoration technique to inform the frequency and length of the monitoring programme.

#### 3.4.5. Costs and expertise

The average annual cost of monitoring for 10 of the 29 projects evaluated in this survey was £18720 ranging from £200 per year to £70000 per year (Appendix 1; Q15a). Details of costs for specific monitoring techniques are provided in Appendix 1; Q16a. Costs can be minimised by recruiting volunteers to conduct monitoring protocols when they do not require a high level of experience and training but they may require supervision at some point (Appendix 2) such as breeding bird surveys. Other monitoring techniques such as hydrological monitoring and remote sensing can be expensive. In many cases, collaboration with peatland academic research groups at a number of UK universities may reduce the funding required for monitoring. This advice cannot be overstressed enough as the collection and evaluation of data from restoration projects provided from experienced research groups will ultimately provide evidence to support monitoring and restoration techniques used for the success of peatland restoration.

### 3.4.6. Documentation

A well prepared recording sheet which draws attention towards the previously selected indicators helps to standardise the recordings of every field visit. Examples for the design of recording sheets are given by Mitchley et al. (2000), Quilty & Rochefort (2003). Peatland monitoring programs could be coordinated by regional or local partnerships or groups in cooperation with experts from the different investigation fields. A digital database structure accompanies this report that could be used and modified by a consortium of peat restoration projects. If a monitoring program is carried out in different areas (regions, countries) the selection of parameters and the sampling methods could be coordinated in order to ensure the comparability of the data (Hellawall, 1991). Furthermore, among different working groups working in the same area, effective coordination can bring many advantages, e.g. data exchange. Both the integration and adaptation of existing monitoring programs and the development of new techniques for integrated monitoring can help to reduce costs and to improve data quality and information content (Brown & Rowell, 1997; Bricker & Ruggiero, 1998).

### 3.5. Assessment of restoration success

The interpretation of monitoring data against the criteria that are set, allows evaluation of whether the restoration objectives have been met. The goals of restoration will be fulfilled once the objectives are attained. However, the validity of this assumption is not guaranteed, since the objectives and criteria may prove to be inadequate. Ecological succession does not always show an expected trajectory. Statistical analysis of monitoring data is a means to assess the success of restoration. When determining whether or not a hypothesis has been supported by the monitoring data, the causes of variability (e.g. climate) and extent of variability (from replicated plots) in the data must also be recorded. This is particularly important when natural fluctuations (e.g. in water depth or population levels) are highly variable or even unknown.

The success of wetland creation projects in America has been evaluated in a broad way by D'Avanzo (in Kusler & Kentula, 1990). The assessment was based on six criteria that were chosen because they are typically measured in some way on wetland creation sites and because comparison across schemes is possible, as follows:

- Comparison of plant growth (for example, biomass or density) in artificial and natural wetlands after two or more growing seasons.
- Habitat requirements (e.g. upland *versus* wetland) of plants naturally invading/establishing in the created wetland site. The persistence and dominance of either planted or naturally invading obligate wetland plants was considered a good measure of success.
- Success of planted species.
- Comparison of animal species composition and biomass in the created and natural wetlands. The studies assessed concentrated on evaluating macroinvertebrate species diversity and total biomass between naturally occurring and artificially created wetlands using replicated sediment core samples.
- Chemical analysis of artificial wetland soils compared to natural wetlands.
- Evidence of geomorphic or hydrologic changes with time.

Using these six criteria, the author found that over 15 years the vegetation structure of the created wetland site became similar to the natural site, and one 15 year animal study showed similar results and several studies showed similar trends with soil chemistry. Therefore, although wetland systems appear to be able to be successfully created the habitat and function of the created wetland does not begin to work as a 'natural' system until a decade or more after creation. The assessment also indicated that the key factor in the failure of wetlands to establish was due to incorrect hydrological regime and that upland systems appeared more difficult to replicate in terms of hydrology than lowland sites.

Two strategies exist for conducting an evaluation of restoration success (SER, 2004): *direct comparison and trajectory analysis*. Socio-economic goals may be assessed by other techniques used in the social sciences. The evaluation of socio-economic goals is important to stakeholders and ultimately to policy-makers who decide whether or not to authorise and finance restoration projects.

### 3.5.1. Direct comparison

In direct comparison, selected parameters are measured in the reference and restoration sites. This could involve the determination of a range of parameters including both biotic and abiotic components. A suite of traits that collectively describe an ecosystem function fully yet succinctly would be preferable. However, the complexity of peatland ecosystems means that the ecological processes and functions occurring within two identical peatlands is unlikely to be the same. For this reason, a restored peatland at a project site should be compared to an average of a number of reference sites within the same climatic zone rather than a single reference site. It would be impossible to measure all of the known ecological variables within a specific time frame in order to determine the success of restoration. Therefore, the parameters chosen to indicate restoration success will depend to an extent on value judgement.

### 3.5.2. Trajectory analysis

This is a strategy for interpreting large sets of comparative data. Data collected periodically at the restoration site are plotted to establish trends. Trends that lead towards the reference condition confirm that the restoration is following its intended trajectory. Under different views, the results of evaluation may be different. For example, the restoration may appear to have been successful in ecological terms, but not in aesthetic terms (Smale *et al.*, 2001). However, this depends on the goals and objectives of the restoration set at the start of the project.

Trends in monitoring data can be assessed by a variety of techniques in statistical software such as Minitab, Sigma Plot and GraphPad Prism. These techniques include time series plots, trend analysis, ARIMA modelling, simple regression analysis, and multiple regression analysis. The choice of method should be based upon whether the patterns are *static* (constant in time) or *dynamic* (changes in time), the nature of the trend and seasonal components. Stepwise regression analysis and Analysis of Covariance (ANCOVA) may be useful when attempting to identify the impact of varying climatic variables. Time series plots and trend analysis should be used first to gain an understanding of the data trends i.e. linear versus non-linear, constant versus dynamic. Parameters that can be modelled significantly with regression techniques are more likely to suggest a trajectory over time and therefore suggest progress towards success if that parameter is an indicator of success. Trend analysis is probably most suitable for assessing trends over time, whilst correlation and regression

techniques can be used to determine if known relationships between dependent and independent variables are following a trajectory over time. For example, increased *Sphagnum* productivity or peat methane emissions with rising water table,

### **3.6. Adaptive management decisions**

Once monitoring has been completed and an assessment made of the condition of the attributes, the JNCC suggests a feedback loop to site management or restoration and a review of the objectives. The monitoring assessment may trigger adjustments to site management or restoration practices, or possibly be used to direct more detailed investigation into the reasons for apparent problems. This relates to the assessment of the hypotheses and the development of new hypotheses based on the outcomes of the original hypothesis being tested. Where the reasons for an unfavourable assessment are unclear, or the appropriate management response is unknown, there may be a need for further, more detailed survey, monitoring or even experimental research activities (JNCC, 2004a).

Monitoring and adaptive management is used to evaluate and adjust maintenance and design remedial actions and should feedback on the restoration and monitoring objectives. Adaptive management considers changes in ecological patterns and processes, including biodiversity of the restoration project as it evolves or goes through successional stages. Adaptive assessment provides the means for continually reducing the levels of uncertainty by learning from system responses and using the new information to refine the design of the restoration plan (Ogden et al., 2003). Trends in the surrounding area as well as in control plots and the restoration site itself must be taken into account. One proactive methodology is incorporation of experimentation into the plan when possible, such as experimental plots within a restoration site with different controls, replication, different treatments etc., to determine if specific restoration efforts are meeting the desired goals. This provides the advantage that different restoration techniques can be assessed and thus the reason for failure or success can be evaluated. Disadvantages may be that whilst the area of peat restored over time will be reduced within the plot, this strategy may also require more time and funding. This could be overcome by keeping experimental plot sizes small relative to the total restoration area. However, Ogden et al. (2003) state that adaptive assessment is valuable in that it treats all responses, expected or not, as learning opportunities. An unexpected response does not represent a failure for the restoration plan if it can be used to improve our understanding of a complex system so that corrective actions can be made. Implementation of the restoration plan is a “test” of the accuracy of the working hypothesis use to organize the conceptual models and to support the performance measures. Adjustments in the models and measures based on information coming from the monitoring and assessment, and from supporting research and simulation modeling, is the best route to increased levels of certainty as future iterations of the restoration plan are implemented. Busch & Trexler (2003) and Ogden et al. (2003) provide a number of detailed case studies on monitoring design and adaptive management.

## 4. MONITORING TECHNIQUES

### 4.1. Choosing monitoring techniques

Monitoring is performed by collecting data on measurable elements at different periods of time to evaluate the development of a restoration site (Quinty & Rochefort, 2003). Although objectives of peatland restoration are defined mainly in terms of hydrology, water chemistry and vegetation in the short term, much monitoring has focused on vegetation. This is probably because the plant communities which develop reflect the general conditions of a site because plants and the communities they form, occupy distinct ranges of environmental conditions, such as soil hydrology, or nutrient availability, and can be used to indicate these conditions. Nonetheless, collecting data on hydrology, greenhouse gas fluxes, and peat and water chemistry can be very useful for the interpretation of vegetation data as well as informing about the respective parameter. Environmental parameters can show a response to restoration measures more rapidly than might be detected in a plant community, so an indication that the correct conditions to support the target habitat are being met may be achieved sooner by monitoring selected environmental parameters alongside vegetation.

Monitoring these environmental parameters can also be very important where their current levels may hinder the restoration of the target vegetation/habitat type, as ongoing measures to mitigate these conditions may be required. For example, the application of lime and fertilizer has been used to aid re-establishment of vegetation on severely eroded bare peat areas where highly acidic peats were exposed, but the effects of the treatment declined over time (Anderson et al., 1997). Therefore repeat applications in the first year of restoration may be beneficial, and is being undertaken on some current bare peat restoration projects (S. Ross, pers. comm.).

Monitoring of a wide variety of attributes or parameters may be more useful than extensive monitoring of vegetation or hydrology alone, particularly when habitat restoration is a central objective. Gorham and Rochefort (2003) suggest that monitoring of all ecologically relevant properties be continued long after restoration to follow the development of the system over time, especially when the restoration approach is novel. For example, *Sphagnum* may not be recovering as predicted in a re-wetted blanket bog. Monitoring of nutrients may identify eutrophication as a cause of reduced growth, and thus nutrient pollution will also need to be addressed. Such a trajectory analysis should include surveys of vegetation type and composition, hydrology, biogeochemical cycles, water and peat chemistry as well as microbiological analysis (Chapin et al., 1992). However, it has been suggested that measuring everything is simply not realistic, and it is not easy to make a case for time and expense of long-term monitoring (Appendix 1; Q19).

Species of living organisms are the units of biodiversity and can represent the objectives of restoration management or provide valuable indicators of complex environmental conditions, ecosystem functioning and/or habitat status (Schumann & Joosten, 2008). Restoring for biodiversity rather than, for example, carbon sequestration would restore ecosystem integrity that could support other conservation objectives such as achieving favourable condition for SSSIs *sensu* Natural England (Appendix 2). Plant species reflect habitat changes in a detailed way by their presence, disappearance or absence (Schumann & Joosten, 2008) and therefore also represent change in the peat environment. However, it has been suggested that not all peat biogeochemical processes and functions can be restored via biodiversity restoration. Nonetheless, important regional overviews for the indicator value of plant species are provided by Ellenberg et al. (1991) and Tiner (1991, 1999). Also, the monitoring of selected animal species (e.g. dragonflies, butterflies, and amphibians) may deliver insight into complex habitat conditions. Monitoring strategies are described by Stoneman & Brooks (1997), Bardsley et al. (2001), Budd (1991), Clarkson et al. (2004), Dryden (1997) and Treweek et al. (1997). Vives (1996) and Crofts & Jefferson (1999) offer an extensive monitoring bibliography.



The Common Standards Monitoring guidelines for upland habitats and lowland wetlands link broad habitats with NVC classification and provide targets for assessing the success of restoration that may be suitable for some peatland habitats and restoration techniques. An excellent guide to monitoring techniques for biodiversity assessments in conservation is given by Sutherland (1996 & 2000). We also recommend the monitoring techniques used by the ECN at Moorhouse NNR <http://www.ecn.ac.uk/aboutecn/index.asp>. A list of the minimum monitoring required to deliver useful information is provided in Table 3. The guidelines which accompany this technical report provide tables for selecting the appropriate methods for specific restoration objectives (Bonnett et al., 2009).

**Table 3** Priority list of minimum surveying required to monitor specific parameters (see Appendix 1; Q10).

Parameters	Method	Timing	Staff
Peat physical integrity	Peat pins, fixed grid monitoring, sediment transport, water colour analysis (DOC)	Seasonally or monthly	Trained staff and specialists
Vegetation succession	Vegetation quadrats % cover and composition	1 year or 2 yearly, July	Trained volunteers
Breeding birds	Breeding Bird Survey (BBS), Common Breeding Birds (CBB)	1 year or 2 yearly, spring	Trained volunteers
Invertebrates	Pitfall traps, BWMP	Annually	Trained staff
Microorganisms	Microscopy, biomass, enzymes	Seasonally or monthly	Specialists
Hydrology	Dipwells, piezometers	Monthly or weekly	Trained staff
Soil and water chemistry	Ion chromatography, pH analysis	Seasonally or monthly	Specialists
Carbon flux	Primary production, of <i>Sphagnum</i> , gas exchange collars and DOC analysis of pore water	Seasonally or monthly	Specialists

## 4.2. Peat physical integrity

### 4.2.1. Introduction

Measurements of peat integrity include indications of the condition of the peat mass, and of the peat itself. Parameters indicating the condition of the peat mass include the degree of erosion present, and the degree to which the peat mass is dissected by grips. Parameters used to indicate the condition of the peat material include bulk density, humification, mineral content, compaction (drumminess), and hydrophobicity.

### 4.2.2. Measuring change in peat surfaces and peat depth

Erosion pins are used to measure the surface lowering of peats due to erosion, and comprise narrow metal rods driven through the peat deposit and anchored firmly into the underlying substrate. The rate of surface lowering is usually measured in mm or cm per year. In some experiments the metal pins have been replaced by cheaper plastic or bamboo cane alternatives allowing more sample points to be installed on a site (Phillips et al., 1981). However, these less expensive methods may yield inaccurate results as the pins are prone to frost-heave unless well anchored within the underlying structure (Tallis & Yalden, 1983).

Phillips et al. (1981) also summarise the published and unpublished rates of surface lowering as measured by erosion pins in Table 4.9 of their report, including blanket bog sites in North York Moors (Imeson 1974), Wales (Bridges & Harding, 1971; Slaymaker, 1972), Yorkshire Dales (Harvey, 1974) and the Peak District (Evans, 1977). Data from their own study is presented in Table 4.10. More recently the 'erosion pin' technique has been used for a study of peatland restoration after forestry plantation felling at Plynlimon, Mid-Wales (Stott, 2005) and in creating a sediment budget for a moorland site at Upper Teesdale, Northern England (Evans & Warburton, 2005).

The general layout of peat pins is in a transect or grid form, the distance between each pin varying but typically 30cm to 50cm apart. Frequency of measurement ranges from every 3 months to once a year. The peat pin layout typically covers a range of topographic/erosion situations in a single study to enable the surface lowering on different features (e.g. bare peat areas, felled plantation sites, eroding gullies, stream sides) to be assessed. Areas where erosion was likely to be reduced or less (e.g. vegetated areas) are usually included for comparison. Peat pins can also be used to assess rates and locations of the redeposition of mobile peat over the surface. Evans et al. (2006) measured rates of erosion in blanket bog using 60 cm long 3 mm diameter stainless steel pins inserted normal to the peat surface in groups of 11-14 pins in a cross formation to account for vertical and lateral variability in erosion rates over gully walls. Pins were measured monthly.

A modified version of the peat pin based on the standard 'point quadrat' was developed to assess peat erosion and redeposition (Tallis & Yalden, 1983). Two wooden stakes were anchored into the mineral substrate 1.5 m apart across the area to be monitored. A removable wooden cross-bar, perforated by 25 holes each 5 cm apart, was placed between the stakes and the distance between the wooden cross-bar and the peat surface was measured by lowering a fine metal pin, using a rubber washer to prevent slipping. A profile of the peat surface can be drawn and the change over time along the profile measured. A diagram of the apparatus is presented in Fig. 5.1 of Tallis & Yalden (1983, p. 49). In this study, the measurements were undertaken at a range of different locations on Holme Moss in the Peak District, with measurements taken every month over 1 to 2 years.

Peat erosion has also been monitored in the same study using fixed 0.75 m x 0.75 m quadrat placed along an erosion 'hagg' created by sheep habitually sheltering in that area, also on Holme Moss. The area was split into 15 x 15 squares within which to record the turf line, and the turf lines mapped four times over 22 months. This method successfully detected on average a 2 cm (and up to 5 cm) recession of the turf line using a simple method that requires no specialist training. An indirect and simple method to measure peat erosion is to use screens of varying mesh sizes to trap sediments being mobilised on the peatland (see pg. 103 on POC flux). POC flux has been determined as the major component of fluvial carbon loss from eroding mires (Evans et al. 2006).

Peat depth can be measured relatively easily using a narrow rod that can be pushed into the peat at regular intervals across a site, and the depth to which the rod sinks reflects the local peat depth. On shallow peats a single narrow metal rod can be quickly and easily used. On deeper peats a series of rods that screw together can enable measurement of relatively deep peats allowing the form of the peat deposit to be assessed and this can be particularly useful in topographically constrained peatland such as basin mires (e.g. Ross, 1999). However, measuring very deep peats can be problematic as removing rods sunk to depth can be difficult and some rods bend as you push them into peat, giving false depths. In many cases, however, there is not a need to know the precise depth of deep peat deposits so getting to the very base of the peat deposit is not always necessary for restoration monitoring but it can be useful. Accurate peat depth measurements can form the basis of long-term estimates of peat loss and subsidence, or long-term rates of accumulation. In many cases, restoration monitoring requires measurement of more subtle changes in peat depth, such as peat erosion and re-deposition (see above), peat shrinkage following drying and peat swelling/expansion as a result of re-wetting. Monitoring of peat shrinkage and swelling is important because they affect peat subsidence and swelling can indicate that the peat is able to hold more water within its structure and therefore has a greater water storage capacity. Oleszczuk & Brandyk (2008) investigated peat volume changes in moss peat layers during drying-wetting cycles using the 'sarin resin' method. Warburton et al. (2004) suggest several important hydrological controls for surficial mass movements in peat but the prospect of predicting the location and timing of such events is still a long way off.

Commonly, the surface levels of peat can change between winter and summer – a phenomenon known as *Mooratmung* or 'bog-breathing'. Peat swelling can be relatively easily assessed using a method that measures the movement of a metal plate buried just below the peat surface relative to a datum post fixed into the underlying mineral substrate (Stoneman & Brooks, 1997). The top of the fixed datum stays the same while the metal plate in the peat surface is expected to rise as the peat re-wets and swells. The height difference between the fixed datum and the metal plate in the surface should reduce as the peat swells and the surface rises (Stoneman & Brooks, 1997). Peat anchors can be used to detect changes in the fall and rise of the bog surface or to detect peat accumulation over many years. Wood and metal can be used, but wood is suitable only for shallow peat and is more easily dislodged by frost and animals. Metal conduit pipe is generally suitable (Fig. 4).

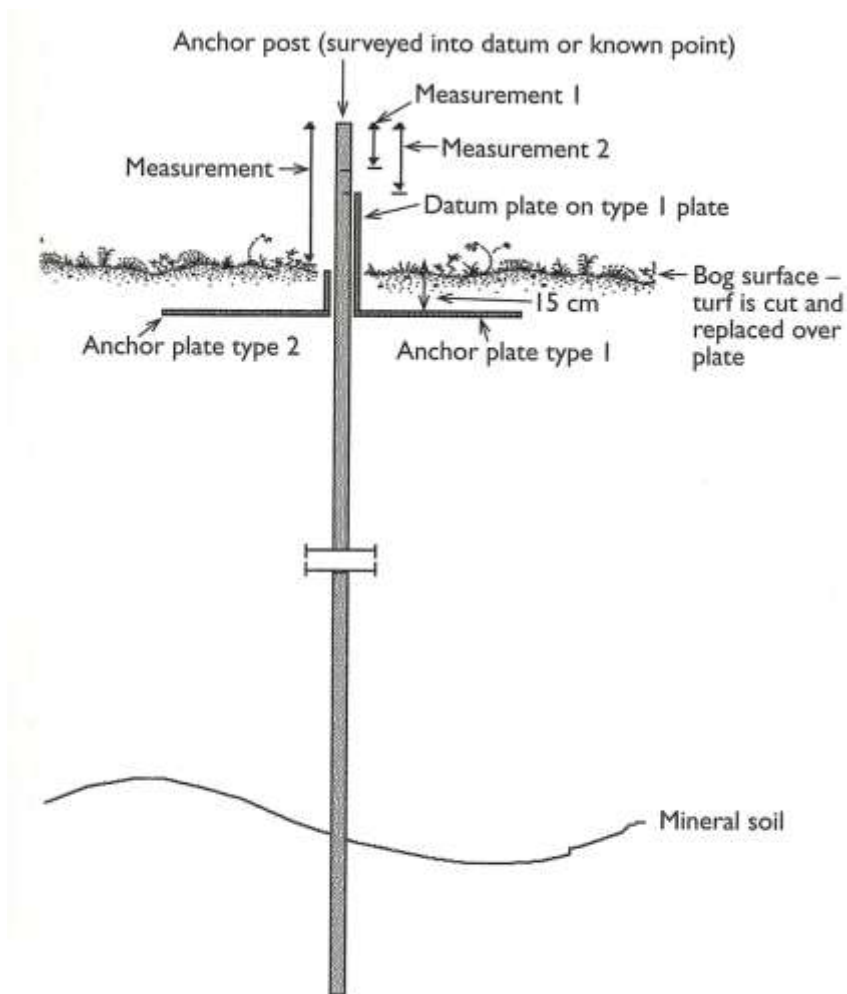

Rise and fall of bog is measured in two ways:-

1. By measuring from the top of the anchor post to the top of the anchor plate post
2. By making a saw cut in the anchor post at the top of the anchor plate

**Figure 4** Design details of the anchor posts used to measure the rise and fall of a bog (adapted from a design by J. Davis, CCW by and in Stoneman & Brooks, 1997).

During re-wetting the potential for ‘bog bursts’ should also be considered. Bog bursts occur when large amounts of peat become very liquid and move, sometimes rapidly. On lowland raised bogs this is often at the edges of the bog where the peat integrity has been compromised by peat extraction, while on blanket bog it occurs when surface layers slip down the hillside. The IPCC ([www.ipcc.ie/infobogburst.html](http://www.ipcc.ie/infobogburst.html)) suggest that bog bursts can occur on slopes of 4 degrees or greater, but that slopes of only 2 degrees have been affected on occasions. Triggers for bog bursts include heavy rainfall, especially after prolonged drought when the plant root mat has diminished and the peat structure appears more vulnerable.

LIDAR is becoming an increasingly used remote sensing technique for assessing peatland habitats in terms of description, identifying areas to target restoration measures and for subsequent monitoring. It is an airborne mapping technique that uses a laser scanner to measure the distance between the laser sensor and the ground, resulting in a surface map. However the increasing

portability of LIDAR scanning units is making ground-based surveys more feasible in many situations and this approach has already been used in field surveys (e.g. Loudermilk et al., 2007). The technique is relatively expensive and requires technical input and data processing but there are several benefits to using this approach. It can produce a detailed elevation map of the peatland surface over large areas at a high resolution (in some cases, 15 – 35 cm) and with correct interpretation the depths of grips, peat haggings and streams, catchment areas of grips and streams and other information can be derived, on which both restoration and monitoring strategies can be based. Repeat flights can help measure rates of erosion, infilling of grips, and down-cutting of streams. LIDAR can take surface measurements through some vegetation types, such as heather cover or an open tree canopy, allowing the underlying surface topography to be mapped. It is also not affected by weather or seasonal changes in vegetation. The technique does not penetrate open water so cannot map the basin shape of a lake, for example, but does enable the area of the open water to be assessed.

Bennie & Anderson (2008) report the promising potential for the large-scale monitoring and mapping of surface pattern as an indicator of hydrological and ecological status in lowland raised bogs. Milton et al. (2005) suggest that LIDAR may prove to be a highly effective method of surveying the surface topography of degraded bogs, since this technique has sufficient vertical resolution to detect even subtle changes in relief. More complicated automatic techniques are probably not necessary for detecting damage that is sufficient to disrupt the overall site hydrology of raised bogs. These signs of disturbance can also be detected from the air, either by simple manual interpretation techniques using either air photographs or IKONOS imagery. Remote sensing provides a simple means of identifying the extent of many lowland raised bogs, as the contrast between the area of bog and the surrounding agricultural land is often very high, especially in the near infra-red region. Many satellite sensors include a spectral band in the near infra-red, so, depending upon the spatial resolution required, it would be possible to map the extent of lowland peat bogs using data from IKONOS, SPOT HRV, Landsat ETM+ and many other systems (Milton et al., 2005).

Good quality aerial photography is widely available for peatland areas and can be a useful monitoring tool for large and inaccessible areas such as blanket peat, or for placing several smaller sites in a regional or national context. Features such as grips, erosion haggings and gullies, along with areas of bare peat, open water and different vegetation types can be mapped and evaluated using GIS and photographs from different time periods (including old photographs) can be compared over time. Johnson (1997) suggests aerial photographs should be flown every two years for strategic monitoring of peatland restoration on a selection of representative sites. However, there are now several commercial providers of aerial photography which may mean that special commissioning of aerial photography flights is no longer necessary and 'off the shelf' data are available. Aerial photograph interpretation does have some restrictions, for example shadows cast by cloud cover, steep slopes and the angle of the sun on tall vegetation (or other features) can change the appearance of the photograph, as can the season that the photography was flown. The distortion of aerial photography can make overlaying these data with Ordnance Survey or LIDAR imagery difficult without suitable orthorectification within the GIS system so the scale is uniform across the image and there is no distortion. The interpretation of aerial photography requires experience particularly in identifying differences in superficially similar vegetation types which is often impossible even by experienced interpreters. There are also issues with availability – the data available may have been derived from flights flown over several years, owing to weather conditions preventing a single year's coherent data. Light conditions and time of year also result in highly variable colour representation, which can confuse interpretation. Aerial photography typically miss a proportion of some peatland features, simply because they aren't visible on the photos e.g. overgrown grips, or lead to misinterpretation e.g. sub-soil drainage or rig and furrow as grips.

### 4.2.3. Physical characteristics of peat

#### 4.2.3.1. Bulk density

Peat bulk density (the peat oven-dry mass per unit volume) is an important parameter for estimating the amount of C stored in peat as well as influencing the storage and flow of water, gases and heat, the availability of nutrients, and providing habitats for organisms.

Bulk density is determined by collecting uncompacted peat cores of known volume from specific depths of peat. Hammer-type core samplers with thin-walled metal sleeves that slide into a coring tube are available commercially for soil analysis. However, for peat analysis great care must be taken as compaction of the peat can occur easily and therefore this method is not recommended. The length of the core will depend on the depth to be sampled and should be considered carefully as bulk density increases with depth (see Elliot et al. 1998). Alternatively, large peat monoliths can be removed using a spade from which smaller units can be removed using a knife. The volume of peat can be determined using a ruler or by Archimedes principle in which the peat is sealed in watertight film and placed in a beaker of known volume filled to the top with water. The water displaced is collected in a container and the volume determined with a measuring cylinder as ml (equivalent to cm<sup>3</sup>).

Givelet et al. (2004) state that the low density and the unsaturated environment of the topmost layers of a peat bog make the collection of good quality peat cores challenging. It is difficult to cut these layers as they are easily trampled and compressed. They suggest that the topmost layers of peat can be collected using a 10 x 10 x 100 cm Wardenaar peat profile cutter (Wardenaar, 1987) which is commercially available. Givelet et al. (2004) used a modified 1 m Wardenaar corer with XY dimensions 15 cm x 15 cm, which was home-made using a Ti-Al-Mn alloy and includes a serrated cutting edge; this new cutting edge cuts more easily through dwarf shrubs (e.g. Ericaceous shrubs) and Eriophorum root fibres. This feature, combined with the larger cross sectional area means that any given slice undergoes less compression in the Z (vertical) dimension. Moreover, the enlargement of the XY dimensions to 15 cm of the new Wardenaar corer compared to the older version (10 cm) provides enough peat sample material to conduct a wide range of analyses and still to be able to preserve part of the material as an archive for futures work, even using thin slices (i.e. 1 cm). During extraction, some compression of the peat core is unavoidable. However, the compression can be measured, using the bog surface as a reference. After extraction, the Wardenaar corer is laid horizontally on the bog surface, on a large sheet of plastic; the top half of the Wardenaar corer is removed, exposing the peat monolith. This core is described visually in the field (length, colour, texture, plant remains, moisture, special layers) and photographed. The core is inspected for modern plants of the bog surface which may have “contaminated” the outside of the core; these are carefully removed using a small knife. The core is wrapped in polyethylene cling film, with the film pressed down around the sides of the core and ends using a plastic spatula. The core should be stored in a tough plastic container in order to prevent compression. The volume of the peat core is determined from the volume of the corer, and the depth of the peat which can be sub-divided into depth bands. The core is then oven-dried at 70 - 105 °C until dry (usually 2 or 3 days) meaning no change in mass, and then weighed:

$$\text{Bulk density (g cm}^{-3}\text{)} = \text{oven dried weight of core (g)} / \text{volume of core (cm}^{-3}\text{)}$$

This method can be laborious and time consuming, and therefore a simple and fast method has been used involving estimation of the volumetric water content by dielectric constant techniques (time domain reflectrometry [TDR], amplitude domain reflectrometry [ADR]) (Wijaya et al., 2003). The ADR or Theta probe is relatively cheap and the output is direct current voltage, which can be measured by

commercial multichannel logger to monitor change in water content (Gaskin & Miller, 1996). Dry bulk density can be calculated as a function of the volumetric water content measured by a probe combined with either wet bulk density (1) or gravimetric water content (2) (Wijaya et al., 2003):

$$(1) \text{ Dry bulk density (g cm}^{-3}\text{)} = \text{wet bulk density (g cm}^{-3}\text{)} - [V_{\text{ADR}} \times \text{density of water}]$$

$$(2) \text{ Dry bulk density (g cm}^{-3}\text{)} = (V_{\text{ADR}} / \text{gravimetric H}_2\text{O (g H}_2\text{O g dry peat)}) \times \text{density of water}$$

where density of water = 1 g per ml, and  $V_{\text{ADR}}$  is the volumetric water content measured using an ADR probe ( $\text{cm}^3 \text{ cm}^{-3}$  or ml/ml). For the first calculation, the volume of peat collected must be known in order to calculate the wet bulk density. Thus this method suffers from the peat compression limitations above. For the second calculation the sample must be oven dried to constant weight although the peat volume does not need to be known. This method therefore may be more time consuming although time may be saved in the field. Wijaya et al. (2003) showed that the estimation of dry bulk density with wet bulk density was better than that with gravimetric water content. They suggested that the accuracy of the probe is a critical factor in estimating dry bulk density.

Ground penetrating radar can also be used to determine the density of peat and the Environment Agency regularly fly in lowland areas although at different times of the year. Also, the height from a bridge or ground anchors can be used as reference points to calibrate the elevation data collected. However, caution was stressed as GPS and Ordnance Survey can conflict and be 5-10cm out and the height of raised mires can vary up to foot in a year depending on water input.

#### 4.2.3.2. Humification

Peat humification is a measure of the decomposition and structure of the peat and higher degrees of humification indicate a more well-decomposed peat. Humification and peat decomposition are useful indicators of the preservation of the peat (low humification indicating good preservation) and the likely hydrological conductivity of the peat body (low humification indicating high hydrological conductivity).

Although sophisticated techniques exist to determine the chemical structure of humic compounds, such as gas chromatography mass spectrometry (GCMS), pyrolysis mass spectrometry (PyMS), and nuclear magnetic resonance (NMR), most often they are fractionated with a simple scheme based upon their solubility at different pHs (Stevenson 1986; Bridgham & Lamberti, 2009). A pyrophosphate extraction of polyphenolic humic substances is also used (Bridgham et al. 1998; Bridgham & Lamberti, 2009).

Peat is commonly characterized by its degree of physical decomposition, either through its fiber content or with the qualitative von Post index (Clymo 1983). Organic soils (Histosols) are classified into three groups based on fibre content: fibrists, hemists and saprists (Mitsch and Gosselink, 2000; Richardson and Vepraskas, 2001) that depend on the degree of decomposition. The degree of humification or breakdown can be determined by the Von Post scale as a field method (Von Post and Granlund in 1926; Bridgham & Lamberti, 2009). According to the von Post method, peats are ranked on a scale from H1 to H10 relative to their degree of humification (Table 4). Within the organic soil horizon are the fibrists (little decomposition; H1-H3), hemists (intermediate decomposition; H4-H6) and saprists (high decomposition; H7-H10).

**Table 4** The von Post Scale of Peat Decomposition (after Hodgson, 1997)

Scale	Peat type	Peat Characteristics
H1	Fibrists	Completely undecomposed peat; only clear water can be squeezed from peat
H2		Almost undecomposed; mud free peat; water squeezed from peat is almost clear and colorless
H3		Very little decomposition; very slightly muddy peat; water squeezed from peat is muddy; no peat passes through fingers when squeezed; residue retains structure of peat
H4	Hemists	Poorly decomposed; somewhat muddy peat; water squeezed from peat is muddy; residue is muddy but it shows structure of peat
H5		Somewhat decomposed; muddy; growth structure discernible but indistinct; when squeezed some peat passes through fingers but most muddy water passes through fingers; compressed residue is muddy
H6		Somewhat decomposed; muddy; growth structure indistinct; less than one-third of peat passes through fingers when squeezed; residue very muddy
H7	Saprists	Well decomposed; very muddy, growth structure indistinct; about one-half of peat passes through fingers when squeezed; exuded liquid has a "pudding-like" consistency
H8		Well decomposed; growth structure very indistinct; about two-thirds of peat passes through fingers when squeezed; residue consists mainly of roots and resistant fibers
H9		Almost completely decomposed; peat is mud-like; almost no growth structure can be seen; almost all of peat passes through the fingers when squeezed
H10		Completely decomposed; no discernible growth structure; entire peat mass passes through fingers when squeezed

The von Post scale is a rapid field assessment technique. In this technique a sample of wet peat is squeezed through the closed hand and the colour of the liquid that is expressed through the fingers is noted, along with the proportion of the peat sample that is extruded and the nature of the peat/plant residues that remain in the hand. The scale is provided below (Table 4), and is a commonly used field technique to describe the nature of the peat, typically to characterise or compare between sample sites rather than monitor change over time (e.g. Holden & Burt, 2003; PAA, 2003). In terms of monitoring, the scale could be used as a coarse but rapid field assessment for the long-term monitoring of peat decomposition over time as Malterer et al. (1992) found it to be a relatively reliable indicator of the degree of peat decomposition. In degraded situations, von Post scale scores can rise relatively rapidly over a few years. This scale can also be used to characterise peat at different depths, since degree of decomposition usually changes over depth which may inform monitoring conclusions about hydrology etc. However, it is not as accurate as empirical techniques due to personal bias and the water content, and does not permit statistical analysis.

E4:E6 ratio is the ratio of humic acid (E4) and fulvic acid (E6), and is commonly used to indicate the rate of humification in the peat and represent changes in the type of organic matter being mobilised (Worrall *et al.*, 2002). E4:E6 ratio is determined by filtering samples through 0.45 µm GF/A filter paper and measuring the absorbance at 465 nm (E4) and 665 nm (E6) on a UV-VIS spectrometer (i.e. Jonczyk et al., 2009; Chen et al., 1977). Percent transmission is also commonly used as a proxy for peat humification and relative biochemical composition (Blackford & Chambers, 1993). The degree of peat humification can be determined using a spectrophotometer to measure transmission of light at 540 nm through a solution containing a mechanically homogenised peat sample digested in NaOH



solution. Well humified samples have more humic acid and, therefore, lower transmission. Caseldine et al (2000) report that luminescence excitation and emission wavelengths suggest that high molecular weight acids (humic acids) are altered by the NaOH extraction procedure to form lower molecular weight acids ('fulvic acids'), amino acids and polysaccharides. Percentage transmission is principally related to luminescence emission wavelength and thus to molecular weight of the compounds present. Luminescence emission shows much more sensitivity to peat composition and demonstrates that different plant species may be affected to different degrees by the NaOH extraction process (Caseldine et al., 2000). The findings broadly support the underlying principle of colorimetric determination of 'humification' whereby transmission levels decrease with increasing plant breakdown, but show that it is based on an inadequate understanding of the chemical processes occurring in peat decay and preparation procedures. Luminescence spectroscopy provides a technique for resolving these issues (Caseldine et al., 2000). McMorrow et al. (2004) report that this technique can be costly and time consuming. Klavins et al. (2008) suggest that humification describes the transformation of organic matter to humus, and therefore propose that the degree of humification should be expressed in terms of the quantity of formed humic substances as a fraction of the total amount of organic matter.

McMorrow et al. (2004) reports on progress towards using HyMap data at 3m spatial resolution and laboratory spectroradiometry to estimate physico-chemical properties of exposed peat, notably the degree of humification. The strong relationship of HyMap SWIR reflectance and derived indices with transmission provides a possible basis for estimating peat humification across extended areas, but the confounding effect of moisture content cannot be ignored. McMorrow et al. (2004) suggest that it is possible that higher moisture content were reinforcing the lower SWIR reflectance observed in poorly humified peats, especially as poorly humified peats in the study area were associated with wetter sites.

#### 4.2.4. Palaeoenvironmental techniques

Palaeoenvironmental techniques can be usefully deployed to establish the location and variation of more or less distinctive marker horizons in the peat e.g. recurrence surfaces, periods of desiccation/tree invasion and time synchronous layers such as atmospheric pollution fallout indicating the onset of the industrial revolution. In the specific context of restoration such monitoring techniques can help in the assessment of success against past peat conditions (e.g. macroremains and pollen) and future targets. Variations in the depth of time synchronous layers (e.g. determined by magnetic susceptibility or ecological markers) can provide an indication of the specific status of peat development pre-restoration. Palaeoecological records can provide valuable baseline data regarding the physical and biological characteristics of peatland prior to human impact, and can also serve to provide information on the natural variability of these characteristics over long periods of time (Taff et al. 2006; Kowalski and Wilcox 1999). Palaeoecology has been used to set remediation targets for peatland restoration (Lavoie *et al.* 2001, Girard *et al.* 2002) but it is an under-utilised tool (Gorham and Rochefort 2003). Palaeoecology can supply a detailed reconstruction for a site, and is a valuable tool for clearly establishing the goals of a restoration program (Lavoie *et al.* 2001). Information on some of these techniques that may be relevant to peat restoration can be found in Corfield et al. (1996), Charman (2002; Chapter 6 p. 155), and also Brown & Pasternack (2005) and particularly Taff et al. (2006).

#### 4.2.5. Conclusions

For peat integrity, quick and inexpensive assessment by erosion pins and the measurement of peat depth are recommended. However, where more detail and precision are required, POC flux and LIDAR may be more appropriate. LIDAR in particular appears promising for large-scale monitoring and mapping of surface pattern as an indicator of hydrological and ecological status in lowland raised bogs and therefore potentially in upland peatland ecosystems. Aerial photography is widely available and can also be a useful monitoring tool for large and inaccessible areas such as blanket bog. Interpretation of aerial photography and LIDAR do have restrictions including cloud cover, steep slopes and therefore experience is required for their interpretation.

Bulk density can be determined accurately if compression of the peat mass is avoided by collecting large peat monoliths or using a Wardenaar corer with a serrated cutting edge and large cutting diameter. These methods are recommended where the carbon budget is important. If time is an issue, bulk density can be assessed using a Theta probe for volumetric water content and gravimetric water content determinations by oven drying. However, if the C budget is an objective of restoration and monitoring then the coring technique should be used.

Humification can be measured simply and rapidly in the field using the von Post squeeze test, although this method may suffer from personal bias, water content and is not useful for statistical analysis. Therefore, it may be most appropriate for longer-term monitoring. Other techniques such as percent transmission and luminescence can be used for peat humification assessment which are more detailed and precise but require costly laboratory equipment and time. Work towards use of HyMap SWIR reflectance and derived indices with transmission provides a possible basis for estimating humification across extended areas, although currently confounding effects of moisture content cannot be ignored.

## 4.3. Biota

### 4.3.1. Vegetation

#### 4.3.1.1. Introduction

To monitor population changes it is not necessary (or usually possible) to have an absolute population estimate and a relative measure of abundance is sufficient (Sutherland, 1996). To determine if objectives are reached, the most important variables to consider are plant species, the proportion of the ground they cover (or similar 'dominance' or 'abundance' measure) and their development (or succession) through time. The recommended procedure describes vegetation at three levels: the site level, the permanent plot level and the ground level. These levels are complementary and allow a good assessment of the vegetation of an entire site (Quinty & Rochefort, 2003).

The vegetation might be monitored at different time periods after the implementation of restoration procedures to determine if the new plant cover develops toward a peat bog plant community. Quinty and Rochford (2003) recommend for cutover peatlands that vegetation monitoring is not carried out during the first growing season after restoration and that monitoring should start on the second year and be repeated after the third and the fifth growing seasons. However, there may be situations where monitoring within the first year of restoration is crucial such as re-seeding an area of upland bare blanket bog or to establish near baseline conditions in the absence of pre-restoration monitoring

At the NE workshop on monitoring peatland restoration, experts stressed that *Sphagnum* cover (e.g. *S. palustre*) was an important proxy for both water level and quality as well as peat surface conditions in upland and lowland peat forming systems and thus has been used as an indicator of restoration success (Appendix 2). Joosten & Couwenberg (2009) discuss the use of plant communities as proxies for greenhouse gas emissions (see section 4.9.4). Also, NVC characterization was deemed of importance for judging the restorability of lowland peat with M17 *Scirpus cespitosus* – *Eriophorum vaginatum* blanket mire being less challenging to restore but that areas of M25 *Molinia caerulea* – *Potentilla erecta* mire could complicate restoration efforts. Monitoring at Thorne & Hatfield moors (<http://www.thmcf.org/home.html>) has shown that the vegetation changes following hydrological restoration. These were initially recorded using indicator species followed by more detailed NVC survey and CSM.

A list of suggested positive and negative indicators for the restoration of raised mire is provided in Tables 5 and 6 (Wheeler and Shaw, 1995). The positive indicators in the restoration of raised mire for instance would include the major peat forming species (*Sphagnum papillosum*, *S. magellanicum*, *S. capillifolium* and *Eriophorum angustifolium*), in association with other species characteristic of peatlands such as *Erica tetralix*, *Scirpus cespitosus*<sup>1</sup> and *Calluna vulgaris*. *Sphagnum* species indicate reestablishment of the water table depth or the hydrological regime (Wheeler & Shaw, 1995; O'Reilly, 2008). Species selected as indicators will depend on the objectives of the restoration, and the stage of recolonisation at which recording begins. Certain plant species can also be clearly identified as 'negative' indicator species particularly where they form large, dense stands (Table 6). Negative indicators in this context would include *Juncus effusus*, a range of *Sphagnum* (*S. recurvum*<sup>2</sup>, *S. fimbriatum*, *S. squarrosum*) and other moss species (*Pleurozium schreberi*, *Dicranum scoparium*, *Hypnum cupressiforme*), indicative of drier or more enriched conditions, also, *Pteridium aquilinum*

---

<sup>1</sup> Also referred to as *Trichophorum cespitosum*

<sup>2</sup> Also referred to as *Sphagnum fallax*

(bracken), *Molinia caerulea* and *Eriophorum angustifolium*. Several studies focus on the control and management of such species, illustrating their status as important ‘negative’ indicator species (Todd et al., 2000; Milligan et al., 1997; Le Duc et al., 2003).

**Table 5** Suggested plant indicator species for monitoring progress towards a raised-bog objective (from Wheeler & Shaw, 1995).

Species	Notes
<i>Sphagnum cuspidatum</i> , <i>S. recurvum</i>	Often colonise areas with open/standing water
<i>S. papillosum</i> , <i>S. magellanicum</i> , <i>S. capillifolium</i>	Indicate satisfactory development of bog species
<i>Eriophorum angustifolium</i>	May invade precursor floating <i>Sphagnum</i> carpets, or root directly into peat
<i>Erica tetralix</i> / <i>Scirpus cespitosus</i> / <i>Calluna vulgaris</i>	These are only indicators of ‘success’ if associated with peat-forming Sphagna (e.g. <i>S. papillosum</i> ) as they are also constant species of wet heath communities
Other ‘desirable’ species include: <i>Vaccinium oxycoccos</i> , <i>Narthecium ossifragum</i> , <i>Drosera</i> spp., <i>Rhynchospora alba</i> , <i>Andromeda polifolia</i> , <i>Sphagnum subnitens</i> , <i>S. pulchrum</i> , ( <i>S. fulcrum</i> , <i>S. imbricatum</i> )	
‘Weed’ species, including birch/pine/ <i>Molinia</i>	Reduction in vigour and spread of these species (through rise in water levels and vegetation management) would be generally regarded as indicative of ‘success’

**Table 6** Vegetational indicators of potential problems with respect to revegetation with bog species. Note that in many cases it should be possible to mitigate the effects of adverse conditions through management and it should not be assumed that these are necessarily irreversible (from Wheeler & Shaw, 1995).

Species	Potential problem
<i>Juncus effusus</i>	May indicate a eutrophication problem and/or disturbance
Birch/pine/Calluna/Molinia/Rhododendron	Extensive invasion probably indicates conditions are too dry
<i>Sphagnum recurvum</i> , <i>S. fimbriatum</i> , <i>S. squarrosum</i> .	May indicate some base or nutrient enrichment (atmospheric deposition)
‘Heathy’ Sphagna (e.g. <i>S. tenellum</i> , <i>S. compactum</i> , <i>S. molle</i> ; plus other bryophytes (e.g. <i>Pleurozium schreberi</i> , <i>Dicranum scoparium</i> , <i>Hypnum cupressiforme</i> )	Although these species may be present in small quantities in M18a vegetation, their establishment and spread in the absence of the aquatic or main peat-building Sphagna would suggest that conditions are not generally sufficiently wet
Fen species (e.g. <i>Typha</i> , <i>Phragmites</i> , <i>Salix</i> , <i>Alnus</i> )	Indicates minerotrophic water source and nutrient enrichment
‘Weed’ species e.g. bracken, <i>Rumex acetosella</i> , <i>Chamerion</i> , <i>angustifolium</i> , Poaceae (e.g. <i>Calamagrostis canescens</i> )	Suggests that conditions are too dry and possibly disturbed

Dargie (2003) reviewed the main methods of floristic assessment undertaken on three different lowland raised bog sites affected by peat cutting operations as summarised in Table 7. The approaches are similar but the study indicates a need for greater uniformity of methods, which the author indicates is in part addressed by Common Standards Monitoring methods, for designated sites at least. However, an important point noted by many authors (e.g. Dargie, 2003; Ross & Cowan, 2003; Mawby, 2003) is that although lowland raised bog sites may have the same overall restoration aims (to re-wet the surface, reduce hydrological fluctuation, increase the cover and diversity of wetland species, to reduce cover of bare peat) the combination of restoration techniques able to be used on any one site has to be selected on a site by site basis. This is because restoration is driven not only by ecological factors but also by budget, human resources, landowner agreement, adjacent land use, access difficulties, and many other non-ecological issues. In addition, as more funds are attracted as the interest in the site increases, as for example, seen at Glasson Moss (Mawby, 2003), the restoration and hence the monitoring regime is added to and can become complex over time. The focus needs to stay on the improvement of the site, and this may mean altering goals, target and restoration approaches during the restoration period.

**Table 7** Summary of the approaches to floristic monitoring on lowland raised bogs (Dargie 2003)

Method	Example	Details
Floristic monitoring of indicator species by subjective overall cover	Fenn's, Whixall and Bettisfield mosses	% extent of peat forming indicator species ( <i>Sphagnum</i> and <i>Eriophorum</i> ) in each management sub-section recording results in a set of classes.  5 year repeat.
Floristic monitoring of indicator species using belt transects	Humberhead peatlands	Indicators are defined as (1) likely peat forming species, ( <i>Sphagnum spp</i> , <i>Eriophorum spp</i> ), (2) <i>Andromeda polifolia</i> and <i>Vaccinium oxycoccos</i> as indicators of peat condition, and (3) <i>Juncus effusus</i> in early stages of succession.  Estimation of % cover of each species for 10m either side of the transect line.  % cover transformed to area estimates per sub-compartment , and data incorporated into GIS
Floristic monitoring of all species using belt transect and vegetation mapping.	Wedholme Flow	The quadrat data set records all vascular plants, bryophytes and lichens along belt transects within each restoration sub-compartment, and these data are analyzed to provide area cover measurements for each plant species that can be compared across sub-compartments and over time. These data are incorporated into GIS. For storage and manipulation.

The National Vegetation Classification (NVC) can be used for surveying and mapping vegetation. Phase 1 habitat survey can provide an initial “environmental audit”; this method is useful for broadscale habitat mapping, which enable a more targeted selection of areas of high conservation value for NVC-level analysis. The Countryside Survey (<http://www.countryside-survey.org.uk/reports2007.html>) is a unique study or ‘audit’ of the natural resources of the UK’s countryside and includes assessment of the UK’s lowland and upland peatlands. The countryside is sampled and studied using rigorous scientific methods, allowing comparison of the present year’s results with those from previous surveys. This allows detection of the gradual and subtle changes that occur in the UK’s countryside over time. Maskell et al. (2008) provides details from the Countryside Survey 2007, which includes assessment of the UK’s lowland and upland peatlands. Table 8 provides an overview over the methods available and their applicability to different plant types.

**Table 8** Methods and their applicability to different types of plant (Bullock, 1996)

Key: \* always applicable, ? sometimes applicable, no symbol indicates that the method is never applicable to that plant type.

Monitoring scales and techniques	Trees	Shrubs	Grasses	Bryophytes	Fungi and lichen
Total counts	?	?	?		
Visual estimates	*	*	*	*	*
Frame quadrats	?	?	*	*	*
Transects	*	*	*	?	?
Point quadrats			*	*	
Harvesting	?	?	*	?	?
Plotless sampling	*	?	?		
Marking and mapping	*	*	*	?	?
Vegetation mapping	*	*	*		

#### 4.3.1.2. Sampling regimes

##### 4.3.1.2.1. Permanent sample plots

Permanent plots can be used as they detect changes in condition at specific locations (Clarkson et al. (2004). Permanent plots are marked quadrats or areas for vegetation monitoring in regular intervals (e.g. yearly) (Davidsson et al., 2000). Goldsmith (1991) and Herben (1998) summarise and discuss principal considerations of permanent plot studies. Maskell et al. (2008) provide relevant information on the permanent plots used in the Countryside Survey in which surveys have been repeated over the last 29 years, permitting large-scale yet fine-grained change in vegetation over time to be documented. Quinty & Rochefort (2003) recommend the permanent plot sampling as it gives a closer look at the vegetation cover for a given sector of a restoration site.

To provide a representative image of the development of a whole restoration site, a number of permanent plots must be installed at appropriate locations. Plot locations are selected on the basis that they are a representative sample of the typical plant community within the vegetation type, e.g. characteristic species composition, uniform habitat, and plant cover as homogeneous as possible

with no obvious community boundaries (Clarkson et al., 2004). Plots may be established in each of the main vegetation types within a peatland so that species-environmental relationships can be characterised (Clarkson et al., 2004). The number of plots depends on the size and diversity of a site: large and more variable sites need a larger number of permanent plots. Plot size should not be too large in order to allow the detection of all plant species without disturbance of the plot. For statistical analysis of the data it is more useful to have a higher number of smaller plots than few larger plots (Davidsson et al. 2000). See *Size and number of sampling units* below.

An initial assessment using quadrats or aerial photographs could be performed to determine the number of plots required to achieve a certain level of precision as well as the number of quadrats required. The NVC users handbook provides excellent advice for the size of quadrat and monitoring strategy. Roberts-Pichette et al. (1999) provide an excellent protocol for monitoring terrestrial vegetation in permanent plots of different sizes from a range of ecosystems that are applicable to peatlands. A minimum of one plot per major vegetation type is suggested, although replicate plots are preferable. If the ecological pattern is heterogenous, or if there is mosaic of vegetation types, an attempt should be made to sample the variation, by establishing several permanent plots (Clarkson et al., 2004). Replicate plots will also be needed in order to know if an observation is due to a certain environmental factor or only a random effect (Davidsson et al., 2000). For the detection of trends and/or fluctuations in the data several statistical methods can be used (e.g. Jongman et al., 1987; Huisman et al., 1993).

Maskell et al. (2008) state that being able to repeat plots (by re-locating their exact location) is a very important aspect of the Countryside Survey. This is done by taking a photograph of the plot and also providing a paper map for plot relocation in the next survey. They also provide relevant information for the creation of new plots and how to mark them out using wooden stakes.

The representativeness of a permanent plot of the sector that it represents must be carefully evaluated. Other features such as bare peat, and any unusual elements are also noted. Quinty & Rochefort (2003) suggest that all plant species must be identified and their percent cover estimated visually except for mosses that are pooled together at this level. However, if time is not an issue species should be broken down into functional groups (e.g. Graminoids, dwarf shrubs, mosses) or groups of indicator species. Different mosses can be used to indicate ecohydrological status e.g. *Campylous*, *Polytrichum*, *Sphagnum fallux*, *Sphagnum magellanicum*. CSM for several upland habitats recommends separating pleurocarpous mosses from acrocarpous, and crustose from non-crustose lichens. The former in each case (pleurocarpous mosses and crustose lichens) can be used as indicators.

Given the major role of *Sphagnum* and other moss species in peatland restoration, it is important to get a precise estimate of the percent cover and the composition of the moss carpet (Quinty & Rochefort, 2003). Five quadrats, for example, may be equally distributed on each side of a plot, 50 cm from its margin. If the centre part of the permanent plot differs substantially from the margin, it is appropriate to place quadrats along lines across the plot. Commonly, a frame of the appropriate dimension is used. It is recommended to evaluate separately the total cover of the vegetation instead of adding the cover of each species. Dead plant parts are not considered as living plants but their presence could be noted (Quinty & Rochefort, 2003). Advantages and disadvantages of different sampling designs (random, systematic, stratified) are discussed by Knapp (1984), Økland (1990) and Goldsmith (1991). Plant species composition as species richness on permanent plots can be estimated using different methods as described below (see Knapp, 1984; Moore & Chapman, 1986; Økland, 1986; Goldsmith, 1991; Sutherland, 1996).

#### 4.3.1.2.2 *Random sampling*

Sampling theory emphasizes randomization in order to provide a probability structure for statistical analysis or to give credibility to the statistical model used (Gillison and Brewer 1985). Gillison and Brewer (1985) argue that randomization procedures may be counterproductive to the intent of ecological surveys, especially where the occurrence of natural pattern is known to be non-random. Data sets need to be representative of the full range of variability in biological patterns in response to variability in the environment (Grossman et al. (1994).

In vegetation surveys, two aspects of pattern recognition should be considered: (1) the recognition of the pattern itself (e.g., a specific peatland type) and (2) the frequency and distribution of patches of the pattern (i.e., spatial distribution, number and size of plant stands) (Godron and Forman 1983, Gillison and Brewer 1985). In landscapes, vegetation patch frequency and distribution vary as a scale-sensitive function of environmental complexity and the level of resolution of the vegetation classifications used to characterize the pattern (Gillison and Brewer 1985). This variability in landscape level vegetation configuration should be analyzed in terms of the driving variables (the abiotic factors) controlling the vegetation (Grossman et al. 1994).

It is often impractical to determine all of the individuals of a species within the study area or plots, and so estimates are determined from within random sample areas or quadrats since this overcomes biases and should result in representative coverage (Sutherland, 1996). However, Dargie (2003) suggests that for monitoring vegetation cover on raised bog surfaces the number of random quadrats required to gather adequate data may be prohibitively large for some schemes because of the high level of small scale variability of these habitats (i.e. the microtopography consisting of hummock and hollow formation). The number of quadrats required in a random sampling regime depends on the variability of the vegetation, and the size of the change in parameters over time that is dependent on the monitoring timescale.

An area to be sampled could be separated into a grid, i.e. 150 m long by 500 m wide. Pairs of random numbers can be drawn between 0 and 150, and 0 and 500 and quadrats can be placed at the intersection of these random numbers. Random numbers are best calculated using random number tables or a calculator random number function (Sutherland, 1996). Alternatively, GIS could be used to generate a set of randomly located points within the survey or monitoring area. ADAS located randomly selected plots using either a pre-determined bearing and distance from an easily identified mapped feature, or in featureless terrain, used a handheld Global Positioning System (GPS) (Kirkham et al., 2005).

Random sampling is not appropriate with localized effects of restoration or impacts along an ecocline. However, it should provide information about broad-scale, non-location specific vegetation change over the whole site, in a way which is highly amenable to statistical analysis provided that samples are re-randomised for each set of monitoring measurements.

#### 4.3.1.2.3 *Stratified random sampling*

In standard random sampling design, each spatial point in the landscape is given an equal probability of being sampled. Random placement of sample sites will not accurately reflect the full range of variability of the biotic and abiotic components of ecosystems at regional scales unless the sampling intensity is very high (Gauch 1982, Orloci 1978, Pielou 1984). To alleviate the shortcomings of standard random sampling, stratified sampling schemes have been used to provide both accuracy in the recovery of patterns and statistical validity (Grossman et al., 1994). This approach is useful when



(1) there are obvious differences in habitat within the survey area, (2) there is a requirement to report on location-specific changes throughout a site, (3) comparing different treatments such as a control site and restored site, (4) or different ecological or environmental characteristics are expected. This involves dividing the area into different habitats and then randomly sampling areas within each plot (Grossman et al., 1994; Sutherland, 1996). This approach has been used successfully over large heterogeneous areas with mostly unknown patterns. Transects are a form of stratified random sampling (pg. 52).

The advantages of stratified random sampling are that (1) you can ensure that the entire area is represented (random sampling may leave large areas without sample points), and (2) that it allows you to characterize separate areas of the site individually and compare between them. To a certain degree you can also apply different survey methods to different areas, if they have been characterized properly. Disadvantages are that it is limited in the statistical techniques that can be applied, and that the stratification may affect the interpretation of the results as reported for each area sampled.

#### *4.3.1.2.4 Size and number of sampling units*

Generally, a uniform size of a sampling unit (i.e. quadrat area, transect length) is desirable as this maximises the precision obtained (Greenwood, 1996). However, under some circumstances this may not be possible in which case weighted means may be considered. Smaller sample sizes will be more precise but less representative and will require greater replication. If sample units are so large that each one requires a huge effort, it will not be possible to take many samples during the whole study, thereby reducing the accuracy of the overall estimates of average numbers. The balance to be struck between a few large units and many small ones will vary from peatland to peatland. It should be considered at the planning stage of the monitoring protocol (Greenwood, 1996).

Grossman et al. (1994) provide details of plot sizes used for different vegetation types (Table 9). Quinty & Rochefort (2003) suggest at the permanent plot level, an area of 5m x 5m is delimited by posts in which the vegetation is described. Roberts-Pichette et al. (1999) for shrubs recommend 5m x 5m quadrats for most situations but, for densely packed shrubs, 2m x 2m quadrats may be suitable. ADAS used 8m x 4m nested quadrats (Kirkham et al., 2005) for moorland vegetation monitoring in Dartmoor ESA, whilst CSM use 2m x 2m and the NVC suggests 2m x 2m or 1m x 1m depending on the habitat. Clarkson et al. (2004) suggest 2m x 2m plots for monitoring of New Zealand wetland plants. The number of quadrats to make an appropriate sample is probably at least ten for 5m x 5m quadrats and probably at least twenty for 2m x 2m quadrats (Roberts-Pichette et al., 1999).

Quinty & Rochefort (2003) recommend estimating the percent cover of moss species, liverworts (Hepaticae) and lichens in a series of 20 quadrats of 25 cm x 25 cm located inside permanent plots. Roberts-Pichette et al. (1999) suggest plot or quadrat sizes of 1m x 1m for mosses, lichens and fungi. However, where individuals are small, numerous and densely packed, smaller quadrats (e.g. 50 cm x 50 cm, or 25 cm x 25 cm) may be more appropriate. The number of quadrats necessary to adequately sample the ground vegetation is probably less than 50 (Roberts-Pichette et al., 1999).

The accuracy of the overall estimate depends on the square root of the number of replicate samples. Thus, to halve the width of the confidence interval, one needs to quadruple the number of replicates. Considerations of cost, time and the amount of information required will determine how many samples can be taken.

**Table 9** Guidelines for determining plot size (Grossman et al., 1994)

Class	Area (m <sup>2</sup> )	Dimensions (m x m)
Forest	100 – 1,000 m <sup>2</sup>	10x10 – 20x50
Woodland	100 – 1,000 m <sup>2</sup>	10x10 – 20x50
Sparse Woodland	25 – 1,000 m <sup>2</sup>	5x5 – 20x50
Shrubland	25 – 400 m <sup>2</sup>	5x5 – 20x20
Sparse Shrubland	25 – 400 m <sup>2</sup>	5x5 – 20x20
Dwarf shrubland	25 – 400 m <sup>2</sup>	5x5 – 20x20
Sparse Dwarf shrubland	25 – 400 m <sup>2</sup>	5x5 – 20x20
Herbaceous	25 – 400 m <sup>2</sup>	5x5 – 20x20
Nonvascular	1 – 25 m <sup>2</sup>	1x1 – 5x5

#### 4.3.1.3. Plant species

##### 4.3.1.3.1. Total counts

In this method, every individual of a species or the total number of species (species richness) in the sample area or quadrat is counted. This can be used for plants but has two drawbacks (Sutherland, 1996):

1. Hard to distinguish individuals of clonal plants where the genetic individual (genet) may consist of connected ramets; and
2. Variety in the size of plant will mean that density measures fail to collect information about the relative dominance of species in the community under study.
3. Time consuming

The first can be overcome by estimating the total number of ramets rather than genets. The second is a disadvantage and other monitoring techniques are used to take the size and density of plants into account. Also, because the study area is usually several orders of magnitude larger than the plants, this technique is often too time-consuming. However, it is suitable if a species has a low density and is easily spotted and the whole study area can be covered. The advantage of this method is that it measures the true density rather than sampling it and therefore has no biases (Sutherland, 1996). Vittoz & Guisan (2007) recently examined how reliable different methods for monitoring of permanent vegetation plots were. They concluded that lists of species are insufficient for monitoring. Whatever the sampling size, only 45-63 % of species were seen by all observers. However, the majority of the overlooked species had cover <0.1 %. Pairs of observers overlooked 10-20 % less species than single observers. It is therefore necessary to add cover estimates to allow for subsequent interpretations in spite of the overlooked species.

Species richness refers to the number of species present in a given area or in a given sample, without implying any particular regard for the number of individuals examined in each species (Sanjit & Bhatt, 2007). Species richness can be numerical (or simply “species richness”; Hurlbert 1971) or be related to area (or simply “species density”, namely the number of species present in a given area; Simpson

1964). It can be useful for noting the presence or absence of indicator species, or as a general indicator of biodiversity.

#### 4.3.1.3.2. Frame quadrats

Frame quadrats are usually made of four strips of wood, metal, rigid plastic, or tape, and cover an area large enough to be likely to encompass a reasonable number of species but not so large that identification and recording take too long. Quadrat size varies from 10 cm<sup>2</sup> for recording ground vegetation and mosses, to 25 m<sup>2</sup> or more for trees using tapes or corner markers. For large quadrats, it is useful to be able to dismantle the quadrat for transportation. For aquatic macrophytes a wood or plastic frame will float. Usually, the quadrat is divided into a grid of equal sized squares using regularly spaced lengths of string or wire. Frame quadrats can be used to record cover, density, biomass and/or frequency of occurrence of species. NVC surveys rely on quadrat sampling of vegetation stands (Bardsley et al. 2001).

Grieg-Smith (1983) describes a technique to determine the appropriate size of quadrat to give a representative sample for a study area. However, experience has shown that different vegetation types require different quadrat sizes (Bullock, 1996). Vegetation with smaller plants, greater plant density or greater species diversity should require smaller quadrats (Table 10).

**Table 10** Recommended frame quadrat size for specific plant communities (Bullock, 1996).

Plant type	Quadrat size (m <sup>2</sup> )
Bryophyte, lichen and algal	0.01 – 0.25
Grass, herb, and short shrub	0.25 – 16
Tall shrub	25 – 100
Trees	400 - 2500

Within each frame quadrat, the following measurements can be made:

1. Density – counting the number of individuals of each species within the quadrat;
2. Visual estimates of cover – e.g. percent cover:
3. Frequency – the percentage of the quadrats in which the species was present; and
4. Biomass – measured by destructive harvesting.

#### 4.3.1.3.3. Visual estimates of cover

Cover is a measure of the area covered by the aboveground parts of plants of a species when viewed from directly above. Grieg-Smith (1983) describes it as ‘the proportion of ground occupied by a perpendicular projection onto it of the aerial parts of individuals of the species’. Visual estimates of cover of the species are made either in the whole study area or in sample plots, such as frame quadrats. These estimates can be expressed as percentage cover of individual species, groups or features, or cover can be expressed in bands representing abundance such as DAFOR (dominant,

abundant, frequent, occasional or rare), Domin or Braun-Blanquet scales (Table 11). The DAFOR classes have no strict definition and the user must decide their own interpretation. Vittoz & Guisan (2007) found that the visual estimate of cover as a percentage was more precise than classes. However, because vegetation is layered, percentage cover values can sum to more than 100 %. Bullock (1996) recommend dividing the vegetation into layers e.g. bryophyte, herb and shrub layer, and make cover estimates separately for each layer, enabling a better representation of change in plant community composition over time.

**Table 11** The Domin and Braun-Blanquet scales for visual estimates of cover (Bullock, 1996).

Value	Braun-Blanquet	Domin
+	< 1 % cover	1 individual, with no measurable cover
1	1-5 % cover	<4 % cover with few individuals
2	6-25 % cover	<4 % cover with several individuals
3	26-50 % cover	<4 % cover with many individuals
4	51-75 % cover	4-10 % cover
5	76-100 % cover	11-25 % cover
6		26-33 % cover
7		34-50 % cover
8		51-75 % cover
9		76-90 % cover
10		91-100 % cover

Cover may be hard to estimate in tall vegetation although it is possible if you can look up at the canopy and estimate the cover of individual trees (Bullock, 1996). Clearly, this is not an issue for upland peatlands such as blanket bogs that consist of shrub and moss layers, but may be an issue on lowland peatland such as wet woodlands where tree canopy is present, or where trees are colonising a lowland peatland site that is drying out.

Bullock (1996) states that the advantage of cover compared to other techniques is speed. However, it can be inaccurate because of the subjectivity of the estimates. DAFOR is vague, and if several people are surveying then the meaning of the classes should be carefully agreed before starting. These precautions are also necessary if you use estimates of percentage cover. Often it is much easier and quicker to make visual estimates using frame quadrats.

Banded estimates of abundance, such as Braun-Blanquet and Domin are not so amenable to statistical analysis – only non-parametric tests can be applied when testing between results from different monitoring periods. Also, banded cover methods are incapable of detecting changes in cover that fall within bands. In some cases, surveyors make a percent cover estimate, and then convert it to the bands, thus representing a loss of information at the point of recording.

#### 4.3.1.3.4. Frequency

Frequency is a very quick and easy method if the quadrat size is standardized. This is because frequency is a qualitative measure (of presence or absence) which is used to calculate a quantitative percentage. Larger quadrats will usually be more likely to find the study species and will give higher frequency estimates than small quadrats (see nested quadrats, pg. 53). Frequency measurements

can be biased against species with a more clumped distribution (e.g. *Sphagnum*) and shoot frequency will be biased against smaller plants. For these reasons, Bullock (1996) suggests that great care is taken when interpreting frequency measures, especially when comparing different study areas. However, frequency measurements are less affected by seasonal environmental factors associated with cover measurements (Winward & Martinez, 1983), although care should be taken to complete the surveys when the species in question is observable (i.e. not dormant).

#### 4.3.1.3.5. Biomass

Aboveground plant parts are cut at a certain height from the surface usually at or close to ground level within an area defined by a frame quadrat. The plant material is taken to a laboratory in bags, washed of soil and sorted into species which can be time consuming. Each species is weighted to give a 'fresh' weight and then dried at 70°C for 1-3 days in an oven depending on species to give a 'dry' weight (which is a good measure of biomass). The scales used normally have an accuracy of 0.01 g (Bullock, 1996).

Biomass is a more usual definition of size but is biased towards species with a greater tissue density, such as woody species. Obviously, this method requires destructive sampling and thus consideration should be given that it is possible to replicate the sample again using replicated plots. Thus, it should only be used if you are certain that you need to measure the biomass of species, as with replicated plots a large area of restored vegetation could be adversely affected; for example, when the estimate is used in conjunction with estimating the C balance, i.e. net primary productivity. Also, samples can only be measured once, and therefore replicated plots are required to cover an entire monitoring period that could significantly affect an area of restored vegetation. This method is only really appropriate for vegetation such as short shrub or aquatic macrophytes. Indeed, harvesting of Bryophytes may be prone to errors as it is not possible to separate living from dead material as litter is not easily recognizable from peat. In this case, living pigmented tissue should be defined prior to harvesting and separated from brown or dead tissue in the lab. However, there is little relationship between annual production, green vs. brown biomass colour, and whether the material is living or dead (Wielgolaski, 1972; Vitt & Pakarinen, 1977). Green *Sphagnum* biomass changes to brown relative to hydrological conditions, so the green portion represents anywhere from only a portion of the annual season's growth to several years growth (Vitt & Pakarinen, 1977). Likewise, both Wielgolaski (1975) and Clymo & Duckett (1986) have shown that apparently dead, brown bryophyte tissue, often from some depth in the organic column, can reactivate under suitable conditions. Thus all biomass should be considered potentially alive unless the catotelm is reached, or for practical purposes, the average annual water table level (Vitt, 2007).

#### 4.3.1.3.7. Point quadrats

Point quadrats involve the use of single needles or groups of needles (usually 10) on a metal frame which are lowered vertically down onto a short sward and each species touched is recorded, in order to gain an objective estimate of the percentage cover of each species. To sample this you should identify the species of each living plant part that the tip (and only the tip) of the point quadrat hits on the way down to the peat surface. This gives a measure of only the presence or absence of each species. If all the hits on a species were counted, this would give an estimate of the total cover of a species, a measure which reflects the size of plants of a species as well as their abundance in the vegetation (Bullock, 1996). The presence/absence readings are summed to give a score for the whole frame for each species. The whole frame counts together as one independent measure and not each

individual point quadrat. Point quadrats are theoretically an estimate of frequency based on a number of samples of infinitesimally small area. Therefore the points should be as small as possible (1.5 – 2 mm diameter with a sharp tip). A plant can only be present or absent and therefore there are no cases of partial cover as with frame quadrats. This gives a true value of cover (Bullock, 1996). Grieg-Smith (1983) and Kershaw & Looney (1983) discuss the theory extensively.

Point quadrats are very time consuming but excellent for accurately determining the cover of species within a community and the vertical structuring of a plant community if the height at which each species was encountered by each point is also noted (Bardsley et al. 2001). Vittoz & Guisan (2007) found that the point method was the best method for cover estimate, but it took much longer than visual cover estimates, and 100 points allowed for the monitoring of only a very limited number of species. Small and rare species may be missed, or over-represented if hit, therefore this technique is best for accurate measurements of cover of larger or more abundant species. Bullock (1996) state that there is a sounder theoretical basis for using point quadrats to assess percentage cover than there is for visual estimates in frame quadrat, and canopy structure of short vegetation cannot be sampled as well by any other way. The vegetation should never overtop the point quadrat. The biases involved in cover estimates are discussed above.

#### *4.3.1.3.8. Transects*

Transects are commonly used to survey changes in vegetation along an environmental gradient or through different habitats (e.g. belt transects or gradsects). They are also used to estimate overall density or cover values of species in a single stand of vegetation by the line transect method (Bullock, 1996):

- Line transect – uses actual transect line as a surveying implement. The number of plants of a species that touch the transect line are counted to give a measure related to the density of plants;
- Belt transects – Frame quadrats laid out along the length of the transect. Cover or local frequency is estimated for each quadrat and the variation can be determined and correlated with gradients in environmental factors;
- Gradsects – gradient-directed transects laid to intentionally sample the full range of floristic variation over the study area. Usually used to sample very large areas sometimes hundreds of kilometres long (e.g. Austin & Heyligers, 1989).

A review and evaluation of the restoration techniques used on lowland raised bog in the Greater Manchester area has been undertaken in PAA (2002) and Ross & Cowan, (2003). The sites assessed comprised Risley Moss (85 ha), Astley and Bedford Mosses (92 ha), Holcroft Moss 919 ha) and Red Moss (47 ha). The current condition of these sites was investigated using a modified belt transect approach, adapted to each site, and including the mapping of areas of homogenous vegetation. Within the areas identified in each case, 2m x 2m quadrats were randomly placed and the plant species assessed using the DOMIN scale, including higher plants, bryophytes and lichens. In addition the percent cover of bare peat, open water and plant litter was recorded. A full list of all plant species within each area of vegetation was also recorded using the DAFOR scale and photographs taken. These quadrat data were collated and assessed using MATCH (Malloch, 1992) enabling the vegetation community type to be identified and affinities to the NVC to be assessed.

The belt transect survey approach identified that restoration techniques had been largely successful. However, the survey also found that repeating pre-restoration quadrat sampling points was impossible on some sites as increased water levels made access impossible to some areas of the site. Options for future monitoring arising from this survey work included periodic repeat survey along the same transect lines, together with simpler DAFOR assessments and general habitat descriptions on an annual basis. It was suggested that these approaches could be supplemented by an annual assessment of positive key species indicative of restoration success, such as *Sphagnum*, *Erica tetralix*, *Drosera rotundifolia* and *Vaccinium oxycoccos*. Additional negative species to monitor might include *Juncus effusus*, *Typha latifolia* and *Betula* spp.

For different vegetation types, it may be easier to use the line transect method than frame or point quadrats (Table 12). Cover estimates will be very difficult in vegetation where plants are small and intermingled. Belt transects can be very time consuming if a large number of quadrats are placed along them. If using transects, the count of touches or estimate of cover will often depend on the height of the line transect in the vegetation. Gradsects may be biased by the particular environmental factor used to describe the gradient. Transects should only really be used to demonstrate gradients (ecoclines), boundaries (ecotones) and changes in these. These gradsects will only really be appropriate where the location of a gradient is already known and for monitoring changes in this gradient, rather than to demonstrate the nature of the gradient.

**Table 12** Advantages and disadvantages of transects for certain vegetation characteristics (Bullock, 1996).

Vegetation characteristics	Advantage/Disadvantage
Sparse	Provides more productive sampling
Tall	More practical
Dense	Counting touches takes a long time
Tussocky, clumps or large/distinct	Length of transect occupied by a species can be measured reliably and simply

#### 4.3.1.3.9. Nested quadrats

The nested quadrat approach consists of 2 to 4 plots nested within a larger plot (Winward & Martinez, 1983). Species found in the smallest 'plot' are given a score of 1, additional species receive a score of 2, 3 or 4 depending on the plot in which they are first found. Percent frequency for each species at each 'plot' size can then be calculated, e.g. in plot 1: no. of plots with 1's/total no. of 'frames' sampled. Nested frequency methods are less likely to exclude species, or generate frequencies of 100%. They take a similar length of time to assess as a single-sized 'plot'. Data can be evaluated from selected plot sizes as the frequency changes.

A nested quadrat approach was undertaken as part of the monitoring of the impact of management regimes for the restoration of upland blanket bog (PAA, 2006). The approach identified areas of homogeneous vegetation types where restoration management was to be undertaken (e.g. burning, introduction of cattle grazing, changes in sheep grazing, *Molinia* cutting). Within each area, 32 1m x 1m quadrats were randomly set out. Each quadrat was divided into cells to create a nested quadrat, starting in the lower left corner of the 1 m<sup>2</sup> quadrat, and working out with each cell approximately doubling in area and fully containing all smaller cells. The approach was a modified version of the

ADAS plot method (Critchley & Poluton, 1998; Burke & Critchley, 1999), the modification being that the quadrats were randomly taken within the sample area, rather than being fixed within the designated plot area. This was to reduce surveyor trampling effects over time on the more vulnerable peat substrate and *Sphagnum* species. In addition, fewer small scale 'nests' were used between 1cm and 12cm nests than originally developed for grassland monitoring, as the scale of variation in moorland vegetation was considered 'more coarse', and monitoring to a fine scale was not considered appropriate in terms of resources/time.

In this study, the nested cell sizes were 1 cm x 1 cm (i.e. a 'pin hit'), 12 cm x 12 cm, 25 cm x 25 cm, 50cm x 50 cm, 70 cm x 70 cm and 100cm x 100 cm. However, a larger quadrat and/or more finely 'nested' quadrat can be used depending on the vegetation type being assessed. Each additional plant species found in each cell was recorded and a cumulative species list gathered for the area, along with a note of the cell in which the species was first recorded. The method can use a pre-determined plant species list to reduce time in the field, where appropriate. The benefit of this system over percent cover, is that the entire 1m<sup>2</sup> area is searched systematically and the nested approach reduces surveyor error.

The analysis of nested quadrat data requires a specific approach. The optimum scale for each species recorded is calculated. This is the nested quadrat ('cell') in which the frequency is closest to 50% of sample points measured. In the case of PAA (2006), the mid-point value was 16 as there were 32 quadrats in each sample area. The value of using the optimum scale is that it allows the plant to be monitored at the nested quadrat size that is considered most appropriate to detect changes in frequency for that species. Critchley and Poulton (1998) define optimum scale as 'the scale which is most sensitive for detecting change *a priori* in either direction'. The optimum scale for each species is derived from the first dataset and subsequent datasets assess the change in occurrence of each species at that optimum scale. A positive score (i.e. more occurrences of that species at that optimum scale over time) indicates an increase in the species, and a negative score a decrease. In this study the moorland species were recorded at a variety of different scales and the method appeared to successfully show changes in the smaller and/or less abundant species that may have not been detected using visual estimates of percent cover. However, this study did not compare the method with any other, and this method has not been widely used in peatland habitats, therefore it is difficult to fully assess its potential as a successful monitoring approach for these habitat types.

#### 4.3.1.3.10. Monitoring of plant populations

Davidsson et al. (2000) provide guidelines for monitoring wetland functioning which is a key goal of peatland restoration success. They state that monitoring of plant population dynamics is normally carried out for a selected species, e.g. for rare species as target species in nature conservation (Hutchings, 1991). However, for precise analysis of population dynamics and for the interpretation of the results, it is not sufficient to estimate the cover or frequency of a species. Information on the age, size and/or developmental states of the individuals within a plant population is needed for the evaluation of population viability (e.g. Oostermeijer et al. 1994; Frankel et al. 1995). Repeated population mapping and long-term observations of marked individual plants can illustrate positive or negative trends in population development.



#### 4.3.1.4. Plant communities

##### 4.3.1.4.1. Phase 1 habitat survey

The aim of Phase 1 habitat survey is to provide, relatively rapidly, a record of the semi-natural vegetation and wildlife habitat over large areas of countryside (JNCC, 2007). The Phase 1 habitat survey manual (JNCC, 2007) presents a standardised system for classifying and mapping wildlife habitats in all parts of Great Britain, including urban areas. The manual provides information on the planning and execution of habitat surveys and is based on the experience of a large number of surveys which have been carried out in the past decade. The methodology manual is applicable both to surveys of specific habitats and to surveys of the whole countryside, in which every parcel of land is classified and recorded. However, for monitoring of restoration the Phase 1 habitat categories applicable to peatland habitats are rather broad and there would need to be a significant change in vegetation community type to register as a change in category.

##### 4.3.1.4.2. National Vegetation Classification (NVC) System

The NVC was commissioned in 1975 by the Nature Conservancy Council (NCC) to provide a comprehensive and systematic catalogue and description of the plant communities of Britain. It has now been accepted as a standard, not only by the nature conservation and countryside organisations, but also by forestry, agriculture and water agencies, local authorities, nongovernmental organisations, major industries and universities. It has been widely welcomed as providing a much-needed common language in which the character and value of the vegetation of this country can be understood.

The NVC details methodology for sampling and describing vegetation in the field, and explains how such information can be used to identify plant communities, outlines the character of the classification itself, and accounts of the vegetation types it contains. It also discusses the important issues involved in carrying out an NVC survey of a site and gives a brief indication of other applications of the scheme.

The NVC approach divides vegetation communities such as the *Erica tetralix* – *Sphagnum papillosum* raised and blanket mire (M18) and ‘sub-communities’ such as the M18 *Andromeda polifolia* sub-community (M18a) (Rodwell, 1991). The sub-community is identified by a sub-set of plants (the preferential species) that are more frequently present (although not always at a high percent cover) within that sub-community than in the community as a whole. At the community level, as for Phase 1 habitat surveys, a fairly large change in plant community would be required for a change from one community to another to be registered during monitoring. However, a change between sub-communities can result from more subtle changes to plant species which may be detected. In addition, analysis packages such as MATCH (Thomson, 2004) will assess the difference between sets of quadrats in some detail allowing the ecologist to determine small changes in cover and/or frequency even if overall community type does not change.

##### 4.3.1.4.3. Higher Level Stewardship (HLS) vegetation type

The HLS, which is part of the suite of Environmental Stewardship agri-environment schemes run by Defra, also uses a rather broad classification for vegetation types some of which cover peatland habitat types (NE, 2005; 2008). These include wet grassland, moorland and upland rough grazing, lowland heathland and wetlands (including reedbeds, fens and lowland raised bog).

Each vegetation type has a suite of land management options, some of which cover restoration of habitat types, each of which has a set of criteria that should be met, and which are refined on a site by site (farm) basis. These criteria and the land management associated with them comprise the HLS agreement and form the basis of the subsidy payments given. The agreements where there were options dealing with peatland restoration could be assessed in a broad way (nationally or regionally) to see how much peatland was being managed under each option type. However, the data gathered for each agreement would be unlikely to be suitable for any detailed analysis of the success of restoration.

#### 4.3.1.4.4. CORINE Biotope Classification Scheme

The CORINE (CO-ordination of INformation on the Environment) biotope classification scheme (Commission of the European Communities, 1991) is a European habitat classification scheme which links to the EC Habitats Directive Annex 1 habitat types used to classify SACs. The classification scheme is hierarchical with the top level habitat types being rather broad (raised bog, blanket bog, water fringe vegetation, fens, transition mires and springs, etc). However, the scheme becomes increasingly detailed, for example describing the dominant *Sphagnum* species on hummocks within raised bogs. The scheme includes a large number of habitat types that are not found within the UK and, while its use for describing UK SAC sites is critical, its application as an approach for peatland restoration monitoring is more suited to large scale pan-European assessments. Since it generalises information into groups, communities and vegetation types, it has a lower capacity for detecting change than specific measurements or estimates of individual parameters. Jackson (2000) has prepared guidance on the interpretation of Annex 1 habitat types (which link to CORINE) to the more widely used UK classification schemes such as the UKBAP Broad Habitat Classification and Priority habitat types, NVC and Phase 1 habitat types. Again, these approaches are perhaps more useful as descriptive tools or strategic evaluations or restoration effort/approaches at the national or regional level rather than monitoring tools for peatland sites.

#### 4.3.1.4.5. Fixed point photography

Plant communities, their species composition and extent of habitat distribution can be surprisingly well recorded through regular standardized photographic surveys. While an accurate estimate of species abundance or mix will seldom be possible, these surveys are rapid, repeatable and inexpensive. With digital formats widely available they can be easily stored and analysed such as a time series of pictures. It is useful to take photographs (if possible from fixed points) at every field visit to provide visual histories of changes and to support monitoring of only rarely visited sites and sites for which monitoring resources are limited. Fixed photograph points can be marked by permanent electronic markers (e.g. magnets placed beneath the surface), or wooden/metal posts. In every case it is useful to reference permanent structures on and off site (by direction and distance). Fixed point photography was deemed important at the NE expert workshop (Appendix 2) but often not well used. It was suggested that it can be used horizontally or vertically. Also, it was considered good to record every quarter to see seasonal changes and to use aerial photos where possible.

This is a relatively simple and quick method of recording change in vegetation (and other site parameters, such as raising water levels by grip blocking) over time for monitoring purposes. A simple but consistent approach is needed to setting up an effective fixed point photographic monitoring scheme (K. Longden, pers. comm.), as follows:

- Accurately record the point the photograph is located, preferably with a fixed marker such as a wooden stake or by accurately measuring the point from a nearby fixed feature.
- Record the direction, including the marker in the photograph if possible to aid re-orientation. Also, include a scale marker such as a ranging pole or meter rule to aid future interpretation.
- Note any camera settings used such as zoom, speed, light settings, as needed.

The technique can be used to monitor the vegetation horizontally or vertically and in some cases a stereoscopic pair of photographs has been used to aid interpretation of vegetation change over time (Lindsay & Ross, 1993). The frequency of monitoring will depend on the restoration technique used and vegetation changes anticipated. However, seasonal changes can be useful to record by photographing every quarter. If applying only once a year, the photograph must be repeated at the same time of year to reduce the influence of seasonal change. An example of fixed point photography has been used to good effect in peatland monitoring is seen in the post-burn monitoring of Fylingdales blanket bog in North Yorkshire (Manners, 2009). Whilst photography does not provide primary data for analysis like vegetation or peat surveys, it may be possible to quantify vegetation change by point photography time series (see Clark & Hardegree, 2005). This suggests it may also be possible to assess differences in vegetation types between treatments. Stoneman & Brooks (1997) provide detailed information to consider when setting up a fixed point photography scheme (Fig. 5).

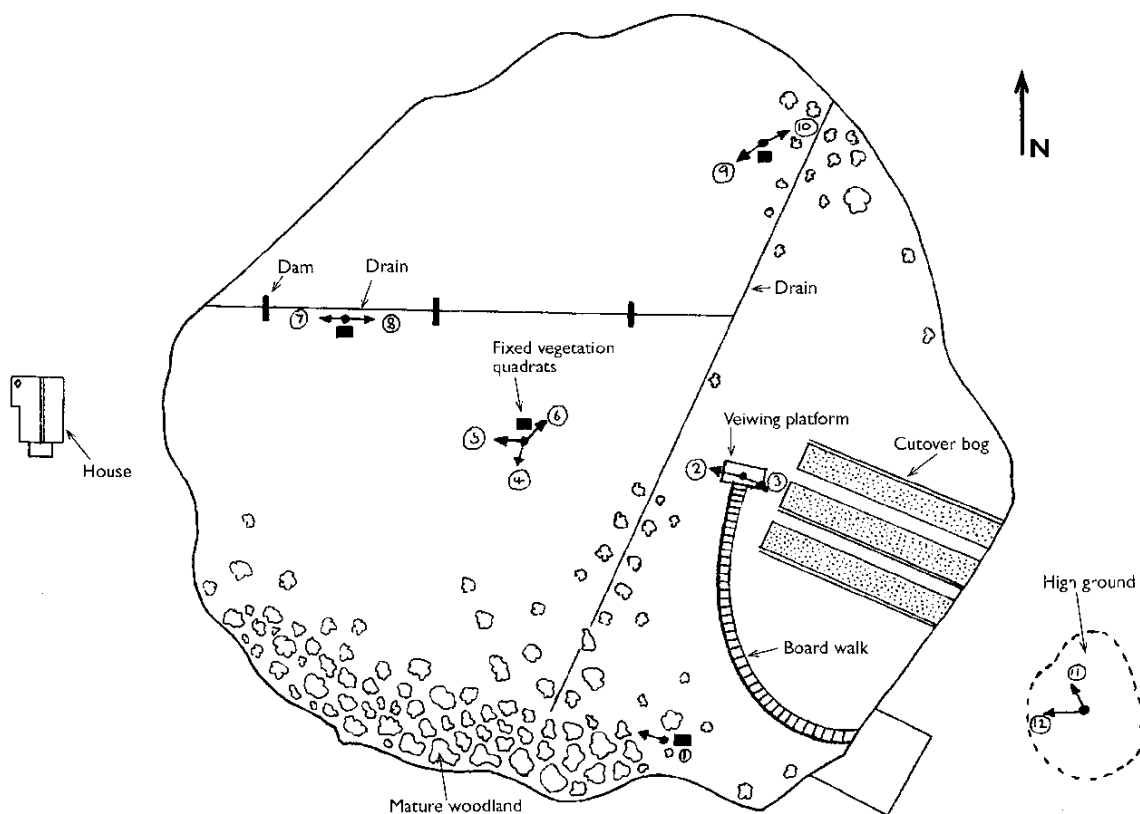

**Figure 5** An example of fixed-point photograph locations (from Stoneman & Brooks, 1997).

#### 4.3.1.4.6. Remote sensing

Since different vegetation reflects different parts of the visible and UV spectrum, vegetation types can be identified from satellite images. Some of the higher resolution satellites provide information on vegetation types at the field-scale. This data can provide information on the changes in land-use in recent years. Use of satellite remote sensing is useful for broad-scale habitat monitoring and surveying projects, for instance the Countryside Survey (Bardsley et al. 2001). However, there is a requirement for several data sets over a number of years which can considerably increase the cost and may be unavailable. It is good at distinguishing bare peat from vegetated peat, but it cannot distinguish purple moor-grass from other moorland grasses in the summer (Appendix 2). There is currently work focused on the potential for satellite imagery to distinguish purple-moor grass by comparison of summer and winter images, to recognise the colour change associated with its deciduous habit.

Mathema (2005) investigated the potential application of canonical ordination method in mapping and monitoring the transition of species composition as a result of rewetting degraded peatland bog in the Netherlands, by relating the floristic data with remotely sensed spectral data and indices. Linear ordination method was found to be appropriate for analysis of the floristic data. The application of Principle Component Analysis revealed presence of a moisture gradient in the floristic data. Therefore, redundancy analysis axis, a direct gradient analysis was carried out to ordinate the floristic data in relation with the remotely sensed spectral data and indices, namely: Land Surface Temperature, Normalise Difference Vegetation index, and Temperature Vegetation Dryness index. The majority of the pixels of the study area fell within the range of 0 to 1 of the first RDA axis indicating that the wetter species composition was re-establishing. It was inferred from the study that the interaction between the vegetation cover and the surface moisture was the compound environmental gradient responsible for the on-going transition in the vegetation community. Thus, the study shows the potential for linking remotely sensed spectral data and indices with vegetation monitoring to determine the extent of restoration success.

Aerial photography can be a very useful tool in pre- and post-restoration assessment. Photographs from the 1940s and 1950s can provide a visual record of former land use but are often monochrome. Former land use can be compared with current land use to assess change and/or deterioration. The former extent of habitats may also be used to help set restoration objectives. An aerial photograph pre- and post-restoration can provide a record of broad-scale habitat change. Remote controlled aircraft can be a cheaper alternative to the use of light aircraft. This technique has been investigated by the RSPB and the Environment Agency to assess the growth of algae in response to increased nutrient inputs. The method was rapid and produced an on-site time saving of 75 % with associated cost savings (Bardsley et al. 2001).

Where large and homogenous areas have to be monitored, aerial photography or remote sensing is very useful (see Jackson et al. 1995; Poulin et al. 2002). On a smaller scale, positive results can be achieved by installing camera platforms or by using model aircraft or balloons (Stoneman & Brooks, 1997). The potential advantages and disadvantages of remote sensing techniques compared with more traditional vegetation and species surveying and monitoring are shown in Table 13.

**Table 13** Advantages and disadvantages of remote sensing (Bardsley et al. 2001)

<b>Advantages</b>	<b>Disadvantages</b>
Cover large areas	Expensive initial start up/capital costs
Give quick response if weather conditions permit	Expensive ongoing monitoring costs
Can produce cost savings if large areas are monitored for long periods	Requires specialist and/or equipment for data analysis
	Resolution is comparatively low

#### 4.3.1.5. Vegetation structure

##### 4.3.1.5.1. *Canopy and sward heights*

In herbaceous and shrubland vegetation, canopy height and stratification can be measured using pin probes at sample points, which are often arrayed along line transects or belts (Bonham, 1989). Range scientists have also developed the 'swardstick', which consists of a bar which slides up and down on a graduated vertical pole that, when properly calibrated, provides rapid estimates of sward height and density. Sward sticks tend to measure smaller areas more accurately, but many measurements may be required to get a good average. The size of the bar on the slider will affect the results, with bigger bars making higher vegetation heights more likely. Falling discs are an alternative and are supposed to give an average over a standard area but they tend to record higher values than sward sticks (e.g. Earle & McGowan, 1979).

In low vegetation, ground cameras have been used to estimate canopy height both from horizontal profiles and from vertical stereo photographic pairs (e.g. Ivanov et al. 1994). Hutchings et al. (1990) tested the use of ultrasonic rangefinders to estimate canopy height in grasslands and found the estimates of height and mass to be closely related to those obtained by direct swardstick measurements. Ultrasonic rangefinders are relatively inexpensive and therefore offer a good alternative where canopy and sward height measurements are required.

##### 4.3.1.5.2. *LIDAR*

Aircraft and satellite borne laser systems transmit and analyze monochromatic light that interacts with and is partially reflected by the illuminated surface (Davis & Roberts, 2000). LIDAR (light detection and ranging) laser systems measure the travel time of short pulses of light to estimate the sensor-surface distance, while more sophisticated systems measure changes in light quality to measure absorptive properties of the atmosphere (differential absorption LIDAR) or the velocity of a moving target (Doppler LIDAR). Beam divergence from airborne LIDAR systems can be widened to increase the illuminated ground area or "footprint", which typically ranges from 0.5 to 10 m. Time varying return signals from targets at different distances from the sensor are sampled at high frequency to construct a "waveform" of distances to targets along the flightline. The waveform of heights can be analysed to estimate the vertical distribution of vegetation and ground surface within the footprint (Davis & Roberts, 2000).

Milton et al (2004,2005) state that mapping of past drainage of bog and evidence of active or abandoned peat cutting could be achieved using a sensor which responds to subtle variations in

surface microrelief, such as radar, LiDAR or stereo air photo interpretation. Spatial patterns of healthy vegetation, saturated ground and standing water would be expected to have an expression in the spectral domain as well as the spatial domain (Fig. 6).

Clearly, one of the most important indicators of active raised bog is the presence of 'colourful *Sphagnum* species' and it is very likely that these will have a characteristic spectral response within the visible and near infra-red wavelengths. There is also some evidence from the literature that reflectance in the short-wave infra-red, around the shoulders of the water absorption features at 1.4mm and 1.9mm, varies considerably for different plant species commonly found on raised bogs. Although very few remote sensing systems exist that could measure these spectral features in detail, most sensors have some spectral capability in the visible and near infra-red region (Milton et al. 2005).

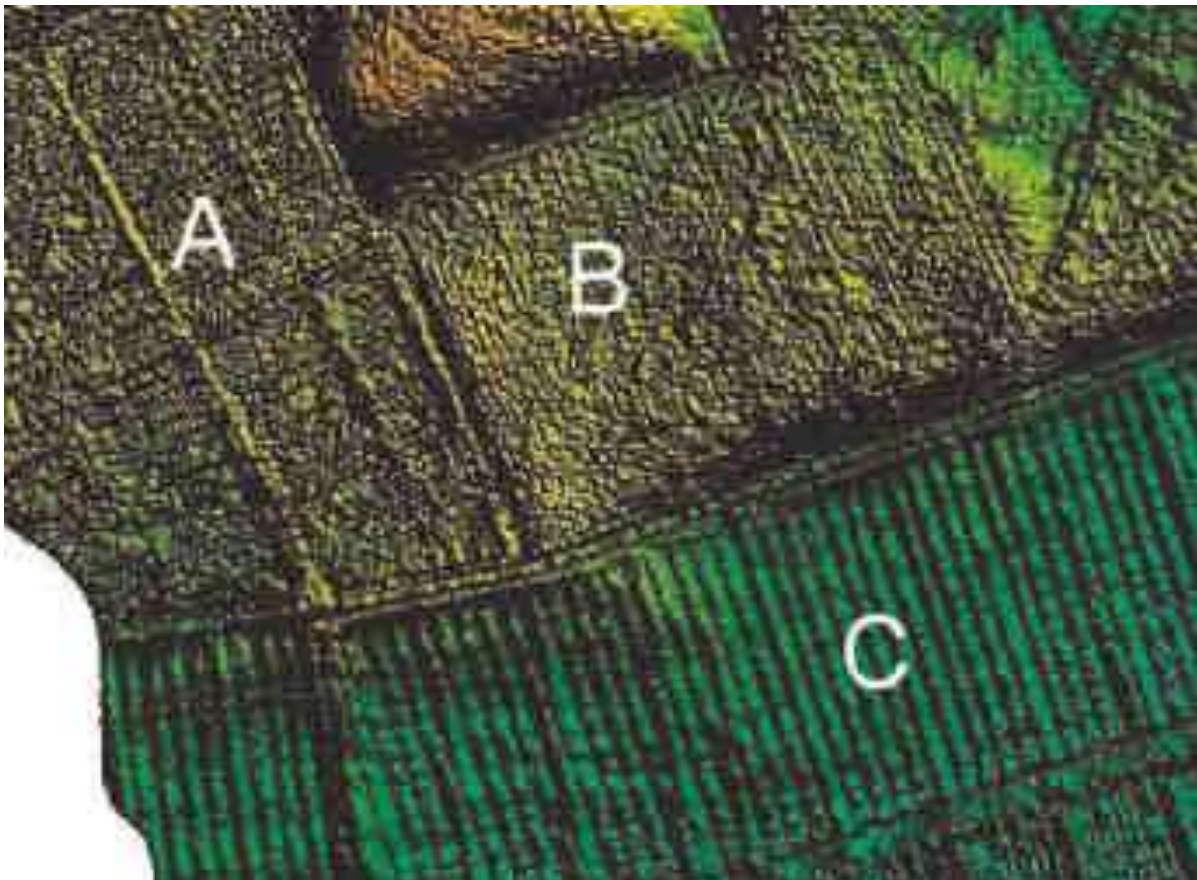

**Figure 6** Extract of the LiDAR data from Wedholme Flow showing how this data source could be used to distinguish between sod-cutting (A), degraded, drained bog (B) and milled peat extraction (C) (from Milton et al., 2005).

#### 4.3.1.6. Conclusions

The choice of method depends on the available resources and the scale of the site. Small permanent plots are recommended if they are adequately replicated for assessing vegetation change over time. Within large permanent plots, random sampling can be used to overcome biases. However, a large number of replicates may be required in raised bog surfaces that have a high level of small scale variability. Therefore, stratified random sampling can be used when there are obvious differences in

habitat, to compare a reference and restored site, or where environmental characteristics are expected. However, this technique is limited in the statistical techniques that can be applied. The point quadrat method is time consuming but gives precise data for a limited number of species, while frame quadrats are quick but allow for recording only large changes in cover. Braun blanquet and Domin are not amenable to statistical analysis. Frequency is very quick although biased against clumped species (i.e. *Sphagnum*). Transects are used when there is an environmental gradient. The nested quadrat may be the most appropriate technique where there is a wide range of vegetation types. The size of quadrat will depend on the vegetation types, i.e. shrubs, bryophytes.

Phase 1 habitat survey categories are too broad to be of use for peatland restoration monitoring. The NVC methodology may be more suitable for sampling and describing vegetation. Also, Higher Level Stewardship vegetation type covers restoration of habitat types with a set of criteria, although they are unlikely to be suitable for analysis of restoration success.

Fixed point photography is recommended for rapid, repeatable and inexpensive recordings of plant communities, species composition and habitat distribution. Whilst photography does not provide primary data for analysis, it may be possible to quantify vegetation change by point photography time series. Remote sensing techniques using low altitude, high resolution, colour and colour infrared photographs provide an accurate and efficient means of sampling vegetation cover, but individual species may not be identified, precluding estimates of species density and distribution. Aerial photography is suggested to be an effective tool for vegetation monitoring of simple habitat types dominated by a single species or when species identities are not important and vegetation structure is the main parameter to be recorded. However, the inability of aerial photography to identify individual species suggests it is limited in its usefulness for monitoring restoration success. LIDAR may be used to map past drainage of bog or the presence of colourful *Sphagnum* species in active raised bog. A combination of aerial photography and ground-based methods may be the most effective means of monitoring the success of large wetland restoration projects.

## 4.3.2 Birds

### 4.3.2.1. Introduction

Blanket bogs support a very wide range of birds. As with plant species, some of these are widespread and common, some are much more local, and quite a number are of international interest for either their rarity or for the densities of their breeding populations on blanket bogs, for example common scoter *Melanitta nigra*, dunlin *Calidris alpina* and Eurasian golden plover *Pluvialis apricaria*. Lowland raised bogs also support a distinctive range of birds including a variety of breeding waders and wildfowl such as bittern *Botaurus stellaris* which are restricted to reedbeds, which may form on cut-over raised bogs (e.g. Leighton Moss).

Birds are often used as biological indicators of environmental quality because:

- Many species are readily seen or heard and identified;
- Some species are top of the food-chains, acting as bioaccumulators of persistent pollutants (PCBs, etc.);
- All species are important contributors to habitat quality and extent such as invertebrate food sources for chicks, and some are very sensitive to pollution and disturbance;
- Birds are popular and being able to report beneficial results of peatland restoration for birds is likely to be good publicity for a restoration project – “Flagship species”.

Bird populations can change rapidly as a consequence of conservation management. Removal of large areas of scrub woodland and the creation of open water have a particularly strong impact (Stoneman & Brooks, 1997). This allows the success of management to be monitored via bird recording as a surrogate measure for habitat change. Other objectives of bird monitoring programmes are:

- To provide baseline data for previously unrecorded sites;
- To provide information on species that have particular conservation interest;
- To complement interpretation of hydrological and botanical data;
- To provide information to non-specialist audiences; and
- To supplement national bird monitoring programmes.

There are several standard techniques used in Britain and elsewhere that can be adopted for monitoring birds on peatlands. The Wetlands Birds Survey (WeBS) has used a nationally coordinated synchronised system of volunteer-based monthly winter counts for over 50 years (Bardsley et al. 2001). The Breeding Bird Survey aimed at monitoring populations of widespread and abundant species in the UK. The Common Bird Census (CBC) is another long-running volunteer-based survey of birds, designed to estimate national bird population changes through monitoring of sample survey sites. Also, see Brown & Shepherd (1991) for further details for monitoring breeding birds in peatlands.



#### 4.3.2.2. Common Bird Census

The Common Bird Census (CBC) principal aims were to measure the background variation in bird numbers and the extent of population changes due to pesticide use and habitat changes. A national picture is extrapolated from a series of sample sites (plots) which are recorded annually. Approximately 40 000 individual bird territories are mapped from 300 plots visited during March-July each year (Stoneman & Brooks, 1997).

A total of ten visits per year are made to the plot. On each visit, all birds seen or heard are recorded on a 1:2500 map. When all the visits are complete for the year, the information is transferred to a species map which, when analysed, shows the territories of individual birds. The result is a series of maps for each plot, species and season showing the number and position of each territory. These then form the basis for the extrapolated national picture. The fieldwork and mapping requires at last sixty hours of work, which inevitably limits the number of plots visited (Stoneman & Brooks, 1997).

#### 4.3.2.3. Breeding Bird Survey

The Breeding Bird Survey (BBS) was designed as a potential successor to the CBC and is used by the ECN. The scheme was designed to overcome the limitations of its forerunners (i.e. CBC) by:

1. Selecting sample sites randomly;
2. Increasing the number of sample sites;
3. Using counts instead of mapping territories, thus,
4. Reducing the sampling effort at each site, whilst
5. Improving representativeness.

One-kilometre grid squares are randomly chosen. Two parallel transects are established, 1 km long and 500m apart. Each transect line is divided into five equal sections of 200m, to provide a total of ten consecutively numbered sections. The habitats along the transects are described and coded (BTO, 1995). Habitat recording enables bird populations to be related to habitat features and to changes in those features. All bird observations are recorded at two visits (all species) as the observer walks the transect, and divided according to distance from the transect: within 25m, 25-100 m, greater than 100m and in-flight. The exact route taken by the transect lines is marked on a map and the same route is followed every year. In the lowlands of southern Britain, the main part of the breeding season, roughly between 1 April and 30 June, should be divided into two counting periods, early-April to mid-May and mid-May to late June, and one visit should be made in each period. Count should be made in the morning and should not be attempted in conditions of heavy rain, poor visibility or strong wind, and prevailing weather conditions should be recorded on the forms provided. An average visit takes approximately 1 ½ hours depending on the habitat (Stoneman & Brooks, 1997).

#### 4.3.2.4. Counting leks

In about 150 species of birds, males collect in communal display arenas called leks (Johnsgaard, 1994). These may be attended by males for much of the breeding season and much of the day, although females may attend them only briefly to mate. A single count at the peak time is usually

sufficient, provided the weather conditions are suitable. Prior to undertaking a full census, however, it is important to undertake counts throughout the day and the season at a small number of sites to determine how lek attendance varies (e.g. Cayford & Walker, 1991). The optimal timing for a full census can then be decided (see Gibbons et al., 1996).

In some species, calling males (e.g. Black grouse) can be heard from some distance giving away the presence of the lek. In other cases the lek arena itself may be obvious even when males are not present (flattened vegetation, droppings, feathers, etc.). Changes in land use may make the habitat surrounding a lek unsuitable and thus lek attendance may decline. This may not represent a population decline; rather the birds may have gone elsewhere. It is important to count all leks in a reasonably large area to determine changes in population level (Gibbons et al. 1996).

Most males in an area congregate at the lek and thus can be counted during a single count at the optimal time. Females of lekking species are usually inconspicuous and only visit the lek occasionally and thus cannot be counted reliably at leks. A few males may not be present at the lek, even at the optimal time. Young birds are particularly likely to be absent and may leak solitarily (Gibbons et al., 1996).

#### 4.3.2.5. Mist-netting

Birds can be caught early in the morning in spring and summer in fine-meshed 'mist' nets and, when the effort is standardised, 'constant effort sites' can be established. Several (12 or more) visits are needed to establish the local song bird population in a given area and standard samples are obtained year-on-year by using similar sized and located nets, set at well defined periods (Bardsley et al. 2001). It is essential to standardise catching time and the number of nets in a site.

Data on sex, age, body condition (weight) and young-to-old ratios as well as overall abundance of the various species can be obtained and birds ringed. Ringing returns are, of course, very useful ultimately for estimates of longevity, survival rates and migratory routes. This method can help interpret changes in population level by highlighting whether productivity or survival are possible causes of the population changes. Only workers holding a valid BTO ringing licence can legally ring birds or mist-net them in the UK.

Advantages unlike most other census methods are that capture per unit effort provides information on productivity and survival. It is useful for censusing species that live in habitats within which observation is difficult (e.g. dense undergrowth and reed-bed). The method is best for species with high retrap probabilities (e.g. warblers). Disadvantages are that long-periods of training followed by application for a licence are necessary before any ringing can be undertaken. In addition it is time consuming, sites are often chosen rather than randomly allocated, and habitat succession at sites can confuse the long-term picture. As a consequence it is not the most appropriate method for monitoring population levels (Gibbons et al., 1996).

#### 4.3.2.6. Point counts

Point counts can be an efficient way of collecting species abundance data. They are particularly good in scrub habitats, as they avoid excessive disturbance to the birds. They are not particularly well suited to large areas of open bog, as birds are disturbed on open bog (Stoneman & Brooks, 1997).

A point count is a count undertaken from a fixed location for a fixed time period. It can be undertaken at any time of year, and is not restricted to the breeding season. Points are selected either systematically or randomly within the study area. They should be spaced far enough to avoid duplication of individuals. Counts should last 5-10 minutes. Record all birds seen or heard. On longer counts, individuals may be recorded more than once. If a distance estimate is given for each record, a crude estimate of population density can be expressed (Stoneman & Brooks, 1997).

This method has no standard, national approach and could be readily adapted to suit individual needs and resource limitations (Stoneman & Brooks, 1997). Point counts are of little use for less detectable species. Because most birds are detected by song, a high level of observer experience is required. They are more suitable than transects where habitat is patchy, though much less so in open habitats where birds are likely to flee from the observer. Point counts are unsuitable for species which are easily disturbed. They are, however, very efficient for gathering large amounts of data quickly (Gibbons et al., 1996).

#### 4.3.2.7. Transects counts

Transect counts are particularly useful in covering large areas of open habitat. There is no standard methodology although there are a certain number of guidelines which should be adhered to (Stoneman & Brooks, 1997).

This technique is useful for monitoring both open and linear habitats (Bardsley et al. 2001). Transect lengths are variable; they are dependent upon habitat (longer for open habitat), ease of access and time limitations. They should be spaced widely enough to minimize the risk of duplicating sightings. Transects are walked and all birds seen or heard using the habitat can be recorded. Such data can yield density estimates when corrected for distances from the transect line at which birds can be identified. Supplementary information on behaviour, sex and so on can also be noted. This method may be particularly suited to bogs, as many species are flushed from cover as the recorder walks the transect route (Stoneman & Brooks, 1997). For further information, see Gibbons et al. (1996).

#### 4.3.2.8. Conclusions

Birds are often used as biological indicators of environmental quality as bird populations can change rapidly as a consequence of conservation management. The CBC and BBS methods are recommended as they are established techniques with available literature and data for detailed analysis and evaluation. These methods are also used by ECN at peatland sites and relate changes in habitat to changes in bird populations. Counting leks may be suitable for specific sites such as blanket bogs with grouse management. Mist netting is more expensive, time consuming, requires expertise and a license. However, more detailed information on productivity and survival can be obtained. Point counts are efficient and particularly good in scrub habitats, and open bog, although they are not good for less detectable species. Transect counts are useful in large open areas and linear habitats such as bogs.

### 4.3.3. Invertebrates

#### 4.3.3.1. Introduction

Peat provides habitat for terrestrial invertebrates such as millipedes, mites, collembola, enchytraeid worms, insects and arachnids. Invertebrates in upland moorland or bog habitats are an essential component of the diet of many bird species. Wet blanket bog is of great importance to many invertebrates such as spiders and leaf-hopper bugs. The vulnerable Bog hoverfly *Eristalis cryptarum* requires a habitat mosaic both within and beyond the bog. The natural structure of the surface of an undamaged blanket bog provides a variety of aquatic and semi-aquatic habitats each supporting different invertebrates. Rare and localised invertebrates, such as the Large heath butterfly (*Coenonympha tullia*), the Bog bush cricket (*Metrioptera brachyptera*) and Mire pill beetle (*Curimopsis nigrita*) are found on some lowland raised bog sites (Table 14).

Fen habitats support thousands of invertebrate species; at some sites more than half the UK's dragonfly species can be found, as well as a large number of aquatic beetles. Shallow-profiled water margins and ditch-sides are important for many invertebrate species such as the ground beetle *Pterostichus anthracinus*. Dykes with abundant Water soldier (*Stratiotes aloides*) support the Norfolk hawk dragonfly (*Aeshna isosceles*). River dredging has a negative impact on species such as the scarce chaser dragonfly (*Libellula fulva*). Some rare species, such as the crane fly *Prionocera subserricornis*, have aquatic larvae in ditches full of saturated organic 'mud'. Winter drying due to land drainage is likely to be especially damaging to the scarce emerald dragonfly (*Lestes dryas*). More detailed information on the species of invertebrates inhabiting peatlands can be found at <http://www.buglife.org.uk/conservation/adviceonmanagingbaphabitats/> (Table 14) and their monitoring (Eyre, 1996; Coulson & Butterfield, 1985).

**Table 14** Important BAP species associated with blanket bog, lowland raised bog and fen.

<b>Blanket bog</b>	<b>Lowland raised bog</b>	<b>Fen</b>
Bog hoverfly ( <i>Eristalis cryptarum</i> )	Blue ground beetle ( <i>Carabus intricatus</i> )	Desmoulin's whorl snail ( <i>Vertigo moulinsiana</i> )
Crane fly ( <i>Tipula serrulifera</i> )	a ground beetle <i>Pterostichus aterrimus</i>	Narrow-mouthed whorl snail ( <i>Vertigo angustior</i> )
	10 spotted pot beetle ( <i>Cryptocephalus decemmaculatus</i> )	Rosser's sac spider ( <i>Clubiona rosserae</i> )
	Large marsh grasshopper ( <i>Stethophyma grossum</i> )	Fen raft spider ( <i>Dolomedes plantarius</i> )
	Black bog ant ( <i>Formica candida</i> )	Lesser water measurer ( <i>Hydrometra gracilentata</i> )
		a ground beetle ( <i>Pterostichus aterrimus</i> )
		Pashford pot beetle ( <i>Cryptocephalus exiguus</i> )
		Diving Beetle ( <i>Bidessus unistriatus</i> )
		Large marsh grasshopper ( <i>Stethophyma grossum</i> )

Freshwater invertebrates are essential links in aquatic ecosystems. Peatlands provide ideal habitat for a large range of aquatic invertebrates. The greatest diversity of these species, on both bogs and fens, is in areas of standing water. Some species are truly aquatic, spending all their life in the water, while others have an aquatic larval stage but live out of the water as adults. Invertebrate communities are determined primarily by water chemistry and are therefore very useful for determining degrees of pollution (Table 15). The animals have to survive all through the year and therefore overcome the problems of point sampling (i.e. sampling on an arbitrary date may miss an event that may have a seasonal cycle) (Bardsley et al. 2001). The differing species or groups of invertebrates can be quite easily identified with a hand lens and appropriate field guide.

**Table 15** Pollution tolerant (low score) and sensitive (high score) aquatic invertebrate groups (Bardsley et al., 2001).

Group	Score
Small aquatic worms (e.g. <i>Tubifex</i> )	1
Chironomid midge larvae (e.g. bloodworms)	2
Asellus (water louse), most leeches and snails	3
<i>Baetis</i> (olive) mayflies, Alder flies ( <i>Sialis</i> ), fish leech.	4
Water boatmen, most water beetles and bugs, flatworms	5
Shrimps ( <i>Gammarus</i> ), mussels, freshwater limpets	6
Caenis mayflies, <i>Rhyacophila</i> & <i>Limnephilus</i> net-spinning caddis, <i>Nemoura</i> stone flies	7
Native crayfish, most dragonflies	8
<i>Ephemera</i> , <i>Leptophlebia</i> & <i>Ephemerella</i> mayflies, <i>Perla</i> , <i>Chloroperla</i> , <i>Leuctra</i> stoneflies, <i>Phryganera</i> , <i>Molanna</i> , <i>Leptocerid</i> , <i>Sericostoma</i> cased caddis flies	10

Scott et al. (2006) reported that epigeic spiders can be used as ecological indicators of conservation value for lowland bogs. They found that the number of spider bog indicator species was a surrogate for the conservation value of the total invertebrate fauna of the bogs in the study area. Arthropods form a large proportion of the cursorial epigeic fauna of *Sphagnum* bogs, beetles and spiders being the major predatory mesofauna. Eyre and Woodward (1996) regarded spiders of limited usefulness in the assessment of moorland and woodland situations as a result of year-to-year differences in catches and poorly defined habitat preferences, they also have the disadvantage that they can, in the main, only be identified to species when sexually mature. However, lowland oligotrophic bogs support a highly distinctive invertebrate community (Coulson & Butterfield, 1985). As these habitats have little vertical stratification, most of the spider species are accessible to pitfall trapping, which provides the nearest approximation to quantitative data (Scott et al. (2006). Several species are considered endangered and, as the subjects of BAPs in the UK, require monitoring in their own right.

The invertebrates form a large group in terms of species richness and many of them pose difficult problems for long-term monitoring: sampling for many groups is labour intensive, identification difficult, time-consuming and therefore expensive. Invertebrates were considered possible indicators of restoration at the NE workshop (see Appendix 2) but maintaining or enhancing populations of invertebrates might also be objectives of a peatland restoration project. However, invertebrate monitoring was considered costly in which case invertebrates would best be monitored where they are deemed a special feature of a site. In this case invertebrates would represent an objective which could be directly monitored. Further, cooperation of numerous taxonomic experts is essential for accurate species identification in most groups. This is evident from the list of experts involved in the studies by Blades and Marshall (1994) and Finnermore (1994). However, Blades & Marshall (1994) suggest that grouping of species by habitat preference is a useful technique for assessing habitat

disturbance and therefore may be suitable for peatland restoration. Luff & Woiwod (1995) provide guidance on the use of insects as indicators of change in climate, pollution and land use. The Environment Change Network (ECN; <http://www.ecn.ac.uk/protocols/index.asp>) concentrate principally on indicator groups rather than on individual species. Roberts provide keys for species identification (1985, 1987) with taxonomic revisions by Merrett & Murphy (2000). Specific bog indicator species are given in Ratcliffe (1977) with additional species cited by Tretzel (1955), Casemir (1976) and Kupryjanowicz et al., (1998).

Many invertebrates exploit different microhabitats during different stages of their life-cycle and are consequently only present in a given habitat for limited periods during the year. Thus, it is frequently necessary to devise sampling strategies for freshwater and peat invertebrates on a fine scale such as sampling a wide range of microhabitats (e.g. dead vegetation of different species and of different moisture content, bare ground, etc.). Special techniques are required for sampling the aquatic habitats encountered in bogs (Danks and Rosenberg, 1987). More sampling effort is usually needed both in forested areas and in the shrub and herbaceous habitats (Keener & Needham, 1999). It may also be necessary to sample on a number of occasions throughout the year, in order to obtain a representative selection of species present. The activity of most invertebrates is often strongly influenced by the weather conditions and the time of day. The level of activity, as mediated by the weather, may determine in which microhabitat a particular individual is at any one time, how easy the individual is to locate, how easy it is to catch, and how likely it is to enter a trap. When monitoring invertebrate faunas between sites, or at the same site over time, it will usually be necessary to standardise the weather conditions and time of day under which the sampling takes place. This is of particular importance when using traps (Ausden, 1996). Catches of individuals within a trap reflect the abundance and activity of a species, as well as the species susceptibility to being caught, e.g. attractants, distance to trap, etc. Keener & Needham (1999) suggest a sampling period over at least one or two years is needed to accommodate the different phenologies, and a variety of collecting methods are needed to sample the various faunistic elements. Stoneman & Brooks (1997) recommend that invertebrate monitoring should be linked as closely as possible with botanical, hydrological and climatic monitoring programmes.

The methods to achieve invertebrate monitoring can be divided into trapping techniques and direct counting techniques. Trapping techniques include pitfalls, water, light, flight and suction trapping. Direct counting techniques include transect walking, netting, and extraction techniques (see Stoneman & Brooks, 1997). A list of the advantages and disadvantages of survey methods available is presented in Table 16.

**Table 16** Survey methods: advantages and disadvantages (Stoneman & Brooks, 1997).

<b>Survey method</b>	<b>Advantage</b>	<b>Disadvantage</b>	<b>Cost</b>
<i>Trapping</i>			
Pitfall	Simple to use. Expertise not always required. No power source.	Methodologically unsound. Kills samples.	Very cheap
Water	Simple to use. No power source.	Kills samples. Standardisation difficult.	Very cheap
Light	Used at night. Traps sample alive.	Power source needed. Traps limited range of taxa.	Expensive
Flight	Samples large numbers. No power source	Samples large numbers. Kills large numbers. Standardisation difficult.	Cheap
Suction	Easily standardised. Comprehensive sampling.	Samples large numbers. Time consuming. Expertise essential. Poor in wet conditions.	Very expensive
<i>Direct counting</i>			
Transect walking	Simple. No expertise required.	Samples very limited range of taxa. Requires regular repetition.	Very cheap
Aquatic netting	Simple.	Standardisation difficult.	Cheap
Sweep-netting	Simple.	Standardisation difficult.	Cheap
Quadrat counting	Simple.	Can be inaccurate	Cheap
Sieving	Simple. Samples lesser known invertebrates.	Expertise required for identification of smaller taxa.	Cheap
Extraction funnels	Samples lesser known invertebrates.	Expertise required for identification of smaller taxa. Time consuming.	Moderate
Pooters	Simple. Can sample species not caught in traps.	No standardisation.	Cheap
Hand searching	Simple. Can sample species not caught in traps.	No standardisation.	Very cheap

#### 4.3.3.2. Trapping techniques

##### 4.3.3.2.1. Pitfall traps

Surface-dwelling invertebrates are often determined by using pitfall trapping, in which open-top traps are set into the ground level with the surrounding peat surface (Coleman & Crossley, 1996) (Fig. 7). It is a relatively simple and useful technique for sampling certain groups of invertebrates, particularly errant species such as ground beetles (*Carabidae*), rove beetles (*Staphylinidae*) and spiders (Stoneman & Brooks, 1997). Pan trapping and pitfall trapping are the main techniques used in the study of the terrestrial arthropod fauna in peatlands (Keener & Needham, 1999; Marshall 1994; Finnamore 1994). While this method is useful for surveys to assess the relative activities of macroarthropods, which is mostly sufficient to assess habitat quality, it has limited utility as a quantitative sampling technique (Dennison & Hodkinson, 1984). Many authors (e.g. Greenslade, 1964, Holopainen, 1990) have questioned the use of pitfall traps as a survey technique and discussed the relative attractiveness to invertebrates of the various solutions used in traps. It is argued that the 'catch' reflects invertebrate activity rather than abundance and that some species are always under-recorded (Stoneman & Brooks, 1997). Despite these drawbacks, it remains a useful technique, with the bonus on bogs that traps can be easily sunk in peat. However, consideration must be given to the possibility that traps may be affected by periodic high surface run-off.

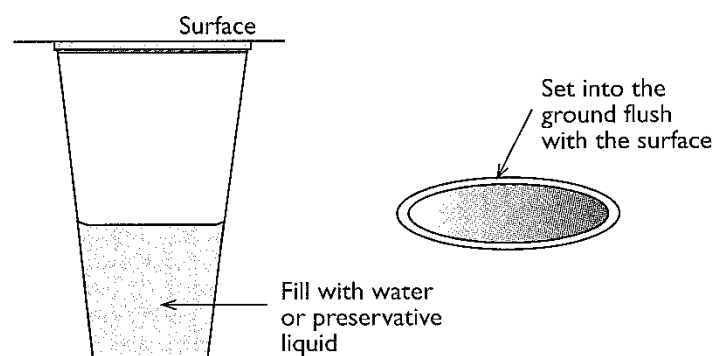

**Figure 7** A pitfall trap. Set into the ground, these intercept ground-dwelling insects, they are particularly useful for catching active predators (from Stoneman & Brooks, 1997).

For monitoring spiders, Scott et al. (2006) used continuous pitfall trapping with 25 traps per site (five traps per station, spaced at 1 m intervals in a line), using 75 mm diameter plastic beakers protected by ceramic tiles supported 2 cm above the rim and containing 30 % ethylene glycol in water as preservative with a small amount of detergent to prevent larger species crawling out. The pitfall catches were collected fortnightly and were supplemented by litter sieving and hand collection from emergent vegetation. Species identification was based on the keys of Roberts (1985; 1987). Data were analysed using two measures of diversity (Magurran, 2004). The inverse Simpson index reflects the evenness of species abundance, although it may be unduly influenced by common species. The Berger-Parker index was used as a measure of dominance. McGeoch (1998) stated that for a single invertebrate group to be used as a bio-indicator it is essential that it can be shown to reflect the quality of the total biota of the habitat. This was tested by data from the Welsh Peatland Invertebrate Survey (Holmes et al., 1991a,b; 1992; 1995a,b,c) that covered blanket bog, through raised, basin and valley mires to poor fen and calcareous flushes. The number of spider indicator species was positively correlated with the log of the total Red Data Book and Notable species in other



taxa suggesting that spider indicator species are an acceptable surrogate for the conservation value of the total invertebrate mesofauna. Using Scott et al. (2006) short-survey protocol and stopping rules, they suggest that adequate indication of a good peatland site can be assumed when the naturalness index exceeds 0.5, the species quality index (SQI) is  $> 1.8$ , and the indicator species-area relationship gives a datum point on or above a trendline. However, they state that the usefulness of this protocol for year-to-year monitoring remains to be tested. Relys et al. (2002) stated that there was no turnover in the abundant spider species in consecutive years if the pitfall trap positions remained constant, although there were marked annual differences in individual abundances. Scott et al., (2006) concluded that there seems to be sufficient basis for accepting spiders as ecological indicators for peat bogs as they satisfy most of the criteria suggested by McGeoch (1998). Although simple observations of the invasion of the bog surface by grasses and trees can give an indication of deterioration of the biotope by lowering of the water table and/or eutrophication, spider surveys may signal other changes that stress the mesofauna and its constituent valued species. The presence of adequate numbers of indicator species at low density may identify those degraded and cut-over bogs that would respond to restoration attempts, e.g., at Holcroft Moss (see also Oxford and Scott, 2003).

Holmes et al. (1993) provides a similar method to Scott et al. (2006) for a survey of ground beetle fauna of Welsh peatland biotopes. Coulson & Butterfield (1985) surveyed invertebrate communities of peat and upland grasslands in the North of England and found that pitfall traps had the advantage over sweep-net sampling, vacuum sampling and extraction of soil samples that they collected large samples of invertebrates which produced markedly more species than the other methods. The catch included many adult insects which could be identified to species and also many of the nocturnally active species missing from sweep and vacuum samples.

Stoneman & Brooks (1997) provide the following guidelines for bogs:

- All containers should be standard size and colour and spaced evenly along a transect.
- All should contain the same solution.
- Always mark the site of the traps well; they are surprisingly difficult to find again.
- Use preservative in solution if the trap cannot be checked at least every two or three days. An anti-freeze can be used in the winter months.
- Pitfall traps are useful in survey and monitoring in conjunction with management where, for example, there are different grazing regimes on an extent of bog with the same hydrological regime or to monitor the change in invertebrate fauna before and after rewetting.

#### 4.3.3.2.2. *Water traps*

Many flying insects are attracted to certain colours and can be caught in coloured water-filled bowls or trays (Fig. 8). Yellow bowls are the best for catching both flies and Hymenoptera (Disney, 1986). However, whilst white and yellow traps attract the greatest number of individuals, other colours, particularly black, may attract different species (Stoneman & Brooks, 1997). When painting trays, Stoneman & Brooks (1997) recommend using enamel paints as these tend to be resistant to water. The species composition varies with the elevation of the trap, thus it is recommended to set a number of traps at different elevations (Ausden, 1996). Conversely, if traps are being used to compare catches between sites, or at the same site over time, the height above the vegetation

should be constant. Traps should be emptied once a week and therefore if sampling only occurs once or twice per year, the traps should be set up one week prior to sample collection. Invertebrates are removed from the water by pouring it through muslin into a bowl.

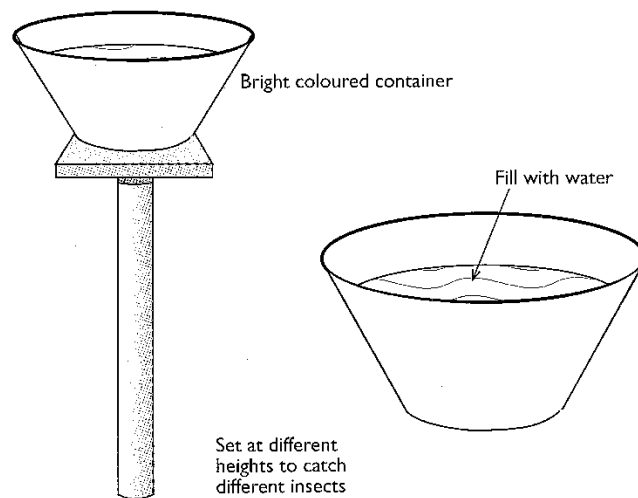

**Figure 8** A water trap (from Stoneman & Brooks, 1997).

Water traps do not provide absolute population estimates, nor do they attract the full range of flying invertebrates. They are, however, very cheap and simple to use and can be useful in determining which are the most common species at any one time. They can be used in all habitats. The critical habitats for most species are associated with their requirements for breeding. It may not be possible to determine the breeding locations for almost any species as finding a winged adult (often the only life stage that can be identified) at a particular site does not prove that the species breeds at that site. Disadvantages are that they must be constantly checked, may be affected by grazing stock or birds which may drink the water, and cannot be fenced off due to long-term effects on vegetation that will affect invertebrate numbers. Obviously, the traps are also restricted to species prone to being caught in water traps and therefore not much use for species which rarely fly. The traps will be biased towards the attractiveness of the traps including the preservative used (see Ausden, 1996).

For water traps to be of use in a monitoring programme, Stoneman & Brooks (1997) advise to set the traps regularly through the spring and summer months in order to include a range of weather conditions. Setting the trap only once or twice a year and then repeating this on the same date in subsequent years may give misleading results, as the sample taken depends upon the weather on that particular day.

#### 4.3.3.2.3. *Light traps*

Many night-flying insects, particularly moths, are attracted towards light, particularly that at the ultraviolet end of the spectrum. They can then either be actively caught, or encouraged to enter a trap (Fig. 9). The simplest light trap consists of a light on a cable hanging outside a building. Any bright white or bluish light is suitable, although a high-pressure mercury vapour bulb is best. Light traps can catch very high numbers of moths but are very variable according to weather conditions. Light traps have the advantage of catching insects alive and are therefore ideal for survey work. They can be useful for monitoring changes in the population of night flying moths in conjunction with

management practices. They are biased towards species attracted to light and therefore only reflect the activity of these attracted species (see Ausden, 1996). Stoneman & Brooks (1997) suggest using the same trap in the same place when monitoring population change from year to year. Also, always release the insects caught in the trap back to the same site. Scatter individuals over an area in and among undergrowth to prevent predation from birds.

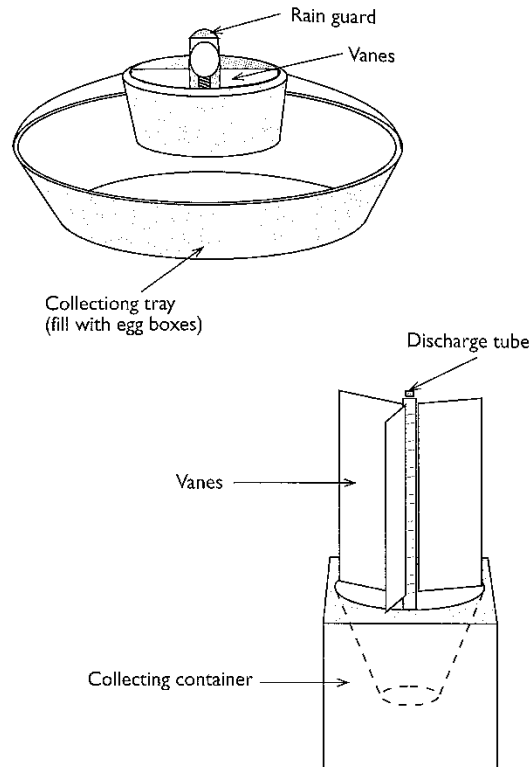
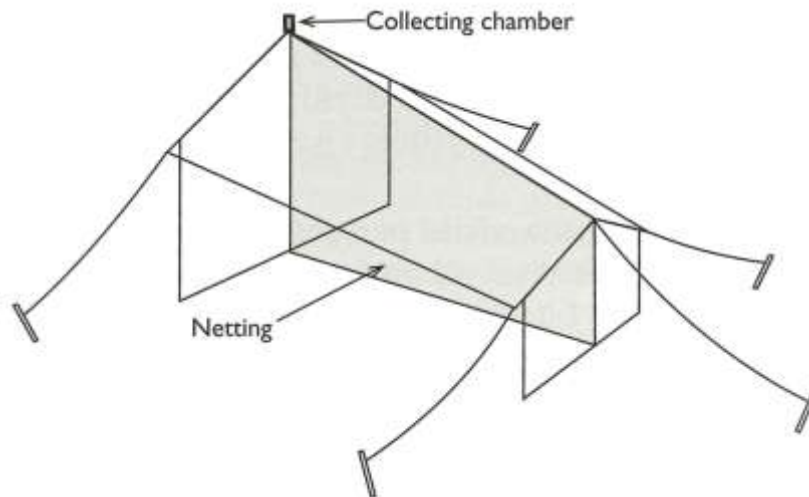

**Figure 9** A light trap can be used to collect night-flying insects. There are a number of designs in common use, of varying power, size and portability (from Stoneman & Brooks, 1997).

#### 4.3.3.2.4. Flying interception traps

Flight interception traps work by blocking flying insects with a screen of fine black netting. Blocked insects then drop down into collecting trays laid beneath the netting, or are guided upwards into a collecting bottle (Malaise traps) (Fig. 10). Malaise traps are designed to sample large numbers of flying insects, especially flies (Diptera) and wasps (*Hymenoptera*). Traps are relatively inexpensive and have the advantage that they do not require any power source and can, therefore, be taken anywhere. If the time and expertise is available to identify all the invertebrates sampled, then the traps become a very useful tool for examining populations and communities of winged invertebrates. Stoneman & Brooks (1997) recommend that malaise traps be used on small sites (a good example is a small lowland raised bog), as this could have a detrimental effect on local populations of invertebrates associated with, or adapted to, those sites. Similarly, malaise traps should not be used where an endangered species is known to occur. Traps are rarely used to compare numbers of insects between sites or at the same site over time, because their size tends to make replication impractical (see Ausden, 1996). Stoneman & Brooks (1997) provide the following guidelines:

- Change the bottle at least every two days in the summer months, as sampled invertebrates soon begin to decompose. If the site cannot be visited every two days, use alcohol to delay decomposition for approximately one week.
- Where there is scrub or woodland on the bog, place the trap at 90° to the edge of a block of trees – this catches the invertebrates hawking along woodland edges.
- Loosely place some vegetation or tissue paper in the collecting bottle along with the killing agent – this helps to prevent antagonism between individuals and increases the surface area within the bottle.



**Figure 10** A malaise trap. Flying insects hit a vertical wall of netting. They move upwards towards the light and are funnelled through a small hole into a collecting chamber (from Kirby, 1992 in Stoneman & Brooks, 1997).

#### 4.3.3.2.5. Aerial attractant traps

Flies can be attracted into containers holding suitable baits and then trapped within these or guided upwards into a collecting bottle. A wide range of baits can be used: rotting fruit for fruit flies, dung for dung flies, fungi, fish, rotting eggs, etc. To obtain the widest variety of species when using baits that decay, such as meat, it may be worthwhile leaving bait in different traps for varying periods of time since different fly species are attracted to meat in different stages of decay. For this reason, catches are biased towards certain flies, and flies already caught may attract other flies (Cragg & Ramage, 1945).

#### 4.3.3.2.6. Emergence trapping

Insect groups which have aquatic larval phases and which swim up to emerge at the water surface, include non-biting midges (chironomids), biting midges (ceratopogonids), some caddis and mayflies. Emerging flies can be caught in floating mesh-boxes buoyed up by polystyrene floats and emptied of their contents. To catch the flies, they need to be sprayed with dilute alcohol and grasped with tweezers, which can prove extremely difficult. Placing the trap quickly in a large polythene bag

increases the efficiency of the operation. Clearly, these techniques depend on the habitat such as fens where there is standing water.

#### 4.3.3.2.7. Suction sampling

Suction sampling involves the sucking up of invertebrates from a known area of vegetation into a net. The most commonly used purpose-built suction sampler is the D-vac, which is a large piece of apparatus, carried on a person's back. Two methods of monitoring invertebrates can be used. The collecting nozzle of the sampler can be pushed vertically downward into the vegetation and held there for a standard length of time (e.g. ten seconds) to suck up invertebrates from an area of vegetation the size of the sampler's nozzle. This can then be repeated many times. Alternatively, a known area of vegetation can be defined and enclosed, and the collecting nozzle used to suck up the invertebrates from it for a standard length of time. After the sample has been taken, the net bag containing the invertebrates should be sealed and placed in a killing bottle and its contents then removed and preserved.

Suction sampling is only effective in vegetation less than 15 cm high, which has not been flattened by wind, rain, or trampling. Like sweep netting, it cannot be used if the vegetation is damp and thus is probably not recommended for peatlands during wet conditions. Suction sampling collects fewer invertebrates per unit time spent in the field than sweep netting does. However, although extraction efficiency varies to some extent in differently structured vegetation, this is usually less of a problem than it is with sweep netting. Hence suction sampling may often be the preferred option for monitoring invertebrates in low vegetation and sweep netting the preferred option for monitoring them. Suction sampling under-records large invertebrates (>3 mm long) that can take shelter (e.g. hunting spiders) or that are firmly attached to the vegetation, e.g. Lepidopteran larvae. They will also probably under-record species living low down in tall vegetation, and species that can take action when they sense the noisy sampler approaching (Ausden, 1996).

#### 4.3.3.3. Direct counting

Direct counting or searching is a simple method though requires a good understanding of a species habitat or microhabitat. Timed searches are of more frequent use in aquatic habitats and have been used to make quick assessments of the invertebrate faunas of ponds. Hill et al (1992) used the number of individuals counted in a set period of time to obtain relative estimates of conspicuous taxa such as butterflies at different heights in a rainforest canopy. Pond Action (1989) suggest searching a small (<1 ha) pond for a total of three minutes, using hands and a net, searching each habitat within the pond for a period of time in proportion to its area. Counts can also be based on the number of individuals per unit vegetation (Ausden, 1996). The sizes of samples can be standardized by either a) counting the number of leaves or buds per sample, after they have been checked for invertebrates or, b) weighing the shoots or foliage. The first method is more suitable for plants with well-defined leaves, and the second for those with small or ill-defined leaves. Conspicuous invertebrates can also be counted as number of individuals per unit area e.g. quadrat for immobile taxa, or box quadrat (quadrat with high sides) for mobile taxa. The quadrat should be surrounded by a Perspex shield before counting begins to prevent individuals escaping. Coleman et al. (1998) recommend hand sorting a known area as a standard method for quantifying surface macro-arthropod densities on a per unit area basis (Edwards, 1991) of 1 m<sup>2</sup> rather than pitfall trapping. This method is more difficult when the vegetation is tall and/or dense but could, for example, be of use on ground where bare peat is revegetating (Stoneman & Brooks, 1997). Also,

transects have been used to monitor butterflies (Pollard, 1977 and Thomas, 1983), dragonflies and damselflies (e.g. Moore & Corbet, 1990; Brooks, 1993). For less conspicuous invertebrates dwelling within vegetation, sweep-netting, beating and suction sampling are useful techniques (see below). Invertebrates can also be extracted from vegetation, soil and air using a variety of other apparatus including extraction funnels, sieves, pooters and heating trays (Stoneman & Brooks, 1997).

Direct searching is a quick and easy investigation of habitats and microhabitats and has the advantage of being selective compared with trapping methods. Some methods allow individuals to be released unharmed. Disadvantages are that it is less efficient in terms of numbers caught per time spent in the field compared to trapping methods; it requires identification knowledge, removal of vegetation which is destructive, and can be time consuming. It is usually biased towards locating obvious, active and large species. Disturbance during searches may result in underestimation of some species numbers (see Ausden, 1996). The greatest diversity of invertebrates are often found within marginal habitats (lag, fens, scrub and so on) which, though interesting, may not be representative of the whole site (Stoneman & Brooks, 1997).

#### *4.3.3.3.1. Sweep netting*

This method involves passing a sweep net through the vegetation using alternate backhand and forehand strokes. After a series of sweeps, invertebrates caught in the net can be encouraged to move to the closed top of the net by holding this end up towards the light.

Sweep netting is a quick, low-cost, and efficient way of collecting large numbers of invertebrates. However, sweep netting cannot be carried out if the vegetation is damp and does not work well in vegetation less than 15 cm high, or which has been flattened by wind, rain, or trampling. Coulson & Butterfield (1985) reported that the frequent and high rainfall in upland areas is a major problem. They stated that this method only gave consistent results when the vegetation was dry but there were many days in the year when it was not possible to use them efficiently. It is of more limited value for purposes of comparison monitoring, because of variations in the efficiency of sweep netting in differently structured vegetation. The catch will also be influenced by the speed, depth and angle at which the net is pulled through the vegetation. Hence, in order for comparisons to be made, the mode of sweep netting should be standardised - each sample consists of a series of net sweeps of approximately 1 m in length taken every other pace while walking at a steady speed through the vegetation (Ausden, 1996).

#### *4.3.3.3.2 Beating*

Beating is a simple technique involves sharply tapping branches with a stick and catching dislodged invertebrates in a beating tray held beneath. It is quick and easy, and can be used to produce relative estimates of invertebrate numbers. It is biased towards species that are easily dislodged but which do not fly when disturbed. Clearly, this is only suitable with specific peatland habitats consisting of appropriate vegetation that also supports invertebrates.

#### *4.3.3.3.4. Plankton netting*

Fine-meshed plankton nets can reveal a high diversity and abundance of small, open water, largely transparent, crustacean species. These species range from tiny water fleas and copepods through to

quite large predatory species such as *Leptodora* and *Bythotrephes*. This technique is obviously restricted to peatland habitats with standing water.

#### 4.3.3.3.5. Extraction from peat samples

Surface or peat-dwelling invertebrates can be collected in peat monoliths or cores and the invertebrates extracted in the lab from dry or wet peat. Microfauna (e.g. protozoa), and mesofauna (e.g. Rotifers, Tardigrades, Nematodes, Enchytraids) can be extracted from soil and peat by techniques described in more detail in Coleman et al. (1998). Soil animals play an important role in ecosystem element cycling. By 'pre-digesting' large amounts of detritus they facilitate further decomposition of the substrate by soil microbes (e.g. Standen, 1978). On peatland sites, the hydrological component of the habitat is often regulating the abundance of soil fauna: the higher the water level, the smaller the soil fauna populations (Kozlovskaja, 1974; Standen and Latter, 1977; Markkula, 1981; 1982; Vilkkamaa, 1981). Also, on pristine mires the litter material is often mostly Sphagnum moss remains that are of low quality from the soil invertebrate viewpoint (Smirnov, 1961; Latter and Howson, 1978). Thus these invertebrates may be important indicators of habitat and site restoration success. Enchytraid worms, for example, have been determined using the wet funnel method of O'Connor (1962) and numbers were found to relate to both temperature and DOC in upland blanket bog (Cole et al. 2002). Recently, Carrera et al. (2009) have shown that enchytraeids are a crucial control on peatland C fluxes in response to warming. They may therefore be relevant to peatland restoration relative to potential impacts of climate change. Also, van Dijk (in press) determined soil community composition in restored peat meadows with different groundwater levels and soil pH. They found that Community composition of microorganisms, Collembola and Enchytraeidae differed considerably between meadows and were correlated with differences in groundwater levels and soil pH. Collembolan and enchytraeid species from wet and neutral environments were more abundant at meadows with higher groundwater levels. Lower fungal to bacterial PLFA ratios and higher numbers of protozoa indicated an increased importance of the bacterial part of the food web at meadows with higher groundwater levels. Food web model calculations suggested that the observed changes in community composition would lead to higher rates of C and N mineralization at meadows with high groundwater levels. They concluded that understanding changes in soil community composition in response to specific restoration measures may help us to better understand ecosystem responses to wetland restoration schemes, especially regarding soil biogeochemical processes. For information on restoration measures to rehabilitate microinvertebrates in raised bogs see Van Duinen et al. (2004).

Rotifers, like nematodes, are aquatic animals (inhabiting soil water films). Francez (1981) identified 142 species in various peatlands of Auvergne (France). In addition, he observed that the abundance and average size of these organisms was higher in fens ( $8.2 \times 10^4$  ind.  $m^{-2}$ ) than bogs ( $2.9 \times 10^4$  ind.  $m^{-2}$ ). This trend is probably related to differences in moisture content and pH (Francez, 1987). It is best to sample the top few centimetres of peat for rotifers as this is their habitat as well as in mosses (Coleman et al. 1998). Samples should not be dried because it is best to have live specimens for identification. Rotifers are extracted using centrifugation as for nematodes below. Vegetation can be agitated in water and the suspension washed through a sieve, similar to sizes used for nematodes. A dissecting microscope at 400x magnification or higher is used for identifying living rotifers. The majority of identified rotifers are in one order, the Bdelloidea, and are characterized by the cirri, or "wheel(s)" on their anterior end. Francez (1981, 1987, 1988), and Bledzki & Ellison (2003) have established species lists for peatland rotifers (Gilbert & Mitchell. 2006).

Nematodes can be very abundant in *Sphagnum* and can have a significant impact on bacterial and fungal populations (Ingham et al., 1985; Gilbert & Mitchell, 2006). According to Wasilewska (1991) the relative abundance between bacterivorous and fungivorous nematodes on one side and phytophagous nematodes on the other is dependent on the moisture content of the environment. The abundance of nematodes is about  $10^5$  ind.  $m^{-2}$ ,  $1-200 \mu m g^{-1}$ , or  $40$  ind.  $MI^{-1}$  in peatlands (Gilbert & Mitchell, 2006). The choice of extraction method varies with knowledge of the soil type and the nematode species, but in general nematologists recommend elutriation, sugar centrifugation, sieving, or misting as priority techniques (Coleman et al. 1998). It is recommended that pilot studies are conducted in order to choose the better extraction method. Wasilewska (2006) determined changes in the structure of the soil nematode community over long-term secondary grassland succession in drained fen peat. Soil cores were collected measuring  $2 \text{ cm}^2$  in surface area and  $50 \text{ cm}^3$  in volume and nematodes were extracted by a modified Baermann funnel technique (Freckman & Baldwin, 1990; McSorley, 1987). Guidelines established for plant parasitic nematodes by the Society of Nematologists (Barker, 1978) recommend that the number of cores (core size =  $2.0 \text{ cm}$  diameter) to be composited into one sample should be 10 cores for plots  $<5 \text{ m}^2$ ; 20 cores for plots  $5-100 \text{ m}^2$ ; and 30 cores for plots  $>100 \text{ m}^2$ . The Baermann funnel method is a field technique that uses small samples (about  $100 \text{ cm}^3$  volume or  $40-50 \text{ g}$ ). The nematodes were heat killed, fixed in 4% formaldehyde, and identified to genus level, based mainly on Andr assy (1984) and Bongers (1988).

Desiccation funnels, such as the Tullgren funnel are used to extract invertebrates from a variety of loose, large particles substrates (see Murphy, 1962 and O'Connor, 1962). Enchytraeids are small Oligochaetes that can affect decomposition processes indirectly by comminution and mixing of organic material and soil, and by digesting soil microbes, releasing mineralized nutrients for subsequent plant uptake (van Vliet et al., 1995; Cole et al., 2002). In peatlands, enchytraeid worms represent up to 70% of the total peat fauna biomass and previous studies have highlighted their potential use as 'biological indicators' for functionally important changes in the C cycle (Carrera et al., 2009). Being small, segmented worms, distantly related to earthworms, enchytraeids are very sensitive to a lack of water and are therefore usually found in mesic to moist habitats. They are commonly sampled with  $5 \text{ cm}$  diameter corers, to a depth of  $5 \text{ cm}$ . The sample is placed on a sieve in a funnel filled with water in (a modified wet-funnel extractor (O'Connor, 1962)) and exposed to increasing heat and light. After 4 hours, the light intensity in 40 watt bulbs is gradually turned up on a rheostat timer until the surface reaches a temperature of  $45 \text{ }^\circ\text{C}$ . Enchytraeids respond by moving away from the heat and light and passing through the sieve into the water below. They are then counted and/or preserved in 70% ethanol. Silvan et al (2000) used wet and dry funnel extraction to assess numbers of Enchytraeidae, Collembola, Oribatida, Mesostigmata and Prostigmata in an 8-cm-deep surface peat layer compared among a pristine undrained pine mire site, comparable sites drained for forestry 12, 26 and 60 years earlier, and a 42-year-old drained site re-wetted two years earlier. In the course of the drainage succession, the soil fauna community structure became more similar to that of upland sites with similar tree-stand growth potential. They also note that in general,  $>80\%$  of Collembola, Oribatida, Mesostigmata and Prostigmata, and  $>60\%$  of Enchytraeidae were found in the topmost 4-cm layer. Desiccation funnels are not labour-intensive, since sorting can be left unattended. However, small invertebrates are likely to be missed during sieving. The catch will be affected by the size of the funnel.



#### 4.3.3.4. Conclusions

The techniques used will depend on the peatland type: upland or lowland, due to differences in habitat, and therefore depend on knowledge of autecology. The choice to monitor invertebrates will depend on the status of the restoration site (i.e. SSSI) and also on whether invertebrate indicators are deemed important for indicating restoration success. Spiders may be a particularly good indicators of total invertebrate mesofauna and therefore useful for determining habitat changes in peatland restoration. Enchytraeids and nematodes may be useful indicators for functionally important changes in the C cycle. Grouping of species by habitat preference may be a useful technique for assessing habitat disturbance and hence peatland restoration.

A sampling period over at least one or two years is needed to accommodate the different phenologies, and a variety of collecting methods are needed to sample the various faunistic elements. Pitfall traps are the main techniques used in the study of the terrestrial arthropod fauna in peatlands, and special techniques are required for sampling the aquatic habitats encountered in bogs. Even if such detailed sampling is possible, sorting of such sampling is time consuming, expensive and requires specialized knowledge. Further, cooperation of numerous taxonomic experts is essential for accurate species identification in most groups.

#### 4.3.4. Microorganisms

##### 4.3.4.1. Introduction

Microorganisms perform essential ecosystem functions in peatlands particularly in respect to decomposition, water quality, mineralisation for plant productivity and greenhouse gas production in all types of peatlands. Thus monitoring changes in microorganisms or microbial community structure and function may serve as criteria for monitoring the success of peatland restoration (Anderson et al., 2006; Erhenfield, 2001). Recent research on regenerating cutover peatlands has shown the potential of a variety of microbiological techniques to indicate restoration success (Artz et al., 2008; Laggoun-Défarge et al., 2008; Anderson et al., 2006). While establishment of vegetation is the most easily visible indicator of regeneration on cutover peatland, the reinstatement of belowground functions is less well understood. Vegetation succession results in differences in peat quality in terms of C availability. The respiratory response of the soil microbial community to ecologically relevant substrates (community-level physiological profile, CLPP) such as those found in rhizosphere exudates and litter hydrolysates, is thought to reflect the activity and functional diversity of the soil microbial community, especially those involved in turnover of soluble photosynthate-derived C. Artz et al. (2008) investigated the relationship between CLPP and typical regeneration stages at five European peatlands, each with up to five sites representing a gradient of natural regeneration stages. They found that functional microbial diversity in a regenerating cutover peatland responded to vegetation succession. The strength of the effect probably depended on quantities of labile C allocation to the soil microbial community. Therefore, particularly in the early stages of regeneration of cutover peatlands, CLPP could provide vital information about the relative importance of different plant functional types on potential rates of labile C turnover.

Laggoun-Défarge et al. (2008) investigated the bioindicator value of organic matter, testate amoebae (protozoa) and bacteria in peat from two regenerating stages and a reference site of a cutover bog. Surface testate amoeba communities changed from recent to advanced stages of regeneration, indicating a shift from wet and moderately acidic conditions to drier and more acidic conditions. Over the regeneration sequence (1) the biomass and average size of species declined but were higher at the unexploited site and (2) species richness and diversity increased but density declined. Although secondary succession in the cutover bog led to an ecosystem similar to that of the reference site in terms of surface vegetation, organic matter and testate amoebae continued to reflect disturbance associated with peat harvesting. Nevertheless, the described dynamics of both microbial and biochemical variables over the succession showed similarities between the advanced stage and the reference site: a higher testate amoeba diversity was associated with better carbohydrate preservation and a more heterogeneous botanical composition of the peat. The inferred water table depth and pH based on testate amoebae indicators proved to be an alternative approach for assessing restoration processes, in contrast to labour-intensive repeated measurements in the field. The botanical and biochemical composition of peat organic matter provided additional information on past anthropogenic perturbations of the bog and could be used for restoration monitoring. The combination of several indicators therefore provides a more complete assessment of ecological conditions that could be valuable for the management of cut-over peatlands.

Anderson et al. (2006) measured a variety of physicochemical parameters to evaluate the success of restoration of a *Sphagnum* peatland. Restoration work included not only the blockage of drainage ditches, but also the reintroduction of plant material including *Sphagnum* remains. Microbial biomass values derived from the chloroform fumigation extraction technique (CFE) followed a gradient natural > restored > cutover through the profile, which was not the case with the substrate induced respiration (SIR) technique. Values from SIR varied overall between 0.19 and 4.88 mg C g<sup>-1</sup> and were significantly higher in the natural site. Overall, the results confirmed the existence of a lag between

the positive response of vegetation to restoration and that of the microbial compartment. This study also pointed out that some physicochemical dysfunctions remained even after three growing seasons following restoration in the subsurface horizons studied.

These techniques are expensive, time consuming and require detailed specialist knowledge as well as suitable laboratory equipment. Thus they are probably beyond the scope of most restoration projects unless research is conducted with a university. However, these techniques clearly show potential for future monitoring of peatland restoration success by observing differences in microbial communities between restored and referenced sites, or by following trajectories over time in relation to a range of other biotic and abiotic factors.

#### 4.3.4.2. Sampling

Since the microbial community is highly responsive to climatic and environmental change, it is recommended that samples are analyzed at least seasonally, although monthly sampling would be preferable to account for seasonal variation in a variety of interacting factors i.e. pH, DOC, temperature, hydrology, nutrients. Peat samples can be collected as with other soil core sampling such as those used for bulk density measurements, etc. Although accurate coring methods are not required for microbial sampling, they are recommended to avoid contamination of samples. Biota are very site-specific and change during the season, and therefore a recognition of the importance of compositing, replication, and recognition of site variability are most important and must be incorporated into the sampling design (Paul et al. 1998). Peat samples should be stored in bags that retain moisture and prevent oxygenation (thin polyethylene), and should be placed in a temperature-controlled environment immediately upon sampling. A portable cooler has been found satisfactory for transportation. Immediate processing, although desirable, is often not possible. Overnight storage at field temperature is often used or 5 °C. The recognition that a delay in processing of field samples is often impossible to avoid has led Joergensen (1995) to recommend that all samples be preincubated for 5-7 days under laboratory conditions before analysis to attenuate some of the disturbance associated with sampling. However this technique does not allow measurement of dynamic situations and microbial conditions in the sample may reflect the storage/incubation more than the field conditions.

Sieving through 2 mm mesh using the back of a spoon removes plant debris and large solids and provides mixing to decrease sample heterogeneity. Small samples (20 g) are attractive because of economy in containers, extractant volumes, and overall sample handling capacity, but they increase sample variance compared with larger samples. Fifty gram samples obtained from well-mixed composite sub-samples are recommended as a compromise (Paul et al. 1998).

#### 4.3.4.3. Microscopy

Descriptions of microbial community structure and function have been largely based upon measures of species composition using isolate-based methods. Fluorescence microscopes combined with a skilled observer or image analysis software can differentiate between biota and particles in peat. Paul et al. (1998) detail a number of staining techniques for bacteria and fungi plate counts, with preparation of peat samples described by Lopez-Buendia (1998).

This approach has been shown to underestimate diversity, since less than 10 % of the total microflora observed in microscopy is isolated (Brock, 1987). Sorheim et al. (1989) concluded that

there was no direct correlation between plate isolation and bacterial diversity. Measures of microbial diversity rely not only on the types of organisms present but also on their relative abundance (Paul et al. 1998). The latter has rarely been accurately determined. Thus microscopy may be relatively straight forward as a technique compared to the more complex community based techniques below, but does not offer much insight into functional microbial ecology that is critical in restoration ecology.

#### 4.3.4.4. Testate amoeba

Testate amoebae (Protozoa: Rhizopoda) are unicellular shelled animals which live in abundance on the surface of most peat bogs. These protozoa have tests made of smooth secreted material, pre-formed plates or cemented particles which are gathered from the surrounding environment. Such particles can include small pieces of silica, pollen grains, fungal hyphae and other organic detritus (Charman et al., 2000).

Testate amoebae are now widely used in palaeoecological research to reconstruct hydrological changes in peatlands as they respond mainly to factors such as water table level and soil moisture (Hendon et al., 2001). Recent studies of the modern ecology of testate amoebae have enabled the development of transfer functions designed to quantify the relationship between testate amoebae assemblages and fluctuations in peatland water tables and soil moisture. The resultant records of past changes in water tables have been widely used on European raised bogs in particular to infer palaeoclimatic change. Details of this method are provided in Charman et al. (2000).

Laggoun-Defarge et al. (2008) assessed the bioindicator value of organic matter (OM), testate amoebae and bacteria in peat from two regeneration stages and a reference site of a cut-over bog. They extracted testate amoebae from peat samples by sieving through 20  $\mu\text{m}$  and 300  $\mu\text{m}$  meshes without boiling (Hendon & Charman, 1997). Both living and dead shells were identified and counted under a microscope at 200 $\times$  and 400 $\times$  magnifications. Biovolumes of each living (active and encysted) species were estimated by assuming geometrical shapes and were converted to carbon using the conversion factor  $1 \mu\text{m}^3 = 1.1 \cdot 10^{-7} \mu\text{g C}$  (Weisse *et al.* 1990). Nomenclature for testate amoebae followed Meisterfeld (2000a,b).

#### 4.3.4.5. Chloroform fumigation

Chloroform fumigation of peat kills most organisms and destroys their membranes and cell walls. The released labile C is consumed and respired by surviving microbes. Fumigation is combined with incubation to release the C as  $\text{CO}_2$  and the N as  $\text{NH}_4^+$ , or alternatively, fumigation can be followed by extraction of the cell constituents. From the C and N, an estimate of microbial biomass can be calculated. Information on available methods and comparisons with other methods can be found in Paul et al. (1998); Kaiser et al. (1992); Martens (1995); and Joergensen (1995). Williams & Silcock (2000) provide a method for determining microbial biomass in peat by fumigation extraction using the flush of DOC.

#### 4.3.4.6. Substrate-induced respiration

Substrate-induced respiration is based on the principle that, under standardized conditions, the metabolism of glucose added in excess is limited by the amount of active microorganisms in soil

(Bloem et al. 2005). During the first hours after substrate addition there is no significant growth of the microbial populations, and the respiratory response is proportional to the amount of microbial biomass in the soil. Anderson & Domsch (1978) established a conversion factor by correlating the substrate-induced respiration with the microbial biomass determined by the fumigation-incubation method: 1 ml CO<sub>2</sub>/hour corresponded to 40 mg microbial biomass carbon. Of the numerous methods for measuring microbial biomass in soils, the substrate-induced respiration (SIR) method has the following advantages: (1) it is relatively simple and rapid; (2) it identifies a physiologically active component of the microbial biomass; and (3) when used with selective inhibitors, it allows for separation of prokaryotic and eukaryotic contributions to the total physiological response (Beare et al. 1991). Methods are available in Bloem et al. (2005) and also in Williams & Silcock (2000) who determined microbial C in raised bog peat using substrate-induced respiration, Fisk et al. (2003) in northern peatlands, and Artz et al. (2006).

#### 4.3.4.7. Community-level physiological profile (CLLP)

This method involves the direct inoculation of samples into Biolog<sup>®</sup> microtiter plates (containing different C sources, nutrients, and a redox dye), incubation, and spectrometric detection of heterotrophic microbial activity (Insam & Goberna, 2004). The method was originally developed (Bochner, 1989) for medical strain identification, and has only later been adapted for use with inocula from extracted microorganisms from environmental samples (Garland & Mills, 1991). Its simplicity and speed of analysis are attractive to the microbial ecologist, but the technique requires careful data acquisition, analysis, and interpretation (Insam & Goberna, 2004).

Artz et al. (2008) determined CLLP using the MicroResp assay, which differs from the commonly used Biolog technique in that it is less dependent on growth of soil microorganisms, instead quantifying the mineralisation of C substrate additions to the soil community (Campbell et al. 2003). Samples were weighted into microtitre plates. Radiolabelled carbon sources were added and the plates were sealed and the evolved <sup>14</sup>CO<sub>2</sub> captured on rolled filter papers and analyzed. Artz et al. (2008) stated that “although definitive proof of restoration success will always be measured by how closely a restored site resembles an intact peatland in terms of vegetation, hydrological conditions and net carbon balance, this is costly in man-hours, equipment and analysis. The observed concurrence of CLPPs with regeneration stages, which run along a gradient of increasing C sink strength, indicate that it may be possible to identify features of labile C turnover that indicate a return to an actively C-fixing state. In summary, determination of CLPP may help to focus restorative efforts in peatlands in a way that considers more than just the above-ground habitat.”

#### 4.3.4.8. Phospholipid fatty acid analysis

Phospholipid fatty acids are major constituents of the membranes of all living cells, and different groups of microorganisms synthesize different varieties of PLFA through different biochemical pathways. Thus, some PLFAs can be used as “bio-signatures” to analyse changes in microbial biomass and microbial community structure. For example, results from field studies have shown that microbial communities under differing agricultural management profiles can be distinguished using a simplified extraction of cellular fatty acid methyl esters (Cavigelli et al. 1995). Disadvantages of this method are that it is the most resource intensive of the phenotypic methods described (Sinsabaugh et al. 1998) and requires analysis via high resolution capillary gas chromatography. However, the techniques are rapid and can be run for a large number of samples. Van Dijk et al. (2009) determined soil community composition after peat meadow restoration using PLFA and concluded that

understanding changes in soil community composition in response to specific restoration measures may help us to better understand ecosystem responses to wetland restoration schemes, especially regarding soil biogeochemical processes. General methods are available in Sinsabaugh et al. (1998), and Dickens & Anderson (1999) for bog and forest soil, and Van Dijk et al. (2009) for peat meadows.

#### 4.3.4.9. Extracellular enzyme activities

Enzyme assays provide functional information about the microbial biomass, although activity cannot be related to specific microbial genera and may reflect the persistence of extant enzymes in peat. Extracellular enzymes are produced by bacteria and fungi in peat at an expense to breakdown high molecular weight organic matter into assimilable forms. The rate of generation of utilizable substrates in peatlands for these enzymes therefore limits microbial metabolism and hence decomposition. By quantifying the potential activity of these enzymes, it is possible to make inferences about the relative effort directed by microorganisms toward obtaining carbon, nitrogen, or phosphorus from specific sources. Freeman et al (2001) and Burns & Dick (2002) provide recent evidence for important enzyme mediated feedback processes in peatlands and soils. Important enzyme activities are hydrolases (e.g. cellobiohydrolase,  $\beta$ - $\beta$ -glucosidase, sulphatase, phosphatase) and oxidases (e.g. phenol oxidase) that can be determined by adding a known concentration of artificial substrates to peat and incubating for a specific length of time. Some artificial substrates fluoresce upon cleavage (e.g. methylumbelliferone) or the product formed absorbs light and is measured on a spectrophotometer (e.g. L-DOPA). The fluorogenic substrates are more sensitive by at least an order of magnitude than chromogenic substrates such as p-nitrophenyl, although these substrates can be easier to work with because of their greater aqueous solubility and because humic substances often exert severe quenching effects on fluorescence. However, the methylumbelliferone substrates have been used successfully by a number of authors in peatland ecosystems (i.e. Freeman et al., 2001; Kang & Freeman, 1999).

Assays for enzymes in peat are relatively simple. The difficulties lie in choosing assay conditions and in interpreting results. The basic decision is whether to measure activities under conditions as close as possible to field conditions or whether to make standardized comparisons among samples (i.e. temperature, pH). It is recommended that conditions are kept as close to field conditions to take account of seasonal variation in physicochemical parameters, especially pH, that have a very great effect on enzyme activities. The amount of artificial substrate added must be determined from preliminary kinetic analyses based on Michaelis-Menten kinetics. In this, the concentration of substrate that achieves the maximum rate of enzyme reaction (i.e. saturation of the enzyme-substrate complex) is the concentration used for determining the enzyme activity. Also note that enzyme activities can be remarkably low in peatlands especially upland blanket bogs and therefore optimization of methods is critical. Also, recalcitrant dissolved organic matter (e.g. phenolics and humic acids) can interfere with both enzyme activities and the fluorometric assay and therefore a number of carefully prepared blanks and controls are recommended. Details of enzyme methods and the issues involved are provided in Burns & Dick (2002), Sinsabaugh et al. (1998), Freeman (2001), and Kang & Freeman (1999).

#### 4.3.4.10. Nucleic acid analysis

Nucleic acid analysis provides information on the structural composition of the microbial community (see Sinsabaugh et al. 1998). A variety of techniques can be used to assess diversity within a sample, to compare similarities among samples, or to estimate the relative abundance of specific taxa. In

general, these methods are more fastidious than phenotypic methods and require more specialized equipment and training.

The most critical step for most molecular or nucleic acid techniques remains the isolation of DNA or RNA from soil/peat and its separation from other materials. Sinsabaugh et al. (1998), Schneegurt et al. (2003), Zhou et al. (1996), Jerman et al. (2009), Zadorina et al. (2009) and Nercessian et al. (1999) provided detailed discussion and methodology for extracting and analysing DNA from soils and peat.

#### 4.3.4.11. Conclusions

Recent published research suggests that microbiological techniques may be particularly useful for evaluating restoration success in peatlands. However, these techniques are time consuming and expensive to perform routinely due to equipment and staff training. However, this may be possible via collaboration with academic research groups which is highly recommended. Significant replication with monthly sampling are recommended to account for seasonal variation in interacting factors. Techniques such as extracellular enzymes may be of more ecological relevance than bacterial counts/microbial biomass alone, although trajectory analysis of microbial biomass has proven useful in some studies. Assessments based on PLFA, CLLP and/or DNA analysis combined with enzyme substrate utilisation profiles would ideally provide substantial scientific benefits.

## 4.4. Hydrology

### 4.4.1. Introduction

This section details the monitoring of hydrological processes, which are fundamental to the existence and restoration of peatlands. Water levels and water level fluctuations play a major role in mire ecosystems. Too high water levels may reduce plant productivity, which negatively impacts on peat formation (Joosten, 1993; Couwenberg & Joosten, 1999). Too low water levels may encourage plant productivity, but also impede peat accumulation by enhancing aerobic decay (Clymo, 1984). A good understanding of hydrology is therefore fundamental to understanding how to restore peatlands.

Understanding the hydrology of a site can also be important for restoration objectives that are not directly related to hydrology. For example, the trapping and transformations of nutrients and pollutants are common aims of peatland restoration (Trepel et al. 2000; Schumann & Joosten, 2008). To evaluate the success of the restoration, mass balances have to be calculated which will mean linking hydrology to soil/water chemistry (i.e. physicochemistry). This may be achieved by determining the differences in concentration of substances of interest and volume of water flowing in and out of the peatland (see Davidsson et al. 2000).

Ideally, to fully understand the hydrology of a peatland site, sufficient hydrological parameters should be monitored to establish a water balance for the site, including precipitation, evapotranspiration, groundwater inflow and outflow, surface water inflow and outflow and water storage. In practice, resource constraints are likely to be such that not all of these hydrological processes can be monitored. Indeed, depending on the restoration objectives, it may not be necessary to monitor all of these processes. For example, if the restoration objectives relate to reestablishment of natural water level regimes then it may be sufficient to monitor only water levels. However, if the restoration method fails to achieve the desired objectives then data for other hydrological processes may help to establish the reasons. The following sections outline the key methods for monitoring different hydrological processes.

### 4.4.2. Dip wells

Dip wells are used to monitor fluctuations in the water table. Fluctuations in water levels reflect the overall water balance of the site (Bragg, 2002) and are an indicator of water storage. Given the influence of water level on the peatland ecosystem water level is a key hydrological parameter to monitor. To construct a dipwell a hole is augered into the peat and, if necessary any underlying soil strata, with a hand auger. If the peat overlies a confining layer (e.g. clay) then the dipwell should not penetrate the confining layer. The hole is then lined with perforated PVC pipe that is sleeved in a geotextile or, if this is unavailable, other durable fabric with a loose weave, to prevent the ingress of peat that may block the perforations in the well (see Floodplain Meadows Partnership (undated) and Stoneman & Brooks 1997). In areas where the pipe could pose a hazard or be unsightly it should be inserted so that its top is 3cm below the ground surface. In other cases it can protrude above the ground surface (e.g. Bragg et al 1994). Perforations in the pipe can be made by drilling holes or with horizontal sawcuts spaced along the full length of the pipe, except for the top 10cm. The geotextile sleeve covering the pipe prevents debris blocking the holes. An example of a dipwell design is provided in Fig. 11.



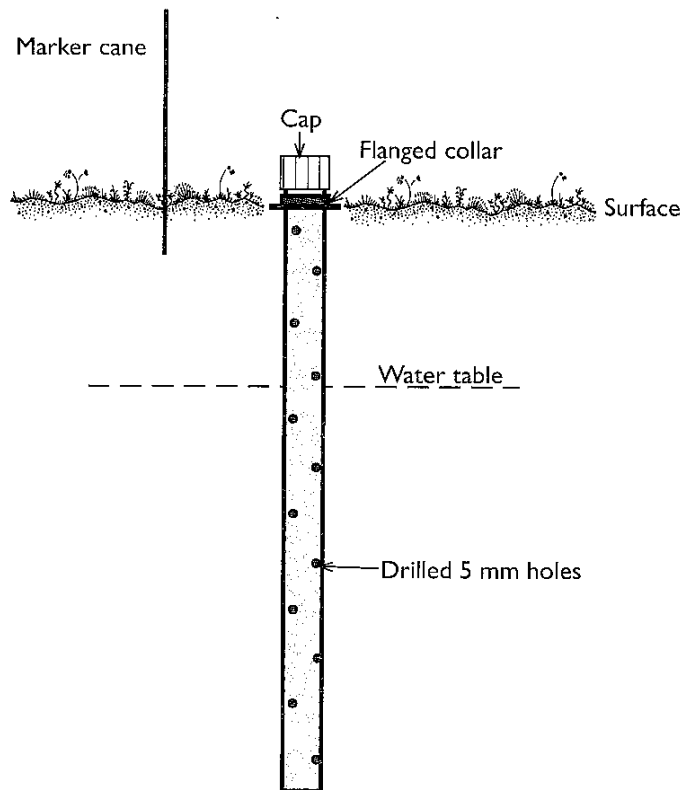

**Figure 11** A design for a dipwell with a flanged collar. The cap aids visibility as well as keeping out snow, mice and insects (Stoneman & Brooks, 1997).

Typical diameters for dipwells are 5-10 cm. If the peat is fairly well consolidated then it may be possible to insert a pipe the same diameter as the augered hole. If the peat is prone to collapsing when the auger is withdrawn then it may be necessary to auger a hole larger than the pipe and backfill the space with coarse sand once the dipwell has been inserted. The top of the well surrounding the pipe should be sealed with clay to prevent surface flow from entering the well, which could give inaccurately high measurements for water table levels.

In areas that are grazed it is important to prevent stock from stepping into the well and this can be prevented by covering the opening of the well with a galvanized plate secured to the ground with tent pegs. This also facilitates locating the wells on subsequent visits, in grazed or ungrazed areas, and prevents debris from entering the well.

For shorter monitoring period and in firmer peat conditions it may not be necessary to line the dipwell. A small (ca. 10 – 15 cm) length of pipe inserted into the well so that it is 3cm below the ground surface may be sufficient to maintain the well structure.

The depth of the well should be sufficient to allow measurement of the full range of fluctuations in the water table. The water table during dry periods may be below the bottom of the dip well if it is too shallow.

Measurements are typically made with a probe that sounds a buzzer on contact with water. The cable of the probe is graduated so the distance from the surface of the water in the well to the ground surface can be read once the probe touches the water. The relative elevations of the water table monitored in each of the dipwells can provide important information about the hydrology of

the site e.g. the flow direction and flow volumes within the peat. Surveying the relative levels of the ground surface at the dipwells can provide this information. If required, the elevation of the dipwells relative to an Ordnance Survey datum can also be established by surveying.

The number of dipwells to be installed will depend on the complexity of the hydrology (e.g. the number of drains or channels), the monitoring objectives and the size of the project area. At least three monitoring points arranged in a triangle will be necessary to establish the flow direction within the peat (Environment Agency, 2003). Establishing a transect of dipwells in the direction of flow can then be used to create a two-dimensional profile of the water table (Gilvear and Bradley, 2000). If there is a watercourse in the site then a transect of dipwells perpendicular to the watercourse will provide information on the form of the water table at the site. The resources available to monitor the dipwells will also be a consideration in the number installed. Typically, 10-15 dipwells are used in restoration projects with moderately simple hydrology. Hollis and Thompson (1998) suggest as a general principle wetland monitoring, one dipwell in the middle of 'a parcel of land', which can be interpreted as an area bounded by drainage ditches or other hydrological controls.

Once the water level in the dipwell has equilibrated, measurements can be taken. The appropriate frequency of monitoring will depend on the fluctuations in the water table. Where there is little change in the water table level monthly readings may be sufficient. Until the degree of fluctuation is established measuring the depth to water at weekly or two-weekly intervals is recommended (Schumann & Joosten, 2008). Automatic logging of the water levels is also possible using pressure transducers and electronic data loggers or analogue recorders with floats. A simple and cost-effective method for recording maximum and minimum water levels, a WATER Level RAin Gauge (WALRAG) has been described by Bragg et al. (1994).

The principal advantage of dipwells over other techniques for monitoring water table levels is that they are quick to install using cheap and readily available materials and even small number of dipwells can reveal a great deal about the hydrology of a site. A potential disadvantage when installing dipwells in peat is movement of the surface, for example due to changes in moisture content or trampling, resulting in inaccurate readings (Gilvear and Bradley, 2000). This inaccuracy can be minimized by measuring the elevation of the dipwells relative to a fixed datum (e.g. post driven through the full depth of peat to the mineral substrate). However, this inaccuracy may not be relevant if the parameter of interest is the elevation of the water table relative to the surface of the peat. Even without surface movement, manual measurements of water levels in dipwells are not always sufficiently accurate to determine water surface slopes in relatively flat areas. Automatic electronic data logging can overcome some of these inaccuracies, and provide increased precision, but greatly increase the cost of monitoring, the potential for theft or vandalism, and the initial setup of data logging systems can be difficult. Physical swelling groundwater effects and lunar cycle can alter water levels by 30 cm were mentioned at a meeting of experts at an NE workshop (Appendix 3). The periodicity of the dipwell/piezometer readings is therefore very important and should be related to the lunar cycle. Further information on dipwell installation and operation can be found in Stoneman & Brooks (1997) and Floodplain Meadows Partnership (undated).

#### 4.4.3. Piezometers

Piezometers are used to measure *hydraulic head* (water pressure) rather than water levels and can also be used to calculate hydraulic conductivity. Water flow dynamics (e.g. groundwater flow patterns) within the peatland depend on both the hydraulic conductivity as well as on hydraulic heads of different peat layers (see Davidsson et al. 2000). The hydraulic conductivity is mainly determined by pore size, but also by pore shape and the connection between the pores and is a

function of peat type, texture and degree of decomposition (Ivanov, 1981; Rizutti et al. 2004). Van der Schaaf (1999) describes different (field) piezometer methods (e.g. rising or falling head method, pit bailing method) to measure and calculate hydraulic conductivities. However, the properties of peat (e.g. compressibility and changes in properties due to drying out) make calculation of hydraulic conductivity in peat more complex than for soils. Holden and Burt (2003) discuss these issues in more detail.

In contrast to dipwells, piezometers are sealed along their entire length with only a short open and screened section at bottom of the pipe (see Van der Schaaf, 1999; Davidsson et al. 2000). They are typically installed in groups or *nests* with different piezometers installed to different depths so that they provide a reading of hydraulic head at different levels. Information from a nest of piezometers can be used to determine vertical flows of water i.e. whether the peat is recharging an underlying aquifer or is water is being discharged from the aquifer to the peat. Multiple nests of piezometers can be used to establish horizontal flows of water within a peatland.

In contrast to dipwells, piezometers are relatively complicated to install but provide more information on groundwater flow directions and rates. If the data are intended to be used for hydrological modelling or for hydrological investigations of peatlands, e.g. to establish sources and rates of groundwater inflows to fens, then data from piezometers are likely to be more useful. However, in situations where there is high hydraulic conductivity and no confining layers, as is mostly the case in peatlands, dipwells can provide sufficient information for monitoring purposes. Piezometers can also be useful when water chemistry is being monitored as they allow water samples to be taken from different levels, whereas water samples from dipwells are a mixed sample from the full depth of the saturated zone into which the well penetrates.

As with dipwells, automatic logging of data from piezometers can increase the frequency, precision and accuracy with which data can be collected but costs are higher and the initial setup will require more time. Further information can be found in Environment Agency (2003) and Domenico & Schwartz (1990).

Piezometers can be used to calculate values of hydraulic conductivity of peat but, as hydraulic conductivity is highly spatially variable, a number of measurements would be required to establish an average value with confidence. Measurements are typically taken by adding or removing water from the piezometer and monitoring the recovery of the water level to its original state. The rate of recovery can be used to determine the hydraulic conductivity. However, the compressible nature of peat makes the calculation more difficult than for mineral soils (Holden and Burt 2003). Commercial software packages and some free spreadsheet tools are available to enable the calculation of hydraulic conductivity but these are developed for hydrogeological applications and may not be suitable for application to peat.

If there are sufficient piezometers to determine the hydraulic head contours for the site then a flow net analysis can be conducted to determine direction of flow (horizontally and vertically) within the peat and, in conjunction with estimates of hydraulic conductivity, the volume of flow through the peat. This approach does, however, greatly simplify the anisotropy and heterogeneity of peat (see Beckwith et al 2003).

#### 4.4.4. Channel flow

Restoration of peatlands can have a significant effect on the catchment hydrology (Bragg, 2002). The actual effect on stream flow is determined by the particular restoration technique applied and the location within the catchment. Grip-blocking and gully-blocking can increase the response time of the

catchment and attenuate flood peaks by reducing the water travel times (Lane et al. 2003). However, increasing the saturation of the peat by blocking grips and gullies can reduce the water storage capacity of the peat and increase peak discharges (Lane et al. 2003). The particular distribution of grips and gullies is a key factor in determining the actual response to blocking. Changes in vegetation cover will influence the water balance by changing evapotranspiration and infiltration rates (Bragg, 2001, Holden 2009). Monitoring surface water flow from the catchment can provide important information on the catchment scale effect of restoration and can complement water level data. Stream flow should be monitored at the outlet of the subcatchment that encompasses the restored area. In some cases peatlands, because of their location, can affect the flow in more than one catchment (Bragg, 2002) and this should be accounted for where it occurs. A monitoring point should be chosen below the peatland area where the channel is stable but not so far down the catchment that the stream flow is influenced by other sub-catchments that are not the subject of the restoration effort. It may be necessary to monitor stream flow at more than one location to satisfy these requirements.

Stream flow can be monitored by establishing a relationship between the level of the flow in the stream (stage) and the flow. A fixed transect is established perpendicular to the channel using survey markers or wooden pegs to allow the transect to be located on subsequent visits. To achieve the best results, the transect should be established at a riffle or other hydraulic control on a straight reach where the channel is as stable as possible (see Environment Canada (2001) and Shaw (2001) for a summary of requirements for siting a transect). The profile of the transect is surveyed relative to a fixed datum. The discharge of the stream under a wide range of flow conditions is established using the velocity-area method (see Shaw, 2001) and a relationship is established between the discharge and the stage. Once this relationship is established the discharge can be estimated by measuring the water level in the stream relative to the fixed datum, preferably with the use of a fixed stage board. Establishing a stage-discharge relationship using the velocity-area method can, however, be time consuming as the discharge must be measured on several occasions, including high flow events which can be unpredictable and pass rapidly in upland catchments, and therefore difficult to measure. This method also requires current meter to measure the velocity of the flow, which can be a large, but one-off, expense.

The reliability of the stage-discharge relationship can be significantly improved by the construction of weirs or flumes (see Shaw, 2001), but these can be costly to install. However, relatively simple thin plate weirs can be installed in channels with a peat substrate (e.g. Daniels et al., 2008). The relationship between the water level and discharge for flat plate weirs is pre-determined by engineering equations and it is therefore not necessary to establish a stage-discharge relationship using the velocity-area method. Correct sizing of the weir is important. If weirs are over-topped under high flows and water flows around the edges of the weir there is a risk of erosion.

As the flow level, particularly in upland and small catchments, can change rapidly, automatic recording is important to fully capture flood events. This is best achieved by the installation of pressure transducers connected to automatic data loggers (see Clark et al, 2008; Daniels et al., 2008). Alternatively, analogue float recorders can be used.

While a crucial part of establishing the water budget of a site, without monitoring additional components of the hydrological cycle the information provided by monitoring discharge alone may be limited. For instance, changes in discharge may be due to changes in precipitation, storage or evapotranspiration not necessarily related to the restoration techniques applied and unless these additional components are monitored and can be related to pre-restoration data it is difficult to establish causal mechanisms.

#### 4.4.5. Precipitation

Precipitation can be a particularly important, or in the case of ombrotrophic systems only, hydrological input to peatland ecosystems. Precipitation can be measured easily using rain gauges, either manually read or automatically logging (Fig. 12). If there is a weather station (e.g. Met Office station) close to the site these data may be used to establish long-term trends and seasonal patterns. However, precipitation can have significant spatial variation and data from nearby weather stations cannot necessarily be used directly within the water balance for a site. While using data from Met Office Stations does not require field measurements and its associated costs and effort, the data may have to be purchased.

Where peatland systems are relatively flat, one rain gauge is sufficient to monitor rain for the whole site. If the area of interest is large with a strong climatic gradient (e.g. due to elevation differences) then additional rain gauges are required (Gilvear and Bradley, 2000).

The effect of rainfall interception by vegetation should be taken into account, as it may account for up to 40% of precipitation in dense vegetation (Gilvear and Bradley, 2000) with typical annual interception losses for heather ranging from 16–19% (Nisbet 2005). However, interception is difficult to measure accurately, particularly in short vegetation, and is not typically monitored. The intercepted rainfall is lost as evaporation, as such, is included within estimates of evapotranspiration, which is considered in the following section.

While the cost of monitoring rainfall is low, particularly if cumulative totals are monitored weekly or less frequently with a manually read rain gauge, the accuracy of rainfall measurements can be low because of the high spatial variability of rainfall.

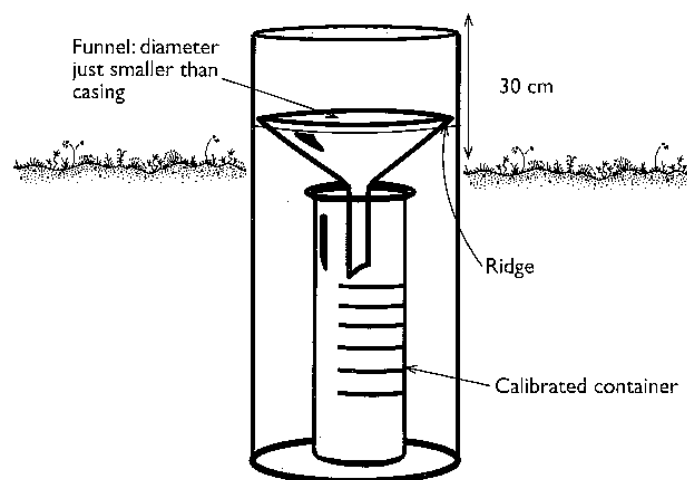

**Figure 12** A design for a simple collecting rain gauge (from Stoneman & Brooks, 1997).

#### 4.4.6. Evapotranspiration

Evapotranspiration is the combined loss of water to the air from evaporation and transpiration from vegetation. As the two processes are difficult to disaggregate they are typically considered together in measuring the water budget. Evapotranspiration losses to the water budget can be high in

peatlands because of the high water table and because the vegetation is not water-stressed and can transpire at near-maximum rates, given the constraints posed by meteorological conditions.

There are several factors that govern evapotranspiration losses:

- weather (air temperature, humidity, solar radiation, wind)
- vegetation type (e.g. vascular plants versus bryophytes)
- vegetation density
- soil cover (colour / albedo)
- growth stage

Evapotranspiration can be difficult to measure in the field and it is generally accomplished by the installation of automatic weather stations measuring air temperature, relative humidity, net radiation, wind speed and ground heat flux, although other methods are used. Rather than direct measurements, these data can be used to calculate evapotranspiration. Gilvear and Bradley (2000) summarise methods for estimating evapotranspiration and these are presented in Table 17.

**Table 17** Summary of methods for estimating evapotranspiration (adapted from Gilvear and Bradley, 2000).

<b>Direct measurement</b>	
Lysimeters	Actual evapotranspiration measured within isolated block by comparison with surrounding wetland. Percolated water in isolated block captured and evapotranspiration estimated by comparison with precipitation. Lysimeter is flush with ground surface so surface runoff is assumed to balance for the area of the lysimeter.
Ventilated chambers	Vegetation enclosed by chamber: enables variation in transpiration between vegetation types to be determined.
Water table patterns	Evapotranspiration determined from diurnal changes in water surface.
<b>Hydro-meteorology</b>	
Mass-transfer method	Uses bulk aerodynamic factor representing factors removing water vapour from evaporating surface.
Vapour flux method	Evapotranspiration related to removal of saturated layer (as mass-transfer method) but moisture flux determined by measurement at two points.
Bowen ratio method	Based on the energy available for evaporation and using the ratio of sensible and latent heat.
<b>Combination methods</b>	
Penman equation	Defines evapotranspiration as a function of radiation; saturation deficit; and wind run which are used to estimate evapotranspiration.
Priestly Taylor	Modification of Penman equation; uses the slope of the saturation vapour pressure curve.
Penman Monteith	Modification of Penman equation incorporating turbulent transfer and available energy.
<b>Regional estimate</b>	
Thornthwaite equation	Empirical relationship between monthly evapotranspiration and temperature. While there are no direct remote sensing techniques for evapotranspiration, remotely sensed data (e.g. soil moisture) from satellite data and Synthetic Aperture Radar (SAR) can be used to parameterise models and evaporation equations at approximately 25km (for satellite data) and smaller (for SAR) scales.

The most appropriate method will depend on site characteristics, particularly vegetation and climatic conditions. The most commonly used techniques, where local weather data are available from automatic weather stations, are the Bowen ratio method and the Penman-Monteith equation, although the former requires more sophisticated instrumentation, and both are likely to give good results. The Food and Agriculture Organization recommend a variant of the Penman-Monteith equation in agricultural contexts. If weather data are not available then simple lysimeters can be constructed relatively easily to directly measure evapotranspiration, with more complex versions also possible (see Gilman, 1994; Gilvear et al., 1997).

The Meteorological Office Rainfall and Evaporation calculating system (MORECS) can provide estimates of evapotranspiration averaged on a 40km x 40km grid using the Penman equation (Field, 1983). While not site specific, MORECS evapotranspiration data may be helpful in understanding patterns in other monitoring data, such as from dipwells, determining periods of water deficit and surplus and estimation of hydrologically effective rainfall.

#### 4.4.7. Geochemical methods

While water quality in peatlands is of importance for the ecology, and is discussed in this context in Section 4.4, it can also provide information on the hydrology. Water chemistry can reveal the sources of water and the temporal and spatial variability of water chemistry can reveal how these sources change over space and time. Natural levels of pH, electrical conductivity, calcium, choride, stable oxygen and hydrogen isotope ratios ( $^{18}\text{O}/^{16}\text{O}$  and  $^2\text{H}/^1\text{H}$ ), phosphorous and nitrate are typically used for this purpose. Tracers can also be added to the water to create a clearer signal in the data from different sources. These can be used to determine mean travel times for water between two points, flow pathways (e.g. Holden 2004), and water sources. The most commonly used tracers are potassium bromide (KBr), potassium iodide (KI), sodium chloride (NaCl) and isotopes of iodine, bromine, chromium, cobalt and technetium (Ronkanen and Kløve 2007; Moser and Rauert 2005).

Depending on the type of tracer or naturally occurring water quality variable used, the data collection involves either field measurement (typically for salts and dyes) or collecting samples for later laboratory analysis (e.g. for isotopes, potassium bromide and potassium iodide).

#### 4.4.8. Conclusions

Given the role of hydrology in determining the functioning of peatland ecosystems, monitoring hydrological parameters is likely to be important to gauge the effectiveness of restoration techniques where they significantly affect hydrological processes, either directly or indirectly. Monitoring water levels using dipwells is a straightforward way of establishing how the overall water budget of a site is changing over time and determining the net effect of changes to hydrology. They can be implemented with varying degrees of technological sophistication and at their simplest can be installed very cheaply. Monitoring other components of the hydrology of a site can be more complex and costly but, without monitoring a range of processes to identify causal links between changes in hydrological parameters, it may not be possible to fully assess the effectiveness of restoration techniques. For example, increases in water levels may be due to gully blocking or increased rainfall, or a combination; reduced water levels may be due to increased evapotranspiration as a result of changes to vegetation cover.

## 4.5. Biogeochemistry

### 4.5.1. Peat and water chemistry

#### 4.5.1.1. Introduction

Measuring peat and water chemistry is important for peatland restoration for a number of related reasons that are described in Anderson et al. (2006). The establishment of vegetation, associated input of OM and elevation of the water table will modify the conditions in peat and water that will impact on the nutrient balance, the carbon transformations (Francez et al., 2000), the physicochemical properties of the peat (De Mars & Wessin, 1999; Laiho et al., 2004) as well as on the size of the microbial community and its activity. Thus an understanding of changes in peat and water chemistry can aid our assessment of peatland restoration especially when assessed in conjunction with other biogeochemical parameters. Physicochemical parameters can give an indication of habitat suitability for species and can indicate breaches in environmental legislation or licenses such as through pollution. However, estimating the limits of acceptable change for physicochemical variables is complex and sometimes impossible. The tolerances of individual species to changes in nutrients, pH and even water levels are only well recorded for some species.

There are two key components to physicochemistry in peatlands: peat and water as substrates. Upland blanket bogs and lowland raised bogs are generally ombrotrophic and therefore receive water via precipitation, whilst lowland fens can be minerotrophic by receiving water via groundwater, surfacewater and precipitation. However, with low nutrient contents, such as in poor fens, they are termed oligotrophic. This is important when considering the physicochemical monitoring techniques in different peatland types. Important peat and water chemistry parameters are given in Table 18.

**Table 18** Important peat and water chemistry parameters

Group	Indicators	Techniques
Nutrients	$\text{NO}_3^-$ , $\text{NH}_4^+$ , $\text{PO}_4^{3-}$	Ion chromatography, atomic absorption
Climate	Temperature	Probe/meter
Acidity	pH	Probe/meter
Redox potential	Anaerobic status	Redox probe with platinum electrodes

As mentioned in section 4.2, Anderson et al. (2006) measured a variety of physicochemical parameters as well as microbial parameters to evaluate the success of restoration of a *Sphagnum* peatland. High N:P (>20) and N:K (>15) ratios indicated possible K and P deficiencies in restored and cutover sites, which was mainly associated with intense leaching and a high degree of decomposition of peat in these sites. Concentrations of  $\text{NH}_4$ , P and K in the top layer of the restored site were closer to those of the natural site, which indicated a possible effect of restoration on the physicochemistry of the restored site. However, microbial biomass, N:P, N:K and C:P and  $\text{NH}_4$ :biomass ratios of the restored peat showed a tendency to evolve towards values closer to those of the reference site as well as to those found in the literature for natural mires. They could be potentially interesting indicators to monitor during the years following restoration to detect nutrient deficiencies in a restored site, and to compare it to reference or cutover sites.



The potential advantages and disadvantages of physicochemical monitoring techniques compared with flora and fauna monitoring are shown in Table 19 (from Bardsley et al. 2001).

**Table 19** Advantages and disadvantages of physicochemical monitoring

Advantages	Disadvantages
Methods often precise and repeatable	May require expensive equipment, difficult to analyse and interpret
Can provide precise information and may be necessary to identify the cause of changes in communities	Long-term monitoring requires mechanisation which is expensive
May also give an indication of when things are going to change prior to that change happening which will allow remedial action to be taken	May require specialist knowledge

Bardsley et al. (2001) suggested that the efficacy of a physicochemical monitoring strategy will be dependent upon careful design and consideration of the following points:

- where to sample – for streams target run-off points to assess the maximum concentration of pollutants, or analysis of peat extracts/*Sphagnum* tissues for assessment of nutrient enrichment/deposition;
- to sample both upstream/gradient and downstream/gradient of the potential threat. This may allow the upstream data to act as a control;
- to assess whether existing monitoring can be used to provide some or all of your data needs;
- to use standard, repeatable techniques;
- to seek advice on interpretation of data and sampling strategies prior to beginning the sampling programme.

#### 4.5.1.2. pH

Quinty and Rochefort (2003) suggest that pH should be measured as it is an important factor for plants, and especially for *Sphagnum* species that are very sensitive to the level of acidity. Although pH may be measured in the planning phase of restoration, it is helpful to make additional measurements in permanent plots because restoration procedures, such as surface preparation, may cause some change. Also, pH data can contribute to the interpretation of vegetation data.

There are a wide variety of pH meters that can be used in the field or lab. pH is generally measured electrometrically. The electrometric pH reading is a product of complex interactions between the electrode and the soil suspension; differences in the soil or peat: water extraction ratio, the electrolyte concentration of the suspension, and the spatial placement of the electrode can all effect measured pH.

Water pH can be measured directly in the field using a portable meter by dipping the electrode directly in the water. Peat pH can be determined by mixing one part peat by volume with two parts

distilled water (pH 7), waiting for about 10 minutes, and taking a reading. Stoneman & Brooks (1997) report the pH readings from intact cores may be 0.5-1 pH units lower than those in peat/water slurries due to dilution effects.

#### 4.5.1.3. Redox potential

A key factor in determining chemical transformations in peatlands is the degree of aeration. In saturated peat, the pore spaces are filled with water and oxygen can diffuse only slowly through the peat. Conditions are therefore anaerobic and any oxygen present is rapidly consumed. The redox or oxidation-reduction potential is a measure of how readily a medium will donate electrons to (reduce) or accept electrons from (oxidise) any reducible or oxidisable substance. Solutions with high redox potentials are highly oxidising. With increasingly anaerobic conditions the redox potential decreases and a series of chemical transformations can take place as a result of bacterial activity (Fig. 13). This is important in waterlogged peat and soil because at low redox potential, nitrate is reduced to nitrogen, and sulphates are reduced to toxic H<sub>2</sub>S (Reddy & D'Angelo, 1994; Mitsch & Gosselink, 2000; Charman, 2002).

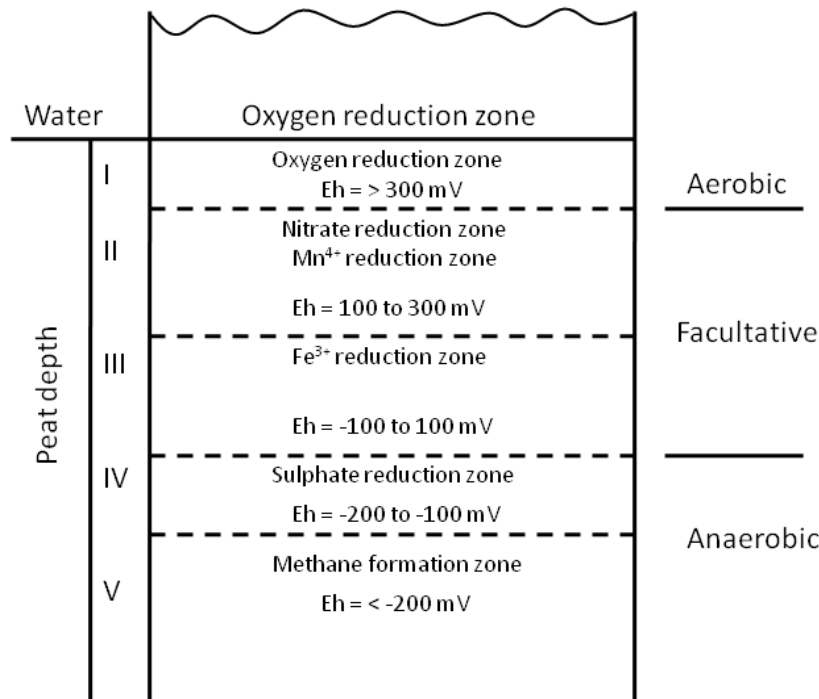

**Figure 13** Sequence in depth of chemical transformations with increasingly reduced conditions or increasing depth in peat (Reddy & D'Angelo, 1994).

Evidence in the literature indicates that restoration of peat-based wetlands by reflooding can induce the redox-mediated release of soil nutrients, thereby increasing the risk of diffuse water pollution (Niedermeier & Robinson, 2007). For the sake of improving management decisions, there is a need for more detailed studies of the underlying relationship between the hydrological and redox dynamics that explain this risk. This is particularly the case in agricultural peatlands that are commonly targeted for the creation of lowland wet grassland. Niedermeier & Robinson (2007) conducted a 12-month field study to evaluate the relationship between hydrological fluctuations and

soil redox potential (Eh) in a nutrient-rich peat field that had been restored as lowland wet grassland from intensive arable production. They found that during the summer, alternating periods of aerobism (Eh > 330 mV) in the surface layer of peat coincided with intense precipitation events. Redox potential throughout the 30–100 cm profile also fluctuated seasonally; indeed, at all depths Eh displayed a strong, negative relationship ( $P < 0.001$ ) with water table height over the 12-month study period. However, Eh throughout the 30–100 cm profile remained relatively low (< 230 mV), indicating permanently reduced conditions that are associated with denitrification and reductive dissolution of Fe-bound P. Thus redox can serve as an important indicator of microbiological processes in peat as well as variation in the hydrological regime.

To measure the redox potential, a platinum electrode is connected to an mV meter. Many pH meters also have an mV scale. It is most convenient to use a combined platinum KCl electrode. Tables are available to relate the oxidation-reduction potential  $E_h$  to the ion forms of interest, but redox alone is a useful index of the extent of oxidation or reduction in the system (Jones & Reynolds, 1996; Mitsch & Gosselink, 2000). Redox potential may give a first indication of the likelihood of CH<sub>4</sub> emissions example, but may not be significantly accurate or precise enough to be used as a proxy for budgeting CH<sub>4</sub> emissions.

#### 4.5.1.4. Exchangeable ions

The immobilisation and transformation of nutrients and pollutants are common aims of peatland restoration (Trepel et al. 2000). To evaluate success of the restoration in this respect, mass balances have to be calculated (see Davidsson et al., 2000). This may be achieved by determining the difference in concentration and volume of water in and out of the peatland.

The determination of exchangeable ions in soil or peat requires that ions on soil exchange sites be forced into a solution in which they can be effectively measured. Generally this involves flooding the exchange sites on clay and organic surfaces of soil or peat with ions from an extractant, usually a strong salt solution. The extractant, now containing exchangeable ions in addition to ions from the added salt, is separated from the soil or peat by filtering or centrifugation and is then analysed for the ions of interest such as by ion chromatography or atomic absorption (Robertson et al. 1998b).

Choice of the salt for the extractant solution will depend on the target ions (Table 20). Extractant ions must effectively displace ions from exchange sites and must not interfere with subsequent chemical analysis of the extracted solutions.

**Table 20** Types of extractants to use for specific target ions and issues (Robertson et al. 1998b).

Extractant	Target	Issues
KCl	Inorganic N (e.g. NO <sub>3</sub> <sup>-</sup> )	K <sup>+</sup> cannot be a target
NH <sub>4</sub> OAc	Total cations	Does not cover anions
BaCl <sub>2</sub>	K <sup>+</sup> and NH <sub>4</sub> <sup>+</sup>	Expensive

#### 4.5.1.5. Conclusions

Peat and water chemistry measurements are straight forward and relatively cheap for the amount of information that they provide. Nutrient concentrations, pH and redox potential should be included on every monitoring protocol and monitored at least seasonally every year at different peat depths to provide important information that relates to both plant and microbial functional development on the site. Advantages of these methods are that they are precise and repeatable, provide information necessary to identifying cause of community changes, and give an indication of when things are going to change prior to the change happening permitting remedial action. Disadvantages are that the techniques can be expensive, difficult to analyse and interpret, long-term monitoring requires expensive equipment and specialist knowledge may be required. Subsequent analysis of nutrient ratios may be used as important indicators of nutrient deficiencies that may aid adaptive management decisions.

## 4.5.2. Carbon budget

### 4.5.2.1. Introduction

Determining the carbon budget of peatland ecosystems (Worrall & Evans, 2009) is now an important aspect of management and restoration projects due to the impact of carbon dioxide and methane sources and sinks on the climate. At the Sixth Conference of Parties to the United Nations Framework Convention on Climate Change (UNFCCC) it was agreed that countries could use carbon sequestration resulting from human induced activities since 1990 on grazing land, by crop land revegetation, or by forest management (UNFCCC, 2001) to help meet reduction targets. In the UK, peatlands are the most significant wetland environment and the largest terrestrial carbon pool in the country (Cannell et al., 1993; Milne and Brown, 1997). In the UK, the majority of upland peat are grazed and as such come under the land that could be used to meet reduction targets (Worrall et al. 2003). Sinks of CO<sub>2</sub> may help to ameliorate potential global warming whilst sources of CO<sub>2</sub> and CH<sub>4</sub> may result in positive feedback to global warming. The northern peatland carbon store is estimated to be approximately 4.5 Gt C and over the Holocene northern peatlands have accumulated carbon at an average rate of 0.96 Mt C/yr (Worrall et al. 2009). An early comparison of raised mires showed that most sites in Europe have peat accumulation rates around 0.1 – 1 mm y<sup>-1</sup> (Aaby & Tauber, 1975), oceanic raised mires in Britain have accumulation rates of approximately 1 mm y<sup>-1</sup> (Barber et al., 1994), and blanket mire accumulation rates in the British Isles are more variable, with estimates of 0.1 – 1.2 mm y<sup>-1</sup> (Charman, 2002). Though they form a significant reserve, studies have suggested that at the present day they can be both sinks and sources of carbon (Shurpali et al., 1993; Whiting, 1994; Neumann et al., 1994; Waddington and Roulet, 1996). Clearly, these issues are of great importance to political as well as environmental motivations. Charman (2002) gives a good discussion of peat accumulation.

The total carbon budget or storage of carbon in an ecosystem is the net sum of a variety of biological, physical and chemical processes that are also of inherent individual importance (Fig. 14). For example, the flux of CO<sub>2</sub> and CH<sub>4</sub> are critical to determining the carbon budget, the carbon storage capacity as well as the global warming potential of a specific site. Because of the importance of these fluxes, the techniques to measure them are included separately in section 4.5.3. The soil organic matter (SOM) or soil organic carbon (SOC) (approximately 48-52 % of SOM) stock represents the net accumulation of peat from primary production and decomposition. However, the fluvial flux of C is also of importance as dissolved organic carbon (DOC), particulate organic carbon (POC), and dissolved CO<sub>2</sub> in pore and surface water that is above equilibrium with the atmosphere can be important to accurate estimates of the carbon budget of a peatland (Worrall et al. 2003). The amount of carbon stored as peat will depend on the photosynthetic fixation of carbon as net primary production, the annual accumulation of plant litter on the peat surface and the decomposition of fresh litter to CO<sub>2</sub>, CH<sub>4</sub> or fluvial components. Thus the degree of complexity required to accurately determine the carbon budget of a peatland may be beyond the monitoring capacity of most restoration projects. For this reason we have split greenhouse gas fluxes into a separate section.

Worrall et al. (2003) summarise the carbon budget of upland peat as:

Inputs:

- $\text{CO}_2$  sequestration from the atmosphere by primary production;
- Input of DOC and inorganic carbon as part of rainwater; and
- Input of inorganic carbon from weathering of underlying strata

Outputs:

- $\text{CO}_2$  and  $\text{CH}_4$  to the atmosphere as part of plant soil organism decomposition; and
- Fluvial outputs – DOC, POC, DIC and dissolved gas.

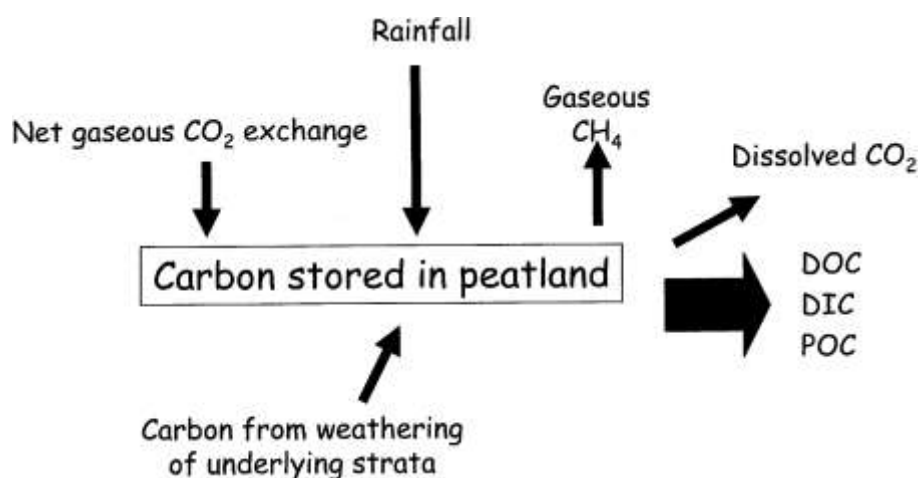

**Figure 14** Carbon uptake and release pathways for upland peat (Worrall et al. 2003).

Carbon budgets of peatlands have in general been estimated by two types of method: dating of peat accumulation, and measuring carbon fluxes between the ecosystem and the atmosphere (Worrall et al. 2009). Dating methods have typically used radiocarbon dating of peat profiles to give a rate of carbon accumulation (RCA). There are recognised problems with this technique including: long-term anoxic decay in the catotelm (Clymo et al., 1998); reservoir effects (Kilian et al., 1995, 2000); poor estimates of peat bulk density; and short term changes in carbon accumulation will not be well represented (Hilbert et al., 2000). In order to resolve some of these issues the short-lived radioisotope  $^{210}\text{Pb}$  has been used (e.g. Turetsky et al., 2004). However, such techniques are only capable of measuring the accumulation of peat and typically can only be used to estimate the average rate of accumulation above a specific horizon (Worrall et al 2009). Also, these methods only reflect peat accumulation under past conditions, and may not reflect the true state of ongoing accumulation.

Carbon budgets are critically influenced by fluctuations in water table and temperature and storm flow events. Therefore fluxes vary throughout the year, and measurements need to be taken at either regular intervals or ideally during different weather conditions, e.g. within or directly after a storm flow event. The most important fluxes of carbon are the gaseous fluxes (section 4.5.3.) particularly  $\text{CO}_2$ , as well as the organic fluvial fluxes of DOC and POC (Table 21). Since the accuracy of

carbon budgets required for restoration and management projects is probably not as demanding as peer-reviewed publications, we have only considered these fluxes and referenced the remaining minor fluxes.

**Table 21** Groups of variables relevant to the carbon budget of a peatland.

Group	Indicators	Techniques
Carbon stock	SOM, SOC, Plant biomass (NPP)	Loss on Ignition CN analyzer Bulk density
Greenhouse gas fluxes	CO <sub>2</sub> , CH <sub>4</sub>	Gas flux chambers Eddy covariance
Fluvial carbon	DOC, POC, DIC, Dissolved gas	Stream water or dipwell samples analysed in the laboratory, run-off traps, erosion pins

#### 4.5.2.2. Net primary production

The biotic carbon stock represents the net accumulation of carbon in either pool from the inputs and outputs of carbon. Thus, if a full carbon budget is to be attempted, care must be taken not to double count carbon that may be accounted for in other measurements. However, estimates of plant biomass and plant carbon content can be used to determine the input of carbon via net primary production. Odum (1971) defined it: "net primary productivity is the rate of storage of organic matter in plant tissues in excess of the respiratory utilization by plants."

A full description of NPP has not been attempted here as its determination is complex and depends on the species, particularly between vegetation types such as woody species and mosses due to their growth strategies. A full description of all available techniques is provided by Sala et al. (2000). Vitt (2007) provides extensive information for estimating moss and lichen ground layer NPP in peatlands. Methods for measuring annual growth of different vegetation types include innate markers (leaf and stem patterns), surrogate markers, cranked wires ( ), strings/pins/Velcro, netting, plugs, and surface marks. Vitt (2007) also provides information on scaling length growth to annual NPP using shoot density, clipping, and biomass.

For *Sphagnum* species with high densities or large capitula, cranked wires implanted in early spring are recommended in which the exposed wired implanted within a dense canopy is measured for estimating the length of the annual growth of the moss shoot. Clymo (1970) provides detailed background information on *Sphagnum* NPP as well as the cranked wire method. Also see Asada et al. 2003 and Vitt, 2007 for details. Wires used a remade of 1 mm stainless steel welding rod and generally are available in 1 m lengths. A minimum of 50 wires per plot and 250 wires per site is suggested (Vitt, 2007). Sets of 50 wires per species/microhabitat nested within a site or a transect through a diversity of species/microhabitats are suitable designs. Calculation of production should be done by multiplying the annual growth (in mm) by bulk density (g cm<sup>3</sup>) of the estimated 1 to 2 year *Sphagnum* canopy after removal of the capitula.

There are a variety of other methods for determining NPP depending on the vegetation type, the accuracy required and the time/resources available such as gas flux and stable isotope analysis (see Fahey & Knapp, 2007).

#### 4.5.2.3. Organic matter

Organic matter (OM) is composed primarily of the remains of plants in various stages of decomposition and accumulates in peat due to the anaerobic conditions that inhibit aerobic microbial processes. Peat is a generic term for relatively undecomposed OM and is not usually strictly defined. Most peats contain less than 20 % unburnable inorganic matter (and therefore usually contain more than 80 % burnable OM, which is about 40 % organic C) (Mitsch & Gosselink, 2000). As the OM content of peat is the principle store of carbon it would seem reasonable that monitoring of the organic matter content would be important to restoration. For example, Ying-Bing et al. (2004) determined the change of quantity, quality and distribution, of OM in the process of wetland ecological restoration. They found that with the restoration of the wetland ecosystem, the amount of soil organic carbon increased greatly. Bellamy et al. (2005) have shown that carbon was lost from soils across England and Wales over the period 1978-2003 at a mean rate of 0.6 % year (relative to the existing soil carbon content). The relative rate of carbon loss increased with soil carbon content and was more than 2 % year in soils with carbon contents greater than 100 g kg (i.e. peats). Thus long-term changes in SOM may indicate loss or storage of carbon. However, their suggestion of a link to climate change irrespective of land use change has been questioned by Smith et al. (2007). Smith et al. (2007) presented results from modelling studies, which suggested that, at most, only about 10–20% of the soil carbon losses in England and Wales observed by Bellamy et al. (2005) could possibly be attributable to climate warming. Further, the actual losses of SOC from organic soils in England and Wales may have been lower than those reported due to a number of other explanations for the loss of carbon. Thus, OM content may only provide useful information with long-term monitoring particularly in conjunction with accurate bulk density estimates and other measurements. It may not be useful for short-term monitoring of peat restoration due to the slow turnover of OM and the number of factors that affect its composition due to the complexity of the C cycle in peatlands. Nevertheless, there are routine methods for determining OM that are relatively straight forward, and its determination is essential for accurately determining the carbon storage and budget of a peatland.

Dry combustion is the most suitable method for routine analysis of OM and total C (Sollins et al., 1998). OM is generally determined by either (1) loss on ignition (LOI), or (2) by combustion at >1000 °C on a CN analyzer which analyses the production of CO<sub>2</sub>. Measuring organic carbon content by measuring mass loss following high-temperature (500-600 °C) combustion (LOI) is easily performed. The material lost is organic matter and the material remaining is mineral ash. The organic carbon content is approximately 50 % of the organic matter content.

Modern C and N (CN) analyzers oxidise small samples at high temperatures (>1000 °C) in an O<sub>2</sub>-enriched atmosphere, then measure the resulting gases by gas chromatography (CO<sub>2</sub> and N gases) or infrared gas analysis (CO<sub>2</sub> only) (Nelson & Sommers, 1996; Robertson & Paul, 2000). Small sample size means that great care must be taken to adequately subsample and powder the sample to be analyzed. Conversion of gravimetric results to an areal extent is crucial for including OM C in total ecosystem carbon budgets and for making comparisons of SOM across sites and depths. It is thus critically important to have accurate values for both bulk density and horizon depths (Robertson & Paul, 2000). The C/N ratio obtained can also provide important information. High C/N ratios mean low humification/decomposition, so if there is an increase in the ratio then this suggests accumulation of OM which is not highly decomposed. Conversely, if the ratio declines and is low (moving towards 12), this implies strong decay and conditions not conducive to peat build-up.

The Walkley-Black technique, a wet combustion method, is no longer recommended because it can underestimate soil C by 20-30 % (Nelson & Sommers, 1982) and can give spurious results in highly



reduced soils unless precautions are taken (Snyder & Trofymow, 1984). The Walkley-Black method is also laborious and produces toxic wastes (Sollins et al., 1998).

#### 4.5.2.4. Fluvial carbon stock

##### 4.5.2.4.1. POC

Samples for POC, DOC and DIC analysis can be collected from dipwells and streams, or through water extraction of the peat in the laboratory by centrifugation. Normally samples are collected in streams as peat processes affect the solubility of POC and DOC. Stream water samples are recommended as they represent the export of POC and DOC from the peatland. The water samples collected are filtered through 2 mm mesh to remove large particles. The term POC is used for the carbon that will be retained on a 0.45  $\mu\text{m}$ -membrane filter whilst DOC is less than 0.45  $\mu\text{m}$ . The carbon concentration of the filtered water (DOC below) and the carbon concentration of the unfiltered water (TOC) may be determined rather accurately by carbon analyzers along with inorganic carbon (where  $\text{TOC} = \text{TC} - \text{IC}$  and  $\text{DOC} = \text{DC} - \text{IC}$ ). POC is then calculated as  $\text{TOC} - \text{DOC}$  (see Nollet, 2000).

##### 4.5.2.4.2. DOC

Peat is an important terrestrial carbon store. However, heightened levels of degradation in response to environmental change have resulted in an increased loss of dissolved organic carbon (DOC) and an associated rise in the level of discolouration in catchment waters. A significant threat to peatland sustainability has been the installation of artificial drainage ditches. Although recent restoration schemes have pursued drain blocking as a possible strategy for reducing degradation, fluvial carbon loss and water discolouration, little is known about the influence of drainage and drain blocking (Wallage et al. 2006). on the biological processes operating within these soils.

A recent unpublished study by Höll et al. (*in press*) demonstrates that 20 years of peatland restoration by rewetting in south-west Germany reduced DOC concentrations and increased small organic molecules in different depths due to a reduction of decomposition following water table recovery. Thus restoration of the water table by blockage of drainage ditches has a positive impact on C sequestration in peatlands and DOC may be a good indicator of that impact and the success of restoration over a sufficiently long time period.

All stated above, samples are passed through 0.45  $\mu\text{m}$  filter papers to remove POC. The water samples are analysed for total carbon (TC) and total inorganic carbon (TIC) where  $\text{DOC} = \text{TC} - \text{TIC}$ . DOC in soil water sampled from dipwells may differ from concentrations exported in stream water (findings by Evans and Worrall and their teams on Bleaklow, NE/MFF unpubl.). This is likely to be related to peat processes and it may therefore be advisable to measure stream water contents directly, if the DOC export is of concern, or when establishing a catchment C budget. A less expensive proxy for DOC concentrations employed by many water companies is water colour, measured in degrees Hazen that correlates well with DOC (see Freeman et al. 2004; Worrall et al. 2003, 2009). Also, Worrall et al. (2003) estimated DIC using the methods of Neal et al. (1998) which is based on pH and alkalinity measurements. Samples should be collected for fluvial carbon at monthly intervals to account for seasonal variation but notice should also be made of storm events that can increase levels dramatically.

#### 4.5.2.5. Conclusions

Determining parameters associated with the carbon cycle in peatlands is useful not only for understanding the C budget, but relating C to other parameters may offer deeper insight into the progress of peatland restoration success. Dating methods used for assessing the C budget of peatlands are only capable of measuring past peat accumulation and may not reflect ongoing accumulation. NPP of *Sphagnum* species can be determined accurately using the cranked wire method. Determination of SOM may be useful for long-term studies but will probably not provide useful information in the short-term. Loss on ignition is relatively straightforward and inexpensive. However, CN analysis which is more expensive and time-consuming may be more accurate as well as providing a C/N ratio. Both methods require accurate estimation of the bulk density to provide good estimates of the carbon budget. POC and DOC are major fractions of the C budget in peatlands and should be monitored at least seasonally when possible. The methods are straightforward, and inexpensive but can be time-consuming. These determinations are particularly important for catchment blanket bog with grip management. Restoration of the water table by blockage of drainage ditches has a positive impact on C sequestration in peatlands, and DOC may be a good indicator of that impact and the success of restoration over a sufficiently long time period.

### 4.5.3. Greenhouse gas fluxes

#### 4.5.3.1. Introduction

The monitoring of greenhouse gas fluxes are obviously important to current management and policy objectives, but are also a key aspect of the carbon budget of peatland ecosystems (i.e. CO<sub>2</sub> and CH<sub>4</sub>) (Worrall et al. 2003). Worrall et al. (2003) reported the gaseous flux from peatlands as  $0.59 \pm 0.06 \text{ Mt C } \gamma^{-1}$  for CO<sub>2</sub> and CH<sub>4</sub> exchange compared to the fluvial flux of  $0.27 \pm 0.02 \text{ Mt C } \gamma^{-1}$ . Best and Jacobs (1997) showed that upon restoration of the water table in a ditch-dissected peat, CO<sub>2</sub> emissions decreased from 282 to 244 g C m<sup>-2</sup> γ<sup>-1</sup> whilst CH<sub>4</sub> production rose from 0.6 to 2.1 g C m<sup>-2</sup> γ<sup>-1</sup>. Thus monitoring greenhouse gas fluxes are important parameters to measure during peatland restoration as they provide relevant information on biogeochemical processes (i.e. microbial and vegetative growth) as well as indicating the trajectory of ecosystem services (i.e. carbon sequestration). Trace gas exchange can also provide an important pathway for ecosystem inputs and losses of nitrogen (i.e. N<sub>2</sub>O, N<sub>2</sub>) (Holland et al. 1998). However, microbial processes responsible for N gas fluxes such as denitrification are generally low in upland blanket bogs due to nitrate limitations but maybe of importance in lowland riparian peat systems where nitrate concentrations are higher. Models that do not incorporate gaseous loss pathways can substantially overestimate net primary production and long-term storage of both carbon and nitrogen (Schimel et al. 1997). Despite the importance of greenhouse gas exchange at the NE workshop meeting only two sites monitored greenhouse gas exchange and only methane was measured.

Whilst the focus may be on the emission of greenhouse gases from a peatland, gases such as CO<sub>2</sub> and CH<sub>4</sub> are actually exchanged between the peat, vegetation and atmosphere. Plants fix CO<sub>2</sub> by photosynthesis whilst peat and vegetation emit CO<sub>2</sub> via respiration. The difference between these fluxes is called the net exchange:

$$\text{Net exchange of CO}_2 = \text{Gross photosynthesis} - \text{ecosystem respiration} \quad \text{Eq.1}$$

The exchange of CH<sub>4</sub> is determined by the production of CH<sub>4</sub> in waterlogged anaerobic zones of the peat by methanogenic microorganisms, transfer of CH<sub>4</sub> up the peat profile, and oxidation of the CH<sub>4</sub> by methanotrophic organisms in the upper aerobic layer. However, due to the anaerobic conditions in peat, methanogenic respiration usually dominates resulting in the emission of CH<sub>4</sub>. Certain plants can also serve as conduits for CH<sub>4</sub> such *Juncus* with tissue called aerenchyma. For a detailed description of the processes involved see Mitsch & Gosselink (2000) and Maltby & Barker (2009).

Anderson et al. (2006) measured CO<sub>2</sub> respiration in a natural, restored and cutover *Sphagnum* peatland. The natural peatland site had significantly ( $P < 0.05$ ) greater cumulative C–CO<sub>2</sub> production (surface aerobic: 4.5–8.7 mg C–CO<sub>2</sub> g<sup>-1</sup> h<sup>-1</sup>). The poor organic matter quality was the main explanation for the low respiration rates of the surface layer in the restored and the cutover site. Methane production was detected at low but measurable rates in the natural and the restored samples, but not in the cutover peat. Methane production, as expected, seems to be closely associated with hydrological properties, and therefore hydrological monitoring would complement monitoring of methane. Nonetheless, more experiments on microbial community composition are still needed to enhance our understanding of colonization processes occurring in restored and cutover sites.

GHG fluxes are dependent on a wide spectrum of site parameters that vary strongly over the year, including water level, temperature, vegetation growth and actual land use. Assessing annual GHG balances therefore requires highly frequent and prolonged observations to catch daily and seasonal variability. A sufficiently dense net of observations is necessary for the chamber method to cover the often fine-scale spatial patterns that are so typical for natural and degraded peatlands. To assess the

effects of the restoration measures in terms of average annual GHG fluxes, the observations have to cover several complete years to reduce the effect of inter-annual differences in weather (Joosten & Couwenberg, 2009).

The details provided in this section are referenced to Holland et al. (1998) and Matson & Goldstein (2000). There are a wide variety of techniques available for the measurement of gaseous fluxes that range from single point to measurements that can be integrated over kilometers. Each technique has its own advantages and limitations, each with a set of conditions or range of questions for which it is most appropriate. Choice of the approach or combination of approaches depends on the scientific question being addressed, the biophysical characteristics of the study site, the analytical capabilities for the gases of interest, and the facilities and funding available. A more detailed review of the methods can be found in Lapitan et al. (1999).

#### *4.5.3.1.1. Comparison of techniques*

At the finest scale, soil atmospheres can be determined using stainless steel or Teflon probes placed at various depths in peat. For flux measurements at spatial scales ranging from 0.1 to 1 m<sup>2</sup>, enclosures (chambers) are placed on the surface of the peat, allowing gas to accumulate over time and enabling the calculation of accumulation. Ten m<sup>2</sup> enclosures called cloches with laser detectors have also been used at a variety of sites (i.e. Lake Vyrnwy, UK Popnet). Because of the enclosure and limited spatial resolution of the closed-chamber method it was found suitable for detecting small fluxes of trace gases (e.g. N<sub>2</sub>O), studying processes, and identifying sources of spatial variations controlling gas fluxes (Livingston and Hutchinson, 1995). Chamber techniques measure the entire CO<sub>2</sub> efflux, but it is impacted by chamber effects: crypto-climate and changing CO<sub>2</sub> concentration. Chamber techniques allow measurement of individual ecosystem components of CO<sub>2</sub> fluxes but a very high number of measured points are needed to sufficiently describe an ecosystem level. For flux measurements at larger spatial scales, fluxes can be estimated using micrometeorological measurements on towers. Micrometeorological methods provide nondestructive, integrated measurements of gas fluxes over large areas, but generally require large, uniform fetch. Tower-based and airborne eddy flux correlation methods require expensive fast-response sensors and logistical support. Such measurements characterise the vertical gradient and flux of a gas integrated over areas ranging from 0.5 to 100 ha. Fourier transform infrared (FTIR) spectrometer and differential absorption (LIDAR) measure gas concentrations (although not flux measurements) and integrate over distances as long as several kilometers.

When compared, different methods provide similar estimates of fluxes despite differences in pros and cons of each technique (Table 22). Aircraft and tower flux measurements of carbon dioxide fluxes over the Konza tallgrass prairie were highly correlated (Desjardins et al. 1993). Comparison of N<sub>2</sub>O fluxes using different chamber techniques (closed versus open and chambers of different volumes), different micrometeorological techniques (eddy covariance, flux gradient and conditional sampling using two tunable diode lasers, an FTIR and a gas chromatograph), and chamber versus micrometeorological techniques show a reasonable agreement provided the patchiness of the landscape is taken into account when examining micrometeorological measurements from different wind directions (Christensen et al. 1996). The two most frequently used techniques for measuring surface-atmosphere gas exchange are micrometeorological and enclosure techniques. The choice of technique will depend on a number of factors such as the size of the projects budget, the objective of restoration, the type of restoration, the level of scientific robustness required and the design of the monitoring protocol.

**Table 22** Enclosure techniques versus micrometeorological techniques for measuring greenhouse gas fluxes

Enclosure techniques	Micrometeorological techniques
Inexpensive	Expensive
Disturbs peat	Does not disturb peat
Short time scales	Long time scales
Small datasets	Large datasets

#### 4.5.3.2. Enclosure techniques

Enclosures cover the surface of soil, sediment or peat in order to restrict the volume of air available for exchange, so that any net flux between the enclosed air and peat can be measured as a change in headspace gas concentration. Enclosure techniques are relatively inexpensive, simple to operate, require less data analysis and manipulation than micrometeorological methods, and use equipment that can be easily be moved from one location to another, thus allowing sampling of many locations within a landscape. There are two basic types: *static* and *flow-through*. Static designs contain a small port to permit sampling and a small vent to permit equilibration of internal and external atmospheric pressures (Fig. 15). Flow-through designs may be steady-state (in which the enclosure is swept with air draw from a source of known concentration resulting in a “steady” concentration gradient across the air-peat interface within the enclosure) or non-steady state (in which the trace gas concentration gradient diminishes in response to continual concentration changes within the enclosure) (Fig. 16). Static chambers may be most suitable for peatlands as they are relatively inexpensive, require short incubation periods, and the low flux rates with the exception of CH<sub>4</sub> hotspots will not significantly affect the concentration gradient. A review of the possibilities and the considerations needed for each type of enclosure is provided in Denmead (1979), Kanemasu et al. (1974), Jury et al. (1982), Hutchinson and Livingston (1993), Livingston and Hutchinson (1995), Welles et al. (2001) and Reichman & Rolston (2002). A method and procedure for gas sampling with collars is provided in Appendix 4.1. The calculations required to determine the flux rate are provided in Appendix 4.2

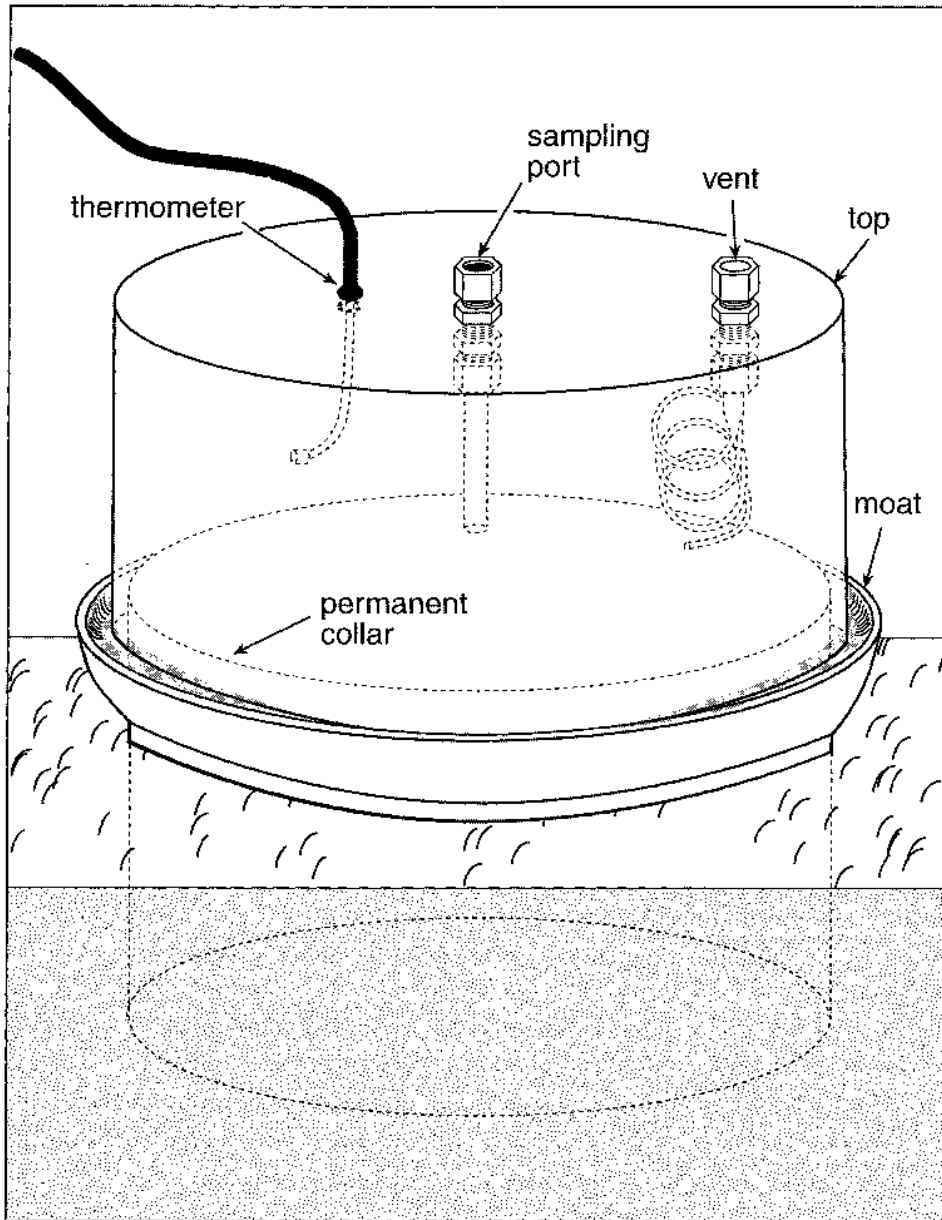
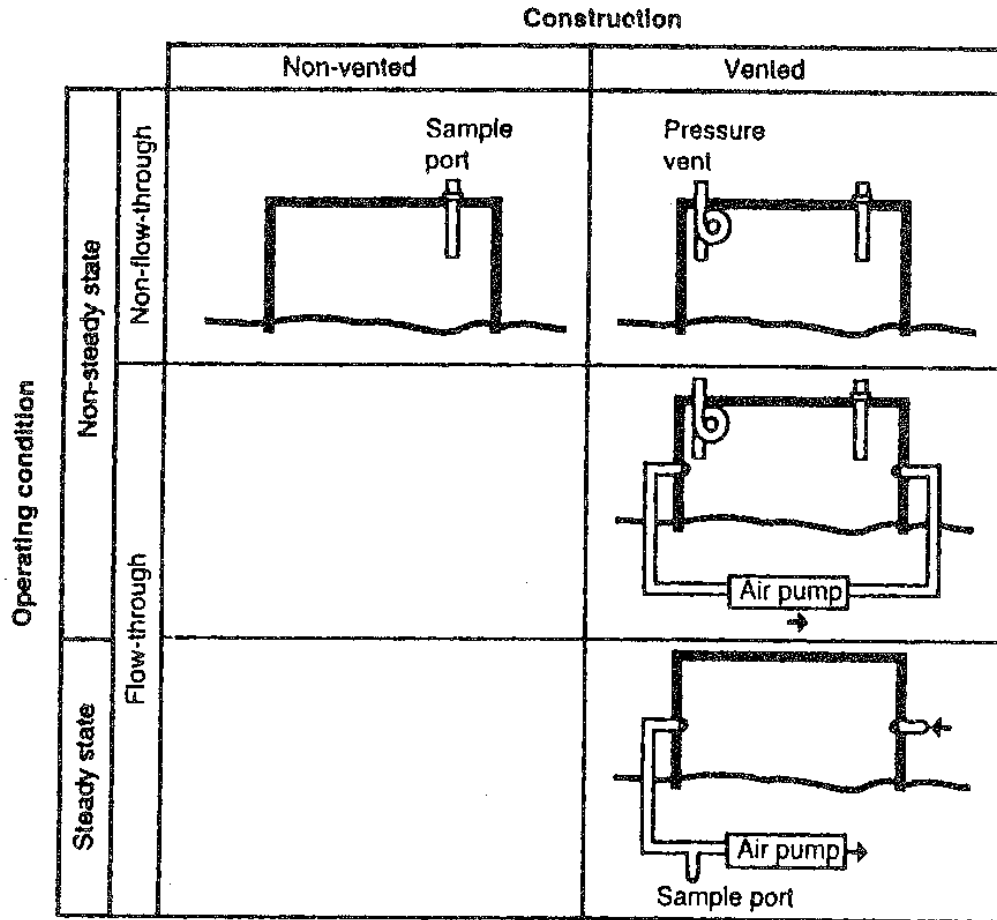

Figure 15 Recommended static enclosure design by Holland et al. (1998).



**Figure 16** Classification system for enclosures (from Livingston & Hutchinson, 1995 in Matson & Goldstein, 2000)

#### 4.5.3.2.1. Enclosure construction and design

The objectives of enclosure design are to be as non-invasive as possible, and to avoid pressure or temperature changes and excessive trace gas concentration increases. Enclosures are constructed in two parts: (1) a permanent collar, which is put in place prior to sampling and left in place for the duration of the sampling period, and (2) the enclosure itself, which is placed on the collar for the short period over which gas samples are collected (Holland et al. 1998).

Matthias et al (1978) provide a complete discussion of enclosure geometry. The enclosure's surface area to volume ratio determines sensitivity. A cylindrical rigid enclosure (usually 500-900 cm<sup>2</sup>) is typical. Larger surface areas have the advantage of capturing more of the local peat heterogeneity. The ratio of chamber volume to surface area covered is one of the most critical issues of chamber design (Matson & Goldstein, 2000). Volume-to-area ratios of field chambers are typically 15 or greater. All construction materials (including sealants) must be made of inert materials that do not react or "bleed" with the gases to be measured such as silicon sealants. Stainless steel and PVC (opaque to prevent light penetration and associated temperature changes) have been used successfully for greenhouse gases.

The preferred design of an enclosure includes a sample port, a properly sized vent, a permanent collar, and a moat to provide a gastight seal between the permanent collar and enclosure. If the goal of monitoring is short-term measurement of fluxes, it may be desirable to use portable enclosures that have a skirt secured by an inner tube filled with sand. Static chambers for gas collection are inexpensive and do not require electricity or security and are therefore suitable for remote locations. Flow-through chambers with IRGAs are expensive partly for these reasons but are more accurate and precise, and will also provide substantial data with loggers at shorter hourly periods (see Savage & Davidson, 2003 for comparison of manual automated systems).

#### 4.5.3.2.2. Sampling strategy

The principle goal of monitoring greenhouse gas fluxes could be to determine the net exchange of gases between the ecosystem (peat and vegetation) and the atmosphere. However, the plant and microbial processes responsible for the overall net fluxes can be determined if required. For example, ecosystem respiration (the sum of plant and peat respiration) can be estimated by measuring the net exchange of CO<sub>2</sub> under dark conditions (i.e. photosynthesis is temporarily inhibited). Removable black-out covers can be purchased commercially. Gross photosynthetic activity (which relates to net primary production) can then be determined by rearranging equation 1.

Successful enclosure sampling requires consideration of several temporal scales for non-flowthrough designs. Holland et al. (1998) recommend a deployment time of no shorter than 5 minutes and no longer than 1 hour. Continuous sampling (e.g. CO<sub>2</sub> using a flow-through IRGA system connected to a data logger) have shown that fluxes are usually perturbed for the first minute following the placement of the enclosure. The potential influence of deployment time on the calculated flux (the linear increase in gas concentration over time) has been evaluated by Healy et al. (1996), who have shown that long deployment times lead to significant underestimates of the flux.

The overall sampling strategy should build on the peat information available at a given site and be sufficiently specific to address the objectives of the monitoring programme. Trace gas fluxes typically have high spatial and temporal variability; indeed, this variability is one of the reasons that micrometeorological techniques, which integrate over whole ecosystems and allow for long-term continuous sampling, are the preferred approach in some situations (see section below). Focusing of sampling in areas assumed a priori to be “representative” or “typical” can lead to biased extrapolation estimates and erroneous conclusions (Matson & Goldstein, 2000). Enclosure-to-enclosure variation in fluxes is considerable, and the resulting measurements are usually not normally distributed. Estimates of the number of enclosures required to characterise the flux of a gas from a given area range between 50 and 100: the larger the flux the greater the variance (Holland et al. 1998). However, because of labour and time constraints, only rarely are a sufficient number of enclosures deployed for confident characterization of a site. As a result, the measurements could be analysed with the appropriate statistical techniques that accommodate non-normally distributed data or log transformed prior to analysis.

Fluxes of greenhouse gases can vary diurnally, seasonally, and inter-annually depending on climate, substrate availability and other factors. The variations must clearly be taken into account when monitoring greenhouse gas fluxes following restoration of a peatland site. In many cases, gas fluxes peak during seasonal transitions or immediately following precipitation or fertilization. If the goal of the monitoring is to develop an annual estimate of flux, the *minimum* sampling requirement is once per month with more frequent sampling during the time of peak flux. For sites where the peak flux is in the spring, this requires increasing the sampling frequency to weekly or biweekly. For sites where



peak fluxes follow precipitation or fertilization, hourly sampling may be required to fully characterise the response. In all cases, decisions about sampling frequency should be based on the objectives of the restoration. Light conditions (photosynthetic photon flux density = PPFD) also have a dramatic impact on fluxes due to the instantaneous effect on photosynthesis. Care must also be taken that exposure to high PPFDs does not increase gas chamber temperatures by using short incubation periods. As mentioned earlier temporal variation in gaseous fluxes is considerable due to the impact of light conditions, temperature and moisture and therefore the time of the day to repeatedly sample must be considered carefully prior to starting a monitoring programme - for example, midday is usually chosen as light conditions are highest. Obviously this is only an issue for manual monitoring approaches as automatic methods can take repeated measurements throughout a 24 hour period. Consideration of measurements at night time is suggested, particularly in summer when photosynthesis and respiration are highest, in order to obtain a better estimate of net exchange over a long time period.

Disturbance of peat associated with collar placement or sampling activities should be minimised; frequent sampling may require a semi-permanent boardwalk as heavy footsteps can force release of gases such as CH<sub>4</sub> in peat and organic soils. Polypropylene syringes (available from medical supplies) are inexpensive and have minimal contamination problems. However, sample storage in syringes with three way valves should be limited (no more than 24 hours) because gases diffuse through the walls of polypropylene syringes (Holland et al. 1998). Glass gas vials can be used for longer periods. Pressure differentials during transport can cause leakage where field temperatures are different from laboratory temperatures. To protect against this, the syringe can be slightly pressurised with a rubber band over the syringe and plunger. Alternatively, gases can be injected into pre-evacuated glass vials with septa and maintained at a positive pressure. This is more expensive but may also be required for some GCs with autosamplers. Samples should be stored along with gas standards ideally in glass vials. All septa and glass vials should be tested under pressure prior to actual sample collection.

It is suggested that 6 or more replicate gas samples are collected over an incubation period within a pilot gas sampling study to determine the optimal incubation period for gas sampling. This data is plotted to determine the period of time over which the flux is linear as the rate of flux should be linear for the whole incubation period. Following this pilot study, the number of replicates collected can then be reduced to 2 or 3 samples and the assumption of linearity can be tested again when seasons change. The time taken to collect the initial (background) gas sample from all enclosures to the final second or third sample, must also be taken into account when deciding the incubation length. However, non-linear regression analysis can be used as Nakano (2004) found that linear regression was not a good model of the change in headspace concentration with time. They provide a good review of the issues surrounding diffusion gas fluxes in closed chambers. If 50 or more gas enclosures are being sampled over a wide area, the cost of analysing the samples by gas chromatography may approach or exceed the cost of eddy covariance techniques. Alternatively, *in situ* analysis using IRGA may be less expensive for large areas or a large number of enclosures. The choice will depend on the number of enclosures, the number of samples for estimating flux (dependent on precision required), time available and cost of analysis.

#### 4.5.3.2.3. Gas analysis

Gas chromatography is ideal for measuring greenhouse gases as they can be injected simultaneously. For measurement of CO<sub>2</sub> a methanizer is required to convert each CO<sub>2</sub> molecule to a molecule of CH<sub>4</sub> which can then be determined with a flame ionisation detector (FID). Both CH<sub>4</sub> and CO<sub>2</sub> are

determined on the same detector at different times due to the separation of CO<sub>2</sub> and CH<sub>4</sub> due to the stationary phase of the GC column. The carrier gas is usually N<sub>2</sub> or He. For more information see Holland et al. (1998). Measurement of N<sub>2</sub>O requires a GC equipped with an electron capture detector (ECD) which can be in parallel with an FID on a separate column to permit simultaneous measurement of CO<sub>2</sub>, CH<sub>4</sub> and N<sub>2</sub>O. An oxygen/water trap should be placed in the carrier gas line upstream of the GC to prevent damage to the ECD. If the ECD is used in conjunction with an FID, then N<sub>2</sub> is generally used as the carrier gas.

CO<sub>2</sub> fluxes can also be measured by a number of other methods such as IRGA or soda lime absorption. Both soda lime and base trap (NaOH and KOH) absorption tend to underestimate high CO<sub>2</sub> fluxes and overestimate low CO<sub>2</sub> fluxes as a result of varying absorption efficiencies (Nay et al. 1994). Holland et al. (1998) therefore do not recommend using base traps for routine flux measurements. For enclosure measurements, IRGA analysis is cheaper and faster than GC analysis, and direct if attached at the end of a flow-through design. PP Systems <http://www.ppsystems.com/> and Licor Inc. <http://www.licor.com/env/> provide soil chambers and leaf cuvettes linked to a portable IRGA system for rapid determination of CO<sub>2</sub> fluxes. However, users should be aware that (1) field calibration is needed to correct for temperature dependencies of the instrument, (2) the measured flux may be affected by the instrument flow rate, and (3) chamber volumes may be inappropriately small for peat vegetation. However, chambers may be purpose built and attached to an IRGA system.

#### 4.5.3.3. Micrometeorological techniques

For projects where the goal is to produce an estimate of trace gas exchange over large areas (> 10 m<sup>2</sup>), micrometeorological techniques are preferable because they incorporate much of the meter-to-meter variation (Lenschow, 1995). Multiyear deployments at the Harvard Forest have been highly successful in providing insights in regional carbon exchange and storage on both an intra-annual and an interannual basis (Goulden et al. 1996). While chambers/enclosures have advantages in that they are portable and inexpensive, micrometeorological approaches using towers or aircraft have other important advantages. Whilst they do not disturb the peat, plant or water surface, they also inherently average over a surface area that increases with height of the measurements over the surface, and so represent integrated fluxes from a larger proportion of the ecosystem rather than from small plots within it (Matson & Goldstein, 2000). They also allow the examination of fluxes over continuous time scales from minutes to years.

There are a variety of micrometeorological techniques for measuring greenhouse gas fluxes. As with the enclosure approach, no single technique is best for all gases or all situations. For a discussion of eddy correlation, eddy accumulation, gradient and difference techniques, and mass balance and Bowen ratio techniques, Matson & Goldstein recommend Lenschow (1995) and Moncrieff et al. (2000). The major disadvantage of micrometeorological techniques is that they are expensive. However, Billesbach et al. (2004) describe a portable eddy covariance system for the measurement of ecosystem–atmosphere exchange of CO<sub>2</sub>, water vapor, and energy.

The eddy-covariance technique measures the flux of a scalar (heat, mass) or momentum at a point centred on instruments placed at some height above the surface (Fig. 17). Eddy covariance measures net vertical turbulent CO<sub>2</sub> flux between the atmosphere and surface (vegetation and peat). This should represent the sum of photosynthesis and respiration in a fully adjusted boundary layer (the layer of atmosphere that is in equilibrium with mass and energy exchange with the surface) (Myklebust et al., 2008). Its main advantages are no impact on any of the studied objects and

homogenized information for predominantly the ecosystem level. Nevertheless, there is a major problem in using of measured data: difficult identification and quantification of advection occurrence. The advection can underestimate or in some cases overestimate fluxes especially at night. Using the convention that photosynthesis is negative and respiration positive, chamber-based estimates tend to be higher than eddy covariance measurements (Myklebust et al., 2008; Curtis et al., 2005; Launiainen et al., 2005; Bolstad et al., 2004; Janssens et al., 2001). The cause of this apparent bias is not understood though the general lack of energy balance closure suggests that eddy covariance may be underestimating NEE (Wilson et al., 2002). However, due to the large uncertainties in scaled-up chamber measurements, underestimation by EC is not confirmed (Myklebust et al. 2008). Myklebust et al. (2008) reviewed the uncertainties in the eddy covariance technique that vary with differences in sampling design, data treatment, data cleaning protocol, gap filling techniques, and site characteristics such as canopy heterogeneity, leaf area index, topography and patterns of advection. Many of the uncertainties can be reduced by measuring over an extensive horizontally homogenous surface on flat terrain and with a steady atmosphere (Baldocchi, 2003). Thus the technique is probably most appropriate to large expanses of blanket bog or moorland. Also, the technique may be inappropriate for small-scale sites, particularly when detailed statistical analysis of site variability over spatial and temporal dimensions are required.

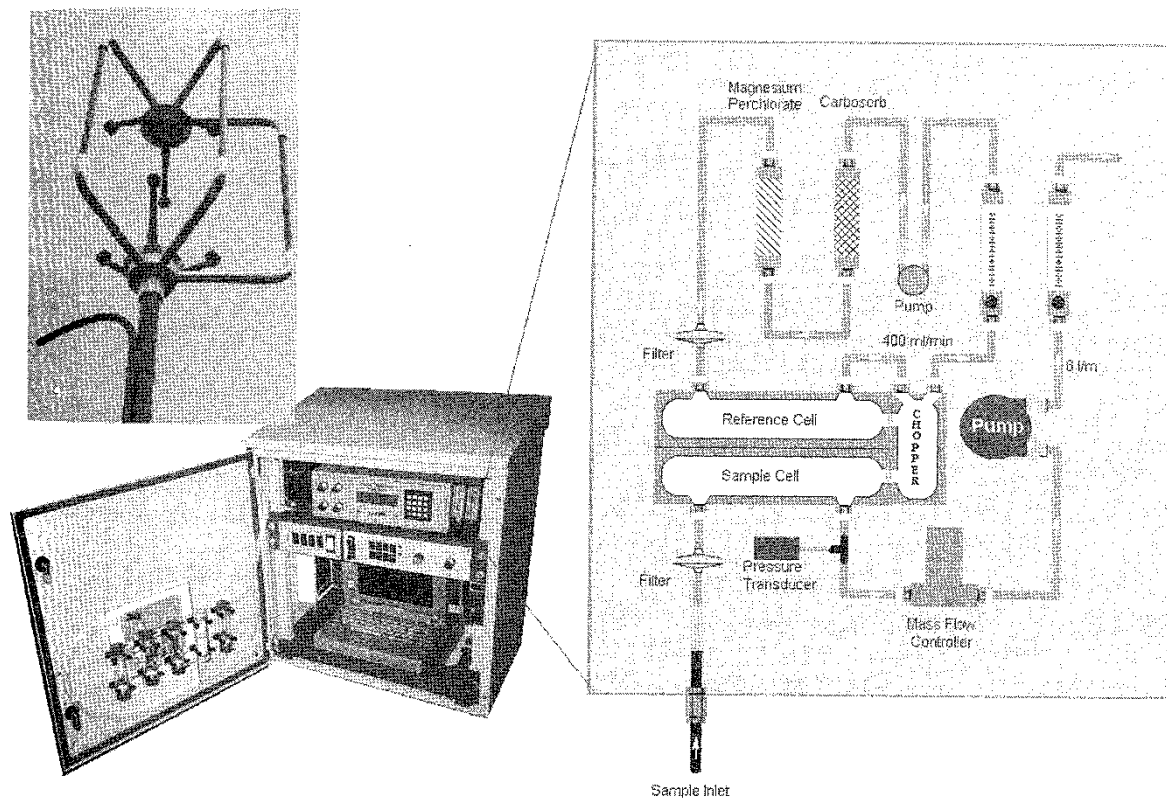

**Figure 17** A schematic of a typical eddy covariance system. A sonic anemometer (top left) above the canopy measures the turbulent fluxes of horizontal and vertical wind speeds. Air sucked down an inlet tube near the sonic head to a fast-responding infrared gas analyzer (bottom left) at the base of the tower. The expanded schematic (right) shows the gas path within the gas analyzer. A mass flow controller and pressure transducer can be used to maintain a constant rate of flow down the sample tube (and hence constant lag of gas sample between the sonic head and optical bench of the IRGA). Gas concentrations in the sample cell are measured relative to a reference cell in which air is dried and scrubbed of carbon dioxide (from Moncrieff et al., 2000).

#### 4.5.3.4. Proxies for peatland greenhouse gas fluxes

As greenhouse gas fluxes are difficult, time consuming and expensive to measure directly, indirect methods – via ‘proxies’ or proxy variable can be used for assessing fluxes (Joosten & Couwenberg, 2009; Couwenberg et al. 2008). A proxy may not be of interest in itself but the variable of interest can be deduced from it. To be reliable, the proxy variable must have a close correlation with the variable of interest.

Three parameters are currently emerging as suitable proxies for peatland greenhouse gas fluxes – water level, vegetation, and subsidence. Meta-analyses of a large amount of data from various parts of the world have revealed that mean water level is the best explanatory variable for annual GHG fluxes (Couwenberg *et al.* 2008, 2009) This is clearly the case for CO<sub>2</sub> emissions that are high with low water levels and low (and negative in case of peat formation) with high water levels. Also CH<sub>4</sub> shows a clear relationship with water levels (Fig. 4). Water levels of more than 20 cm below surface show negligible emissions, whereas values rise steeply with water levels above -20cm.

A more sophisticated methodology using vegetation as GHG proxy is currently being developed for major peatland rewetting projects in Central Europe. This approach is also based on the strong correlation between GHG emissions and mean water levels, but uses vegetation as indicator of water level and therefore as a proxy for annual GHG fluxes. This is possible with a vegetation classification approach that integrates floristic and water level characteristics. The approach (the ‘vegetation form’ concept) departs from the observation that in an environmental gradient (e.g. from dry to wet) some species occur together, whereas others exclude each other (Joosten & Couwenberg, 2009).

Vegetation is well qualified as a proxy for GHG fluxes because it (Joosten & Couwenberg, 2009):

- 1) reflects longer-term water level conditions and thus provides indication on the relevant time scale (GHG fluxes per ha per yr)
- 2) is controlled by the same factors that additionally determine GHG emissions from peatlands (nutrient availability, acidity, land use...)
- 3) is itself directly responsible for part of the GHG emissions by the quality of organic matter it produces (incl. root exudates) and by providing possible bypasses for increased methane emission via aerenchyma (‘shunt species’),
- 4) allows fine-scaled mapping, e.g. on scales 1:2,500 – 1:10,000.

The disadvantages of using vegetation as a proxy are that:

- 1) it cannot be used when the aim of a project is to demonstrate a reduction in greenhouse gas flux with a view to trading on the carbon market. Thus it can only be used when the objective of restoration is to reduce greenhouse gas flux to that of a comparative peatland,
- 2) its slow reaction on environmental changes: it may take 3 years or more before a change in mean annual water level is sufficiently reflected in a change in vegetation composition,
- 3) the necessity to calibrate the approach for different climatic and phytogeographical conditions,

#### 4.5.3.5. Conclusions

Determination of greenhouse gas fluxes particularly CO<sub>2</sub> and CH<sub>4</sub> is critical to assessing the C budget of peatlands. The sink or source strength of these gases will also indicate the state of restoration of a peatland. Enclosure techniques are recommended for the majority of restoration projects at small scales and short time periods due to their accuracy, ease of use and lower cost relative to micrometeorological techniques. However, gas chromatographic analysis of gas samples can be expensive and so analysers such as IRGAs with flow-through enclosures are recommended as alternatives as they can be purchased commercially with loggers for CO<sub>2</sub> measurements. Also, a very high number of measured points are needed to sufficiently describe an ecosystem level. However, for large expansive areas of open homogenous peatland restoration sites such as upland blanket bog where considerable academic interest is present provides support for techniques such as eddy covariance where specialist knowledge is required. Micrometeorological methods provide nondestructive, integrated measurements of gas fluxes over large areas, but generally require large, uniform fetch and may underestimate CO<sub>2</sub> flux as well as not analysing CH<sub>4</sub> or N<sub>2</sub>O flux. Tower-based and airborne eddy flux correlation methods require expensive fast-response sensors and logistical support. Proxies are indirect measures of GHG fluxes that are less expensive and time consuming. Vegetation reflects long term water level, is controlled by the same factors as GHG emission, is partly responsible for GHG emission and allows fine scale mapping. However, it cannot be used to provide an estimate of GHG with a view to trading on the carbon market, it may take a long time to reflect change, and the method must be calibrated with different climatic conditions.

## REFERENCES

- Aaby, B. & Tauber, H (1975) Rates of peat formation in relation to degree of humification and local environment, as shown by studies of a raised bog in Denmark. *Boreas* 4, 1–17.
- Acreman, M.C., Blake, J.R., Booker, D.J., Harding, R.J., Reynard, N., Mountford, J.O. & Stratford, C.J. (2009) A simple framework for evaluating regional wetland ecohydrological response to climate change with case studies from Great Britain. *Ecohydrology* 2, 1-17.
- Allen, R.G., Pereira, L.S., Raes, D. and Smith, M. (1998) FAO Crop evapotranspiration - Guidelines for computing crop water requirements - FAO Irrigation and drainage paper 56. FAO. Rome. ISBN 92-5-104219-5
- Anderson, J.P.E. & Domsch, K.H. (1978) A physiological method for the quantitative measurement of microbial biomass in soils. *Soil Biology Biochem.* 10, 215–221.
- Anderson, P., Tallis, J.H. & Talden, D.W. (1997) Restoring Moorland. Peak District Moorland Management Project. Phase III Report. Peak Park Joint Planning Board, Bakewell.
- Anderson, R., Francez, A-J & Rochefort, L. (2006) The physicochemical and microbiological status of a restored bog in Québec: Identification of relevant criteria to monitor success. *Soil Biol. Biochem.* 38, 1375-1387.
- Anderson, P., Buckler, M. and Walker, J. (2009) Moorland restoration: potential and progress. In: Bonn, A., Allott, T., Hubacek, K. and Stewart, J (eds.) *Drivers of environmental change in uplands*, pp. 432-447. Routledge, London and New York
- Andrássy, I (1984) *Klasse Nematoda*, Akademie-Verlag, Berlin, p. 509.
- Anon (1986) *Monitoring landscape change. Vol. 1. Main report* Huntings Surveys. Borehamwood, UK.
- Anon. (1994) *National Countryside Monitoring Scheme Scotland: Main Report of Findings*. Scottish Natural Heritage, Battleby, UK.
- Aronson, J., Floret, C., Le Floc'h, E., Ovalle, C. & Pontanier, R. (1993) Restoration and rehabilitation of degraded ecosystems in arid and semiarid regions. I. A view from the South. *Restoration Ecology* 1, 8-17.
- Artz, R.E., Chapman, S.J. & Campbell, C.D. (2006) Substrate utilisation profiles of microbial communities in peat are depth dependent and correlate with whole soil FTIR profiles. *Soil Biol. Biochem.* 38, 2958-2962.
- Artz, R.R.E., Chapman, S.J., Siegenthaler, A., Mitchell, E.A.D., Buttler, A., Bortoluzzi, E., Gilbert, d., Yii-Petays, M., Vasander, H. & Francez, A. (2008) Functional microbial diversity in regenerating cutover peatlands responds to vegetation succession. *J. App. Ecol.* 45, 1799-1809.
- Asada, T., Warner, B.G. & Banner, A. (2003) Growth of mosses in relation to climatic factors in a hypermaritime coastal peatland in British Columbia, Canada. *Bryologist* 106, 516-527.
- Aselmann, I. & Crutzen, P.J. (1989) Global distribution of natural freshwater wetlands and rice paddies, their net primary productivity, seasonality and possible methane emissions. *J. Atmos. Chem.* 8, 307-359.

- Ausden, M. (1996) Invertebrates. In W.J. Sutherland (ed.). *Ecological Census Techniques*. Cambridge University Press.
- Austin, M.P. & Heyligers, P.C. (1989) Vegetation survey design for conservation: gradsect sampling of forests in north-eastern New South Wales. *Biol. Conserv.* 50, 13-32.
- Baird A.J. and Gaffney S.W. (2000) Solute movement in drained fen peat: a field tracer study in a Somerset (UK) wetland. *Hydrological Processes* 14, 2489-2503.
- Baldocchi, D.D. (2003) Assessing the eddy covariance technique for evaluating carbon dioxide exchange rates of ecosystems: past, present and future. *Global Change Biol.* 9, 479–492.
- Barber, K.E., Chambers, F.M., Maddy, D., Stoneman, R. & Brew, J.S. (1994) A sensitive high-resolution record of late Holocene climatic change from a raised bog in northern England. *The Holocene* 4, 198-205.
- Bardgett, R.D., Marsden, J.H. & Howard, D.C. (1995) The extent and condition of heather on moorland in the uplands of England and Wales. *Biol. Conserv.* 71, 155-161.
- Bardsley, Crofts & Giles (2001) *The Wetland Restoration Manual*. The Wildlife Trusts.
- Barker, K.R. (1978) Determining population responses to control agents. In: E.I. Zehr (Ed.). *Methods for Evaluating Plant Fungicides, Nematodes and Bactericides*. American Phytopathological Society, St. Paul, Minnesota, USA. Pp. 114-125.
- Beare, M.H., Neely, C.L., Coleman, D.C. & Hargrove, W.L. (1991) Characterization of a substrate-induced respiration method for measuring fungal, bacterial and total microbial biomass on plant residues. *Agri. Eco. & Environ.* 34, 65-73.
- Beckwith C.W., Baird J. and Heathwaite A.L. 2003 Anisotropy and depth-related heterogeneity of hydraulic conductivity in a bog peat. II: modelling the effects on groundwater flow. *Hydrol. Process.* 17, 103–113 (2003)
- Bellamy, P.H., Loveland, P.J., Bradley, R.I., Lark, R.M. & Kirk, G.J.D. (2005) Carbon losses from all soils across England and Wales 1978-2003. *Nature* 437, 245-248.
- Bennie, J.J. & Anderson, K. (2008) Measuring peatland morphology and eco-hydrological condition with laser scanning and spatial statistics. American Geophysical Union, Fall Meeting 2008, abstract #H33B-0996
- Berger, J. (1990) *Environmental restoration: science and strategies for restoring the earth*. Island Press, Washington, D.C.
- Berger, J. (1991) A generic framework for evaluating complex restoration and conservation projects. *Environmental Professional* 13, 254-262.
- Best, E.P.H. & Jacob, F.H.H. (1997) The influence of raised water table levels on carbon dioxide and methane production in ditchdissected peat grasslands in the Netherlands. *Ecol Eng* 8, 129 –144.
- Billesbach, D.P., Fischer, M.L., Torn, M.S. & Berry, J.A. (2004) A portable eddy covariance system for the measurement of ecosystem-atmosphere exchange of CO<sub>2</sub>, water vapour and energy. *Amer. Met. Soc.* 21, 639-650.

- Blackford, J.J. & Chambers, F.M. (1993) Determining the degree of peat decomposition for peat-based palaeoclimatic studies. *International Peat Journal* 5, 7-24.
- Blades, D.C.A. and Marshall, S.A. (1994) Terrestrial arthropods of Canadian peatlands: synopsis of pan trap collections at four southern Ontario peatlands. *Mem. Ent. Soc. Can.* 169, 221-284.
- Bledzki, L.A. & Ellison, A.M. (2003) Diversity of rotifers from northeastern USA bogs with new species records for North America and New England. *Hydrobiologia* 497, 53-62.
- Bloem, J., Hopkins, D.W. & Benedetti, A. (2005) Microbiological methods for assessing soil quality. Cabi Publishing.
- Bochner, B. (1989) Instructions for the use of BiologGP and GN microplates. Biolog Inc., Hayward, CA, USA.
- Bolstad, P.V., Davis, K.J., Martin, J., Cook, B.D. & Wang, W. (2004) Component and whole-system respiration fluxes in northern deciduous forests. *Tree Physiol.* 24, 493–504.
- Bongers, T. (1988) De Nematoden van Nederland. *Natuurhistorische Bibliotheek van de KNNV*, vol. 46, Pirola, Schoorl, p. 408.
- Bonham, C.D. (1989) Measurements of terrestrial vegetation. Wiley, New York.
- Bonnett, S.A.F., Linstead, C., Ross, S. & Maltby, E. (2009) Guidelines for monitoring the success of peatland restoration. Report for Natural England. University of Liverpool.
- Bradshaw, A.D. (1987) The reclamation of derelict land and the ecology of ecosystems. In: W.R. Jordan M.E. Gilpin & J.D. Aber (Eds.). *Restoration ecology: a synthetic approach to ecological research*. Cambridge University Press.
- Bragg, O.M. (2002): Hydrology of peat-forming wetlands in Scotland. *The Science of the Total Environment* 294 (2002) 111–129.
- Bragg, O.M. Hulme, P.D., Ingram, H.A.P., Johnston J.P. and Wilson A.I.A. (1994): A maximum and minimum recorder for shallow water tables, developed for ecohydrological studies on mires, *Journal of Applied Ecology*, 31,589-592.
- Bricker O.P. & Ruggiero, M.A. (1998) Toward a national plan for monitoring environmental resources. *Ecol Applic* 8, 326–329.
- Bridges, E.M. & Harding, D.M. (1971) Micro-erosion processes and factors affecting stage development in the Lower Swansea Valley. In: (D. Brunnsden) *Slopes, Form and Processes*. Institute of British Geographers, London.
- Bridgham, S.D., Updegraff, K. & Pastor, J. (1998) Carbon, nitrogen and phosphorus mineralization in northern wetlands. *Ecology* 79, 1545-1561.
- Bridgham, W.H. & Lamberti, G.A. (2009) Decomposition in wetlands. In E. Maltby & T. Barker (Eds.). *The Wetlands Handbook*. Wiley Blackwell.
- Brock, T.D. (1987) The study of microorganisms *in situ*: Progress and problems. In M. Fletcher, T.R. Gray, & J.C. Jones (eds.). *Ecology of Microbial Communities*. Cambridge University Press.



- Brooks, S.J. (1993) Review of a method to monitor adult dragonfly populations. *J. Brit. Drag. Soc.* 9, 1-4.
- Brown, K.J. & Pasternack, G.B. (2005) A palaeoenvironmental reconstruction to aid in the restoration of floodplain and wetland habitat on an upper deltaic plain, California, USA. *Environmental Conservation* 32, 103-116.
- Brown, A. & Rowell, T.A. (1997) Integrating monitoring with management planning for nature conservation: some principles. *Natur und Landschaft* 72, 502-506.
- Brown, A. F. & Shepherd, K. (1991) Breeding Birds of the South Pennine Moors. JNCC Report No.7.
- British Trust for Ornithology (1995) *Breeding Bird Survey instructions*. Thetford: BTO.
- Budd, J. T. C. (1991): Remote sensing techniques for monitoring land-cover, In: Goldsmith, F. B.: *Monitoring for Conservation and Ecology*, Routledge, Chapman and Hall, New York, London, p. 33-60.
- Bullock, J. (1996) Plants. In W.J. Sutherland (Ed.). *Ecological Census Techniques: A handbook*. Cambridge University Press.
- Burke, M.J.W. & Critchley, C.N.R. (1999) Improving the Cost-effectiveness of the ADAS Plot Method for Monitoring Grassland. Unpublished report to Defra.
- Burns, R.G. & Dick, R.P. (2002) *Enzymes in the environment*. CRC Press
- Busch, D.E. & Trexler, J.C. (2003) *Monitoring Ecosystems: Interdisciplinary Approaches for Evaluating Ecoregional Initiatives*. Island Press.
- Cairns, J.J. (1989) Restoring damaged ecosystems: is predisturbance condition a viable option? *Environmental Professional* 11, 152-159.
- Cairns, J. (1991) Developing a strategy for protecting and repairing self-maintaining ecosystems. *J. Clean Tech. Environ. Sci.* 1, 1-11.
- Campbell, C.D., Chapman, S.J., Cameron, C.M., Davidson, M.S. & Potts, J.M. (2003) A rapid microtiter plate method to measure carbon dioxide evolved from carbon substrate amendments. *Applied and Environmental Microbiology* 69, 3593–3599.
- Cannell, M.G.R., Dewar, R.C. & Pyatt, D.G. (1993) Conifer plantations on drained peatlands in Britain: a net gain or loss of carbon? *Forestry* 66, 353 –369.
- Caraher, D. and Knapp, W.H. (1995) Assessing ecosystem health in the Blue Mountains. P. 34-41 *Silviculture: from the cradle of forestry to ecosystem management*. General technical Report SE-88. Southeast Forest Experimental Station, U.S. Forest Service, Hendersonville, North Carolina.
- Carrera, N., Barreal, M.E., Gallego, P.P. & Briones, M.J.I. (2009) Soil invertebrates control peatland C fluxes in response to warming. *Functional Ecology* 23, 637-648.
- Caseldine, C.J., Baker, A., Charman, D.J. & Hendon, D.(2000) A comparative study of optical properties of NaOH peat extracts : implications for humification studies. *The Holocene* 10, 649-658.
- Casimir, H. (1976) Beitrag zur Hochmoor-Spinnenfauna des Hohen Venns (Hautes Fagnes) Zwischen Nordeifel und Ardennen. *Decheniana (Bonn)* 129, 38–72

- Cavigelli, M.A. Robertson, G.P. & Klug, M.J. (1995) Fatty acid methyl ester (FAME) profiles as measures of soil microbial community structure. *Plant Soil* 70, 99-113.
- Cayford, J.T. & Walker, F. (1991) Counts of male Black Grouse *Tetrao tetrix* in north Wales. *Bird Study* 38, 80-86.
- Chambers, F.M., Mauquoy, D. & Todd, A. (1999) Recent rise to dominance of *Molinia caerulea* in environmentally sensitive areas: new perspectives from palaeoecological data. *Journal of Applied Ecology* 36, 719-733.
- Chapin III, F.S., Schulze, E.D. & Mooney, H.A. (1992) Biodiversity and ecosystem processes. *Trends in Ecology and Evolution* 7, 107-108.
- Chapin III, F.S., Matson, P.A. & Mooney, H.A. (2002) *Principles of Terrestrial Ecosystem Ecology*. Springer, New York.
- Charman, D. (2002) *Peatlands and Environmental Change*. Wiley
- Charman, D.J., Hendon, D. & Woodland, W.A. (2000) The identification of testate amoebae (Protozoa: Rhizopoda) in peats. Technical Guide No. 9, Quaternary Research Association.
- Chen, Y., Senesi, N. & Schnitzer, M. (1977) Information provided on humic substances by E4/E6 ratios. *Soil Sci. Soc. Amer.* 41, 352-358.
- Christensen, S., Ambus, P. & Wienhold, F.G. (1996) Nitrous oxide emissions from an agricultural field: comparison between measurements by flux chamber and micrometeorological techniques. *Atmospheric Environment* 30: 4183-4189.
- Clark, P.E. & Hardegree, S.P. (2005) Estimating vegetation change from repeat landscape photography using angular cover. *Rangeland Ecology & Management* 58, 588-597.
- Clark, J., Lane, S.N., Chapman P.J. and Adamson, J.K. (2008) Link between DOC in near surface peat and stream water in an upland catchment. *Science of The Total Environment*. Volume 404, Issues 2-3, 15 October 2008, Pages 308-315
- Clarkson, B. R., Sorrel, B. K., Reeves, P. N., Champion, P. D., Partridge, T. R. and Clarkson, B. D. (2004): *Handbook for Monitoring Wetland Condition, Coordinated Monitoring of New Zealand Wetlands - A Ministry for the Environment Sustainable Management Fund Project (5105)*, 73 pp.
- Clutterbrook, B. (2004) *Assessment Protocol for the Monitoring of Calluna Burning in Upland Environments*. Unpublished MSc Dissertation, University of Cranfield.
- Clymo, R. S. (1984): The limits to peat bog growth, *Philosophical Transactions of the Royal Society of London*, No 303, Series B, p. 605-654.
- Clymo, R.S. & Duckett, J.G. (1986) Regeneration of *Sphagnum*. *New Phytologist* 102, 589-614.
- Clymo, R.S. (1970) The growth of *Sphagnum* – methods of measurement. *J. Ecol.* 58, 13-49.
- Clymo, R.S. (1983) Peat. In: A.J.P, Gore. (Ed.). *Mires: Swamp, Bog, Fen and Moor, Ecosystems of the World*, Vol. 4A. Elsevier Scientific Publishing Company, pp. 159-224.
- Clymo, R.S., Turunen, J. & Tolonen, K. (1998) Carbon accumulation in peatland. *Oikos* 81, 368-88.

- Cole, L., Bardgett, R.D., Ineson, P. & Adamson, J.K. (2002) Relationships between enchytraeid worms (Oligochaeta), climate change, and the release of dissolved organic carbon from blanket peat in northern England. *Soil Biol. Biochem.* 34, 599-607.
- Coleman, D.C. & Crossley, D.A. (1996) *Fundamentals of Soil Ecology*. Academic Press, San Diego, California, USA.
- Coleman, D.C., Blair, J.M., Elliot, E.T. & Wall, D.H. (1998) Soil Invertebrates. In G.P. Robertson, D.C. Coleman, C.S. Bledsoe, & P. Sollins, (Eds.). *Standard Soil Methods for Long-Term Ecological Research*. LTER. Oxford.
- Commission of the European Communities (1991) *CORINE Biotypes Manual*. Habitats of the European Community. A Method to Identify and Describe Consistently Sites of Major Importance for Nature Conservation. Data Specifications. Part 2. Commission of the European Communities, Luxembourg.
- Corfield, M., Hinton, P., Nixon, T. & Pollard, M. (1996) Preserving archaeological remains *in situ*. Proceedings of the conference of 1<sup>st</sup>-3<sup>rd</sup> April 1996. Museum of Lond. University of Bradford.
- Costanza, R. 1992. Toward an operational definition of ecosystem health. Pp. 239-256 in: Costanza, R., B. Norton and B.. Haskell (eds.) *Ecosystem health: new goals for environmental management*. Island Press, Washington DC.
- Coulson, J.C. & Butterfield, J.E.L. (1985) The invertebrate communities of peat and upland grasslands in the north of England and some conservation implications. *Biol. Conserv.* 34, 197-225.
- Couwenberg, J. & Joosten, H. (1999): Pools as missing links: The role of nothing in the being of mires, In: Standen, V., Tallis, J. H., and Meade, R.: *Patterned Mires and Mire Pools - Origin and Development*; Flora and Fauna, London, p. 87-102.
- Couwenberg, J., Augustin, J., Michaelis, D. & Joosten, H. (2008) Emission reductions from rewetting of peatlands. Towards a field guide for the assessment of greenhouse gas emissions from Central European peatlands. Duene Greifswald / RSPB Sandy.
- Couwenberg, J., Dommain, R & Joosten, H. (2009) Greenhouse gas fluxes from tropical peat swamps in Southeast Asia. *Global Change Biology* (accepted).
- Cragg, J.B. & Ramage, G.R. (1945) Chemotrophic studies on the blowflies *Lucilia sericata* (Mg.) and *Lucilia caesae* (L.). *Parasitology* 36, 168-175.
- Critchley, C.N.R. & Poulton, S.M.C. (1998) A method to optimize precision and scale in grassland monitoring. *Journal of Vegetation Science* 9, 837-846.
- Crofts, A. & Jefferson, R. G. (1999): *Lowland Grassland Management Handbook*, English Nature/The Wildlife Trusts.
- Crowle, A. and McCormack, F (2009) Condition of upland terrestrial habitats. In: Bonn, A., Allott, T., Hubacek, K. and Stewart, J (eds.) *Drivers of environmental change in uplands*, pp. 156-170. Routledge, London and New York
- Curtis, P.S., Vogel, C.S., Gough, C.M., Schmid, H.P., Su, H.B. & Bovard, B.D. (2005) Respiratory losses and the carbon use efficiency of a northern hardwood forest 1999–2003. *New Phytol.* 167, 437–456.

- D'Avanzo, C. (1990) Long Term Evaluation of Wetland Creation Projects. In: (J.A. Kusler & M.E. Kentula) Wetland Creation and Restoration. The Status of the Science. Island Press, Washington D.C.
- Daniels, S.M., Agnew, C.T., Allott, T.E.H., Evans M.G. (2008): Water table variability and runoff generation in an eroded peatland, South Pennines, UK. *Journal of Hydrology*, Volume 361, Issues 1-2, 30 October 2008, p. 214-226
- Danks, H.V. and Rosenberg, D.M. (1987) Aquatic insects of peatlands and marshes in Canada: synthesis of information and identification of needs for research. *Mem. Ent. Soc. Can.* 140, 163-174.
- Danks, H.V. (1996) How to assess insect biodiversity without wasting your time. *Biological Survey of Canada (Terrestrial Arthropods) Document Series No. 5*, 20 pp.
- Dargie, T. (2003) Monitoring and assessing change on the bog restoration surface: a review. In: (R. Meade) *Proceedings of the Risley Bog Restoration Monitoring Workshop, 26-27 February 2003*. English Nature, Peterborough.
- Davidsson, T., Kiehl, K. and Hoffmann, C. C. (2000): Guidelines for monitoring of wetland functioning, *EcoSys*, No 8, p. 5-50.
- Davis, F.W. & Roberts, D. (2000) Stand structure in terrestrial ecosystems. In O.E., Sala, R.B., Jackson, H.A. Mooney, & R.W. Howarth (Eds.). *Methods in Ecosystem Science*. Springer.
- De Mars, H., Wessin, M.J. (1999) Redox potentials in relation to water levels in different mire types in the Netherlands and Poland. *Plant Ecology* 140, 41–51.
- Denmead, O.T. (1979) Chamber systems for measuring nitrous oxide emission from soils in the field. *Soil Sci. Soc. America* 43, 89-95.
- Dennison, D.F. & Hodkinson, J.D. (1984) Structure of the predatory beetle community in a woodland soil ecosystem. IV. Population densities and community composition. *Pedobiologia* 26, 157-170.
- Desjardins, R., Rochette, P. & Puttey, E. (1993) Measurements of greenhouse gas fluxes using aircraft and tower based techniques. In L.A. Harper, A.R. Mosier, J.M. Duxbury & d.e. Rolston (Eds). *Agricultural Ecosystem Effects on Trace Gases and Global Climate Change*. American Society of Agronomy, Crop Science Society of America, Soil Science Society of America, Madison, Wisconsin, USA.
- Dickens, H.E. & Anderson, J.M. (1999) Manipulation of soil microbial community structure in bog and forest soils using chloroform fumigation. *Soil Biol. Biochem.* 31, 2049–2058.
- Disney, R.H.L. (1986) Assessments using invertebrates: posing the problem. In M.B. Ussher (ed.). *Wildlife conservation evaluation*. Chapman & Hall, London. pp. 271-293.
- Dobson, A.P., Bradshaw, A.D. and Baker, A.J.M. (1997) Hopes for the future: restoration ecology and conservation biology. *Science*, 277, 515-522.
- Domenico, P.A. & F.W. Schwartz (1990) *Physical and Chemical Hydrogeology*. John Wiley & Sons, New York.
- Drake, J.A. (1990) Communities as assembled structures: do rules govern pattern? *Trends Ecol. Evol.* 5, 159-164.

- Dryden, R. (1997): Habitat restoration project: Fact sheets and bibliographies, English Nature Research Reports, No 260.
- Earle, D.F. & McGowan, A.A. (1979) Evaluation and calibration of an automated rising plate meter for estimating dry matter yield of pasture. *Aust. J. Exp. Agric. Anim. Husb.* 19, 337-350.
- Edwards, C.A. (1991) The assessment of populations of soil-inhabiting invertebrates. *Agri., Eco., and Environ.* 34, 145-176.
- Edwards, C.A., Grove, T.I., Harwood, R.R. & Pierce Colfer, C.J. (1993) The role of agroecology and integrated farming systems in agricultural sustainability. *Agriculture, Ecosystems and Environment* 46, 99-121.
- Elizinga, C.D., Salzar, D. & Willoughby, J. (1998) Measuring & monitoring plant populations, BLM Technical Reference 1730-1, BLM/RS/ST-98/005+1730, Bureau of Land Management, Natural Science and Technology Center, Lakewood, Colo.
- Ellenberg, H., Arndt, U., Bretthauer, R., Ruthsatz, B. and Steubing, L. (1991): *Biological monitoring - Signals from the environment*, Gate Publication - Vieweg, Braunschweig.
- Elliot, E.T., Heil, J.W., Kelly, E.F. & Monger, H.C. (1998) Soil structural and other physical properties. In G.P. Roberston, D.C. Coleman, C.S. Bledsoe & P. Sollins (Eds). *Standard Soil Methods for Long-Term Ecological Research*. LTER Oxford
- Environment Agency (2003): *A Guide to Monitoring Water Levels and Flows at Wetland Sites*. National Groundwater and Contaminated Land Centre. Environment Agency.
- Environment Canada (2001): *Guidance document for flow measurement of metal mining effluents*. Final report. Environment Canada.
- Erhenfeld, J.G. (2001). Defining the limit of restoration: the need for realistic goals. *Restoration Ecology* 8, 2-9.
- Evans, M. & Warburton, J. (2005) Sediment budget for an eroding peat-moorland catchment in northern England. *Earth Surface Processes and Landforms* 30, 557-577.
- Evans, M.G., Warburton, J. and Yang, J (2006) Sediment budgets for eroding blanket peat catchments: global and local implications of upland organic sediment budgets. *Geomorphology* 79, 45-57.
- Evans, R. (1977) Overgrazing and soil erosion on hill pastures with particular reference to the Peak District. *Journal of the British Grassland Society* 32, 65-76.
- Eyre, M.D. & Woodward, J. (1996) Spiders in environmental surveillance and site assessment. *Environmental Monitoring, Surveillance and Conservation using Invertebrates*. In: M.D, Eyre (Ed.), EMS Publications, Newcastle upon Tyne, pp. 26-28.
- Eyre, M.D. (1996) *Environmental Monitoring, Surveillance and Conservation using Invertebrates*. EMS Publications, Newcastle upon Tyne.
- Fahey, T.J. & Knapp, A.K. (2007) *Principles and standards for measuring primary production (The long-term ecological research network)*. Oxford University Press.

- Field, M. (1983) The meteorological office rainfall and evaporation calculation system -- MORECS, Agricultural Water Management, vol. 6(2-3), pages 297-306, May.
- Findlay, R.H., Trexler, M.B. Guckert, J.B. & White, D.C. (1990) Laboratory study of disturbance in marine sediments: response of a microbial community. Marine Ecology Progress Series 62, 121-133.
- Finnamore, A.T. (1994) Hymenoptera of the Wagner Natural Area, a boreal spring fen in central Alberta. Mem. Ent. Soc. Can. 169, 181-220.
- Fisk, M.C., Ruether, K.F. & Yavitt, J.B. (2003) Microbial activity and functional composition among northern peatland ecosystems. Soil Biol. Biochem. 35, 591-602.
- Floodplain Meadows Partnership (undated). Advisory Protocol No. 2. Hydrological Monitoring ([www.floodplainmeadows.org.uk](http://www.floodplainmeadows.org.uk), accessed March 2009)
- Fowler, J., Cohen, L. & Jarvis, P. (1978) Practical statistics for field biology. Wiley
- Francez, A.J. (1981) Rotiferes de quelques tourbières d'Auvergne. Ann. Stn. Biol. Besse Chandesse 15, 276-285.
- Francez, A.J. (1987) Successions ecologiques dans les tourbières: le peuplement de rotifers du lac tourbière de Chambedaze (Puy-de-dome, Fance). Bull. Ecol. 18, 31-38.
- Francez, A.J. (1988) Le peuplement de rotifers libres de deux lacs-tourbières du Pay-de-Dome (France). Vie Milieu 38, 281-292.
- Francez, A.J., Gogo, S. & Josselin, N. (2000) Distribution of potential CO<sub>2</sub> and CH<sub>4</sub> production, denitrification and microbial biomass C and N in the profile of a restored peatland in Brittany (France). European Journal of Soil Biology 36, 161-168.
- Frankel, O.H., Brown, A.H.D. & Burdon, J.J. (1995): The conservation of plant biodiversity. Cambridge University Press, Cambridge.
- Freckman, D.W. & Baldwin, J.G. (1990) Soil Nematoda, pp. 155-200. In: D.L. Dindal (ed.). Soil Biology Guide. Wiley, New York, USA.
- Freeman, C. (2001) An enzymic 'latch' on a global carbon store. Nature 409, 149.
- Freeman, C., Fenner, N., Ostle, N., Kang, H., Dowrick, D.J., Reynolds, B., Lock, M.A., Sleep, D. Hughes, S. & Hudson, J. (2004) Export of dissolved organic carbon from peatlands under elevated carbon dioxide levels. Nature 430, 195-198.
- Garland, J.L. & Mills, A.L. (1991) Classification and characterization of heterotrophic microbial communities on the basis of patterns of community-level-sole-carbon-source-utilization. Appl Environ Microbiol 57, 2351-2359.
- Gaskin, G.J. & Miller, J.D. (1996) Measurement of soil water content using simplified impedance measuring technique. J. Agric. Eng. Res. 63, 153-160.
- Gauch, H.G., Jr. (1982) Multivariate analysis in community ecology. Cambridge University Press. Cambridge, England.

- Gibbons, D.W., Hill, D. & Sutherland, W.J. (1996) Birds. In: W.J. Sutherland (Ed.). *Ecological Census Techniques*. Cambridge University Press.
- Gilbert, D. & Mitchell, E.A.D. (2006) Microbial diversity in *Sphagnum* peatlands. In: I.P. Martini, A. Martinez Cortizas & W. Chesworth. *Peatlands: Evolution and records of environmental and climate changes*. *Developments in Earth Surface Processes*. Elsevier Science.
- Gillison, A.N. and K.R.W. Brewer (1985) The use of gradient directed transects or gradsects in natural resource survey. *Journal of Environmental Management*. 20:103–127.
- Gilman, K. (1994), *Hydrology and Wetland Conservation*, Institute of Hydrology Water Series, Wiley, Chichester.
- Gilvear and Bradley, (2000): *Hydrological Monitoring and Surveillance for Wetland Conservation and Management; a UK Perspective*. *Physics and Chemistry of the Earth (B)*, Vol. 25, No. 7-8, pp. 571-588, 2000
- Gilvear, D.J., Sadler, P.J.K., Tellam, J.H. and Lloyd, J.W. (1997) Surface water processes and groundwater flow within a hydrologically complex floodplain wetland, Norfolk Broads, UK *Hydrology and Earth Systems Sciences*, 1, 1-21.
- Girard, M., Lavoie, C. & Theriult, M. (2002) The regeneration of a highly disturbed ecosystem. A mined peatland in southern Quebec. *Ecosystems* 5, 274-300.
- Givelet, N et al. (2004) Suggested protocol for collecting, handling and preparing peat cores and peat samples for physical, chemical, mineralogical and isotopic analyses *J. Environ. Monit.* 6, 481-92
- Godron, M. and R.T.T. Forman (1983) Landscape modification and changing ecological characteristics. In: H.A. Mooney and M. Godron (editors). *Disturbance and ecosystems: components of response*. Springer-Verlag, pp. 12–28. New York, USA.
- Goldsmith, F.B. (1991) *Monitoring for Conservation and Ecology*. Chapman and Hall, New York.
- Gore, A.J.P. (1983) *Ecosystems of the World 4B. Mires, Swamps, Bog, Fen and Moor*. Regional Studies. Elsevier Scientific, Amsterdam.
- Gorham, E. (1991) Northern peatlands: Role in the carbon cycle and probable responses to climatic warming. *Ecological Applications* 1, 182-195.
- Gorham, E. & Rochefort, L. (2003) Peatland restoration: a brief assessment with special reference to *Sphagnum* bogs. *Wetland Ecology and Management* 11, 109–119.
- Goulden, M.L., Munger, J.W. & Wofsy, S.C. (1996) Exchange of carbon dioxide by a deciduous forest: response to interannual climate variability. *Science* 271: 1576-1579.
- Greenslade, P.J.M. (1964) Pitfall trapping as a method for studying populations of Carabidae (Coleoptera). *Journal of Animal Ecology* 33, 301-310.
- Greenwood, J. J. D. (1996) Basic techniques. In: W. J. Sutherland (Ed.). *Ecological Census Techniques* Cambridge: Cambridge University Press. pp. 11–110.
- Grieg-Smith, P. (1983) *Quantitative Plant Ecology*. 3<sup>rd</sup> Edition. Blackwell Scientific Publications, Oxford.

- Grossman, D.H., Goodin, K.L., Li, X., Faber-Langendoen, D., Anderson, M., Bourgeron, P. & Vaughn, R. (1994) *Field methods for Vegetation Mapping*. NBS/NPS Vegetation Mapping Program. The Nature Conservancy, Arlington, VA, and Environmental Systems Research Institute, Redlands, CA, US.
- Guckert, J.B., Antworth, C.P., Nichols, P.D. & White, D.C. (1985) Phospholipid, ester-linked fatty acid profiles as reproducible assays for changes in prokaryotic community structure of estuarine sediments. *FEMS Micro. Ecol.* 31, 147-158.
- Harvey, A.M. (1974) Gully erosion and sediment yield in the Howgill Fells, Westmorland. In: (K.J. Gregory & D.E. Walling) *Fluvial Processes in Instrumented Watersheds*. Institute of British Geographers, London.
- Healy, R.W., Strigel, R.G., Russell, T.F., Hutchinson, G.L. & Livingston, G.P. (1996) Numerical evaluation of static-chamber measurements of soil-atmosphere gas exchange: identification of physical processes. *Soil Science Society of America Journal* 60, 740-749.
- Hellawell, J.M. (1991) Development of rationale for monitoring. Pg. 1-14 in Goldsmith, B. (ed.) *Monitoring for Conservation and Ecology*. Chapman and Hall, London.
- Hendon, D. & Charman, D.J. (1997) The preparation of testate amoebae (Protozoa: Rhizopoda) samples from peat. *The Holocene* 7, 199–205.
- Hendon, D., Charman, D.J. and Kent, M. (2001) Palaeohydrological records derived from testate amoebae analysis from peatlands in northern England: within-site variability, between-site comparability and palaeoclimate implications. *The Holocene* 11, 127-148.
- Herben T. (1996) Permanent plots as tools for plant community ecology. *Journal of Vegetation Science* 7, 195-202.
- Hilbert, D.W., Roulet, N. & Moore, T.R. (2000) Modeling and analysis of peatlands as dynamical systems. *J. Ecol.* 88, 230–42.
- Hilderbrand, R.H., Watts, A.C. & Randle, A.M. (2005) The myths of restoration ecology. *Ecology and Society* 10, 19.
- Hill, C.J., Gillison, A.N. & Jones, R.E. (1992) The spatial distribution of rain forest butterflies at three sites in north Queensland, Australia. *J. Trop. Ecol.* 8, 37-46.
- Hobbs, R.J. (1994) Dynamics of vegetation mosaics: can we predict responses to global change? *Ecoscience* 1, 346-356.
- Hobbs, R.J. & Mooney, H.A. (1993) Restoration ecology and invasion: implications for conservation. *Conservation Biology* 6, 324-337.
- Hobbs, R.J. & Norton, D.A. (1996) Towards a conceptual framework for restoration ecology. *Restoration Ecology* 4, 93-110.
- Hodgson, J.M. (1997) *Soil Survey Field Handbook. Describing and Sampling Soil Profiles*. Technical Monograph No. 5. Soil Survey and Land Research Centre, Cranfield University, Silsoe.
- Holden, J. & Burt, T.P. (2003) Hydraulic conductivity in upland blanket peat: measurement and variability. *Hydrological Processes* 17, 1227-1237.



- Holden, J. (2004) Hydrological connectivity of soil pipes determined by ground-penetrating radar tracer detection. *Earth Surface Processes and Landforms*, 29 (4). pp. 437-442.
- Holden, J., Shotbolt, L., Bonn, A., Burt, T.P., Chapman, P.J., Dougill, A.J., Fraser, E.D.G., Hubacek, K., Irvine, B., Kirkby, M.J., Reed, M.S., Prell, C., Stagl, S., Stringer, L.C., Turner, A. and Worrall, F. (2007) Environmental change in moorland landscapes. *Earth-Science Reviews* 82, 75-100.
- Holden J. (2009) Flow through macropores of different size classes in blanket peat. *Journal of Hydrology* 364 (2009) 342–348.
- Holl, K. & Cairns, J., Jr. (1995) Landscape indicators in ecotoxicology. In: D.J. Hoffman, B.A. Rattner, G.A. Burton & J. Cairns, Jr. (Eds.). *Handbook of ecotoxicology*. Boca Raton, FL. Lewis Publishers.
- Holl, K. & Cairns, J. (2002) Monitoring and appraisal. In: M.R. Perrow & A.J. Davy (Eds.). *Handbook of ecological restoration – Principles of restoration*. Cambridge University Press.
- Höll, B.S., Fiedler, S., Jungkunst, H.F., Kalbitz, K., Freibauer, A., Drösler, M. & Stahr, K. (in press) Characteristics of dissolved organic matter following 20 years of peatland restoration. *Sci. Tot. Env.*
- Holland, E.A., Robertson, G.P., Greenberg, J., Groffman, P.M., Boone, R.D. and Gosz, J.R. (1998) Soil CO<sub>2</sub>, N<sub>2</sub>O and CH<sub>4</sub> exchange. In G.P. Robertson, D.C. Coleman, C.S. Bledsoe & P. Sollins (Eds). *Standard Soil Methods for Long-Term Ecological Research*. LTER Oxford
- Holling, C.S. (1973) Resilience and stability of ecological systems. *Review of Ecology and Systematics* 4, 1-23.
- Holling, C.S. & Meffe, G.K. (1996) Command and control and the pathology of natural resource management. *Conservation Biology* 10, 328-337.
- Hollis, G.E. and Thompson, J.R. (1998): Hydrological Data for Wetland Management Water and Environment Journal 12(1) 9-17
- Holmes, P.R., Boyce, D.C., Reed, D.K. (1991a) The Welsh Peatland Invertebrate Survey: Montgomery. Countryside Council for Wales, Bangor.
- Holmes, P.R., Boyce, D.C., Reed, D.K. (1991b) The Welsh Peatland Invertebrate Survey: Ceredigion. Countryside Council for Wales, Bangor.
- Holmes, P.R., Boyce, D.C., Reed, D.K. (1992) The Welsh Peatland Invertebrate Survey: Merioneth. Countryside Council for Wales, Bangor.
- Holmes, P. R., D. C. Boyce, and D. K. Reed. (1993) The ground beetle (Coleoptera: Carabidae) fauna of Welsh peatland biotypes: factors influencing the distribution of ground beetles and conservation implications. *Biological Conservation* 63, 153–161.
- Holmes, P.R., Boyce, D.C., Reed, D.K. (1995a) The Welsh Peatland Invertebrate Survey: Anglesey. Countryside Council for Wales, Bangor.
- Holmes, P.R., Boyce, D.C., Reed, D.K. (1995b) The Welsh Peatland Invertebrate Survey: Denbigh. Countryside Council for Wales, Bangor.
- Holmes, P.R., Boyce, D.C., Reed, D.K. (1995c) The Welsh Peatland Invertebrate Survey: Caernarvon. Countryside Council for Wales, Bangor.

- Holopainen, J. K. (1990) Influence of ethylene glycol on the numbers of carabids and other soil arthropods caught in pitfall traps. In: Stork, N. E. (Ed) *The role of ground beetles in ecological and environmental studies*. pp. 339–341. Intercept Ltd., Andover, Hampshire, United Kingdom.
- Huisman, J., Olff H. & Fresco L.F.M. (1993) A hierarchical set of models for species response analysis. *Journal of Vegetation Science* 4, 37-46.
- Hurlbert, S. H. (1971) The non-concept of species diversity: A critique and alternative parameters. *Ecology* 52, 577–586.
- Hutchings, N.J., Phillips, A.H. & Dobson, R.C. (1990) An ultrasonic rangefinder for measuring the undisturbed surface height of continuously grazed grass swards. *Grass Forage Sci.* 45, 119-128.
- Hutchings, M.J. (1991) Monitoring plant populations: census as an aid to conservation. In: Goldsmith, F.B. (ed.): *Monitoring for conservation and ecology*. Chapman & Hall, London: 61-76.
- Hutchinson, G.L. & Livingston, G.P. (1993) Use of chamber systems to measure trace gas fluxes. In L.A. Harper, A.R. Mosier, J.M. Duxbury, & D.E. Rolston (Eds) *Agricultural Ecosystem Effects on Trace Gases and Global Climate Change*. American Society of Agronomy, Crop Science Society of America, Soil Science Society of America, Madison, Wisconsin, USA.
- Imeson, A.C. (1974) The origin of sediment in a moorland catchment with particular reference to the role of vegetation. In: (K.J. Gregory & D.E. Walling) *Fluvial Processes in Instrumented Watersheds*. Institute of British Geographers, London.
- Immirzi, C.P. & Maltby, E with Clymo, R.S. (1992) *The Global Status of Peatlands and their Role in Carbon Cycling. A report for Friends of the Earth by the Wetland Ecosystems Research Group, Department of Geography, University of Exeter. Friends of the Earth, London.*
- Ingham, R.E., Trofymow, J.A. & Coleman, D.C. (1985) Interactions of bacteria, fungi, and their nematode grazers: effects on nutrient cycling and plant growth. *Ecol. Monogr.* 55, 119-140.
- Insam, H. & Goberna, M. (2004) Use of Biolog® for the Community Level Physiological Profiling (CLPP) of environmental samples. *Molecular Microbial Ecology Manual, Second Edition* 4.01, 853-860.
- Ivanov, N., Boissard, P., Chapron, M. & Valery, P. (1994) Estimation of the height and angles of orientation of the upper leaves in the maize canopy using stereovision. *Agronomie* 14, 1183-1194.
- Ivanov, K. E. (1981): *Water movement in mirelands*, Academic Press, London.
- Jackson, T. J., D. M. LeVine, C. T. Swift, T. J. Schmutge, and F. R. Schiebe (1995) Large area mapping of soil moisture using the ESTAR passive microwave radiometer. *Remote Sens. Environ.* 53, 27-37.
- Jackson, D.L. (2000) *Guidance of the Interpretation of the Biodiversity Broad Habitat Classification (Terrestrial and Freshwater Types): Definitions and the Relationship with other Habitat Classifications*. JNCC Report No. 307. JNCC, Peterborough.
- Janssens, I.A., Kowalski, S.A. & Ceulemans, R. (2001) Forest floor CO<sub>2</sub> flux estimates by eddy covariance and chamber-based model. *Agric. For. Meteorol.* 102, 61–69.
- Jerman, V., Metje, M., Mandié-Mulec, I. & Frenzel, P. (2009) Wetland restoration and methanogenesis: the activity of microbial populations and competition for substrates at different temperatures. *Biogeosciences* 6, 1127-1138.

- JNCC (2004a) Guidance for Common Standards Monitoring (CSM). Joint Nature Conservation Committee, Peterborough.
- JNCC (2004b) Common standards monitoring guidance for lowland wetland habitats. Joint Nature Conservation Committee, Peterborough.
- JNCC (2007) Handbook for Phase 1 habitat survey - a technique for environmental audit, Revised reprint 2003, reprinted 2007.
- JNCC (2008) Common standards monitoring guidance for upland habitat. Joint Nature Conservation Committee, Peterborough.
- Joergensen, R.G. (1995) Microbial biomass: the fumigation method In K. Alef & P. Nannipieri (eds.). *Methods in Applied Soil Microbiology and Biochemistry*. Academic Press, London,UK.
- Johnsgaard, P.A. (1994) *Arena Birds: Sexual Selection and Behaviour*. Smithsonian Institution Press, Washington D.C.
- Johnson, B.R. (1997) Monitoring Peatland Rehabilitation. In: (L. Parkyn, R.E. Stoneman & H.A.P. Ingram) *Conserving Peatlands*. CAB International, Wallingford.
- Joosten, H. (1993): Denken wie ein Hochmoor: Hydrologische Selbstregulation von Hochmooren und deren Bedeutung für Wiedervernässung und Restauration, *TELMA*, 23,= Deutsche Gesellschaft für Moor- und Torfkunde (DGMT), Hannover, p. 95-115.
- Joosten, H. Couwenberg, J. (2009) Are emissions reductions from peatlands MRV-able? *Wetlands International*
- Jonczyk, J., Wilkinson, M., Rimmer, D. & Quinn, P. (2009) *Peatscapes: Monitoring of hydrology and water quality at Geltside and Priorside*. Report of Phase 1. Newcastle University.
- Jones, J.C. & Reynolds, J.D. (1996) Environmental variables. In: W.J. Sutherland (ed.) *Ecological Census Techniques: a Handbook*. pp. 281-316. Cambridge University Press, Cambridge.
- Jongman, R.H.G., Ter Braak, C.J.F. & Van Tongeren, E.F.R. (eds.) (1987) *Data analysis in community and landscape ecology*. Pudoc, Wageningen
- Jury, W.A., J. Letey & T. Collins (1982) Analysis of chamber methods used for measuring nitrous oxide fluxes. *Soil. Sci. Soc. Am. J.* 46:250–256.
- Kaiser, E.A., Mueller, T., Joergensen, R.G., Insam, H. & Heinemeyer, O. (1992) Evaluation of methods to estimate the soil microbial biomass and the relationship with soil texture and organic matter. *Soil Biol. Biochem.* 24, 675-683.
- Kanemasu, E.T., Powers, W.L. & Sij, J.W. (1974) Field chamber measurements of CO<sub>2</sub> flux from soil surface. *Soil Sci.* 118, 233–237.
- Kang, H & Freeman, C. (1999) Phosphatase and arylsulphatase activities in wetland soils: annual variation and controlling factors. *Soil Biol. Biochem.* 31, 449-454.
- Keener, R.D. & Needham, K. (1999) *Burns bog ecosystem review: Invertebrate component final report*. University of British Columbia. Report for Delta Fraser Properties Partnership

- Kershaw, K.A. & Looney, J.H.H. (1983) *Quantitative and Dynamic Plant Ecology*. Edward Arnold, London.
- Kirby, P. (1992) *Habitat Management for Invertebrates. A Practical Handbook*. RSPB, Sandy.
- Kilian, M.R., van der Plicht, J. & van Geel, B. (1995) Dating raised bog: new aspects of AMS C-14 wiggle matching, a reservoir effect and climatic change. *Quat Sci Rev* 14, 959–66.
- Kilian, M.R., van Geel, B. & van der Plicht, J. (2000) C-14 AMS wiggle matching of raised bog deposits and models of peat accumulation. *Quat Sci Rev* 19, 1011–33.
- Kirkham, F.W., Fowbert, J.A., Parkin, A.B., Darlaston, M. & Glaves, D.J. (2005) Moorland vegetation monitoring in the Dartmor ESA 1994-2003. ADAS Report to DEFRA. Project MA01016.
- Kivimäki, S.K., Yli-petäys, M. & Tuittila, E. (2008) Carbon sink function of sedge and *Sphagnum* patches in a restored cut-away peatland: increased functional diversity leads to higher production. *J. Appl. Ecol.* 45, 921-929.
- Klavins, M., Sire, J., Purmalis, O. & Melecis, V. (2008) Approaches to estimating humification indicators for peat. *Mires and Peat*, Vol. 3, 1-15
- Klötzli, F. & Grootjans, A.P. (2001) Restoration of natural and semi-natural wetland systems in Central Europe: progress and predictability of developments. *Restoration Ecology* 9, 209-219.
- Knapp R. (1984) Sampling methods and taxon analyses in vegetation science. *Handbook of vegetation science* 4. Dr. W. Junk Publishers, The Hague.
- Kondolf, G.M. (1995) Five elements for effective evaluation of stream restoration. *Restoration Ecology* 3, 133-136.
- Kooijman, A.M. & Kanne, D.M. (1993) Effects of water chemistry, nutrient supply and intraspecific interactions on the replacement of *Sphagnum subnitens* by *S. fallax* in fens. *J. Bryology* 13, 431-438.
- Kowalski, K.P. & Wilcox, D.A. (1999) Use of historical and geospatial data to guide the restoration of a Lake Erie coastal marsh. *Wetlands* 19(4), 858-868.
- Kozlovskaja, L.S. (1974) The effect of drainage on the change in the biological activity of forest peat soils. In: *Proceedings of the International Symposium on Forest Drainage*, Jyväskylä-Oulu, Finland. IPS, Helsinki, Finland, pp. 57±62.
- Kupryjanowicz, J., Hajdamowicz, I., Stankiewicz, A. & Starega, W. (1998) Spiders of some raised peat bogs in Poland. In: Selden, P.A. (Ed.), *Proceedings of the 17th European Colloquium of Arachnology*, Edinburgh 1997. British Arachnological Society, Burnham Beeches, Bucks, pp. 267–272.
- Kusler, J. A. and M. E. Kentula (1990) Executive summary, pp. xvii-xxv. In Kusler, J. A. and M. E. Kentula (eds.) *Wetland Creation and Restoration: the Status of the Science*. Island Press, Washington, D.C.
- Laggoun-Défarge, F., Mitchell, E., Gilbret, D., Disnar, J.R., Comont, L., Warner, B.G. & Buttler, A. (2008) Cut-over peatland regeneration assessment using organic matter and microbial indicators (bacteria and testate amoebae). *J. Appl. Ecol.* 45, 716-727.

- Laiho, R., Penttilä, T. & Laine, J. (2004) Variation in soil nutrient concentrations and bulk density within peatland forest sites. *Silva Fennica* 38, 29–41.
- Lane, S.N., Brookes, C.J., Hardy, R.J., Holden, J., James, T.D., Kirkby, M.J., McDonald, A.T., Tayefi, V. and Yu Dapeng (2003) Land management, flooding and environmental risk: new approaches to a very old question. Forthcoming in Proceedings of Paper presented at CIWEM National Conference, September 2003.
- Lapitan, R.L., Wanninkhof, R. & Mosier, A.R. (1999) Methods for stable gas flux determination in aquatic and terrestrial systems. *Developments in Atmospheric Science* 24, 29-66.
- Large, A.R.G., Mayes, W.M., Newson, M.D. & Parkin, G. (2007) Using long-term monitoring of fen hydrology and vegetation to underpin wetland restoration strategies. *Applied Veg. Sci.* 10, 417-428.
- Latter, P.M. & Howson, G. (1978) Studies on the microfauna of blanket bog with particular reference to Enchytraeidae II. Growth and survival of *Cognettia sphagnetorum* on various substrates. *J. Anim. Ecol.* 47, 425±449.
- Launiainen, S., Rinne, J., Pumpanen, J., Kulmala, L., Kolari, P., Kerönen, P., Silvola, E., Pohja, T., Hari, P. & Vesala, T. (2005) Eddy covariance measurements of CO<sub>2</sub> and sensible and latent heat fluxes during a full year in a boreal pine forest trunk-space. *Boreal Environ. Res.* 10, 569–588.
- Lavoie, C., Zimmerman, C. & Pellerin, S. (2001) Peatland restoration in southern Quebec (Canada): a paleoecological perspective. *Geoscience* 8(2), 247-258.
- Le Duc M.G., Pakeman R.J. & Marrs R.H. (2003) Changes in the rhizome system of bracken subjected to long-term experimental treatment. *Journal of Applied Ecology* 40, 508–522.
- Lenschow, D.H. (1995) Micrometeorological techniques for measuring biosphere-atmosphere trace gas exchange. pp 126-163 in P.A. Matson & R.C. Harriss (Eds.). *Biogenic Trace Gases: Measuring Emissions from Soil and Water*. Blackwell Science. Cambridge, Massachusetts, USA.
- Lindsay, R & Ross, S. (1993) Monitoring of peat bog systems. In: (G. Aubrecht, G. Dick & C. Prentice) *Monitoring Ecological Change in Wetlands of Middle Europe*. IWRB Publication No. 30, Slimbridge.
- Lindsay, R.A. (1977) Glasson Moss and the 1976 Fire. Unpublished report to the Nature Conservancy Council.
- Livingston, G.P. and Hutchinson, G.L. (1995) Enclosure-based measurements of trace gas exchange: applications and sources of error. pp. 14-51 in P.A. Matson & R.C. Harriss (Eds.). *Biogenic Trace Gases: Measuring Emissions from Soil and Water*. Blackwell Science. Cambridge, Massachusetts, USA.
- Loomis, J. & Patten, D. (2005) Values and goals of river and lake restoration. UCOWR Annual conference. *River and Lake Restoration: Changing Landscapes*, Portland, ME.
- Loudermilk, E.L., Singhania, A., Fernandez, J.C., Hiers, J.K., O'Brien, J.J., Cropper Jr., W.P., Slatton, K.C. and Mitchell, R.J. 2007. Application of ground-based LIDAR for fine-scael forest fuel modelling. In: Butler, Bret W.; Cook, Wayne, comps. *The fire environment-innovations, management, and policy; conference proceedings*. 26-30 March 2007; Destin, FL. Proceedings RMRS-P-46CD. Fort Collins, CO: U.S. Department of Agriculture, Forest Service, Rocky Mountain Research Station. CD-ROM. p. 515-523.
- Lopez-Buendia, A.M. (1998) A new method for the preparation of peat samples for petrographic study by transmitted and reflected light microscopy. *J. Sed. Res.* 68, 214-217.

- Luh, H-K & Pimm, S. L. (1993) The assembly of ecological communities: a minimalist approach. *J. Animal Ecology* 62, 749–765.
- Luff, M.L. & Woiwod, I.P. (1995) Insects as indicators of land-use change. In: *Insects in a changing environment*, edited by R. Harrington & N.E. Stork, 399- 422. London: Academic Press.
- Luken, J.O. (1990) Directing ecological succession. Chapman and Hall, New York.
- Magurran, A.E. (2004) Measuring Biological Diversity. Blackwell, Oxford.
- Malloch, A.J.C. (1992) MATCH – a computer programme to aid the assignment of vegetation to the communities and sub-communities of the National Vegetation Classification. University of Lancaster, Lancaster.
- Maltby, E., Immirzi, C.P. & McLaren, D.P. (1992) Do not disturb! Peat bogs and the greenhouse effect. Friends of the Earth, London.
- Maltby, E. (1997) Wetland Soils: A perspective on scientific and management challenges. *Seesoils Journal* 12: 4-12.
- Maltby, E & Barker, T. (2009) The Wetlands Handbook. Wiley-Blackwell.
- Malterer, T.J., Verry, E.S. & Erjavec, J. (1992) Fiber content and degree of decomposition in peats: review of national methods. *Soil Science Society of America Journal* 56, 1200–11.
- Manners, G. (2009) Fylingdales Burn Site Monitoring Programme 2005-2008. End of Year 4 Report. Unpublished report by MAB Environment and Ecology Ltd. to the North York Moors National Park Authority.
- Markkula, I. (1981) Vertical distribution of soil animals in a virgin and drained raised bog, *Suo* 32: 26±129. (in Finnish with English summary).
- Markkula, I. (1982) Effect of drainage and NPK-fertilization on soil animals of a raised bog. *Suo* 33, 5±63. (in Finnish with English summary).
- Marshall, S.A. & Finnamore, A.T. (1994) Peatland arthropods introduction. *Mem. Ent. Soc. Canada* **169**: 3-5.
- Martens, R. (1995) Current methods for measuring microbial biomass C in soil: Potentials and limitations. *Biol. Fertil. Soils* 19, 87-99.
- Martini, I.P., Martinez Cortizas, A. & Chesworh, W. (2006) Peatlands: Evolution and records of environmental and climate changes. *Developments in Earth Surface Processes*. Elsevier Science.
- Maskell, L. C.; Norton, L. R.; Smart, S. M.; Scott, R.; Carey, P. D.; Murphy, J.; Chamberlain, P. M.; Wood, C. M.; Barr, C. J.; Bunce, R. G. H.. (2008) *Countryside Survey. Vegetation Plots Handbook*. NERC/Centre for Ecology & Hydrology, 64pp. (CS Technical Report No.2/07, CEH Project Number: C03259)
- Mathema, A.B. (2005) Monitoring of peat bog restoration. MSc Thesis. International Institute for Geo-Information Science and Earth Observation. Enschede, The Netherlands.
- Matson, P. & Goldstein, A. (2000) Biogenic trace gas exchanges. In O.E., Sala, R.B., Jackson, H.A. Mooney, & R.W. Howarth (Eds.). *Methods in Ecosystem Science*. Springer.

- Matthias, A.D., D.N. Yarger & R.S. Weinbeck (1978) A numerical evaluation of chamber methods for determining gas fluxes. *Geophys. Res. Lett.* 5:765–768.
- Mawby, F.J. (2003) South Solway Mosses National Nature Reserve: A review of damming practice since 1979. In: (R. Meade) *Proceedings of the Risley Bog Restoration Monitoring Workshop, 26-27 February 2003*. English Nature, Peterborough.
- McGeoch, M.A. (1998) The selection, testing and application of terrestrial insects as bioindicators. *Biological Reviews* 73, 181–201.
- McMorrow, J.M., Al-Roichdi, A., Evans, M.G. & Cutler, M.E. (2004) The estimation of humification of exposed upland peat from HyMaP AND asd SPECTRA. *Airborne Imaging Spectroscopy Workshop, Bruges, 8 October 2004*.
- McSorley, R. (1987) Extraction of nematodes and sampling methods. In: R.H. Brown & B.R. Kerry (eds.). *Principles and Practices of Nematode Control in Crops*. Academic Press, London, UK. Pp. 13-48.
- Meisterfeld, R. (2000a) Order Arcellinida Kent, 1880. *The Illustrated Guide to the Protozoa* (eds J.J. Lee, G.F. Leedale & P. Bradbury), Vol. 2, pp. 827–860. Society of Protozoologists, Lawrence, KS.
- Meisterfeld, R. (2000b) Testate amoebae with filopodia. *The Illustrated Guide to the Protozoa* (eds J.J. Lee, G.F. Leedale & P. Bradbury), Vol. 2, pp. 1054–1084. Society of Protozoologists, Lawrence, KS.
- Merrett, P. & Murphy, J.A. (2000) A revised check-list of British spiders. *Bulletin of the British Arachnological Society* 11, 345–358.
- Michener, W.K. & Houhoulis, P.F. (1997) Detection of vegetation changes associated with extensive flooding in a forested ecosystem. *Photogrammetric Engineering and Remote Sensing* 63, 1363-1374.
- Milligan, A.L., Marrs, R.H. & Putwain, P.D. (1997) Control of *Molinia caerulea* (L.) Moench in upland Britain. *British Crop Protection Conference (Weeds) 1997*, 679-680.
- Milly P. C. D., Betancourt J. Falkenmark M. Hirsch R.M. Kundzewicz Z.W., Lettenmaier D.P. and Stouffer R.J. 2008. Stationarity Is Dead: Whither Water Management? *Science* 319(5863) 573–574.
- Milne, R. & Brown, T.A. (1997) Carbon in the vegetation and soils of Great Britain. *J Environ Manage* 49, 413–433.
- Milton, E.J., Hughes, P.D., Anderson, K., Schultz, J., Hill, C.T. & Lindsay, R. (2004) Remote sensing condition categories on lowland raised bogs in the United Kingdom. Part 1: Development and testing methods. *Proceedings of the Peterborough Remote Sensing Workshop*. English Nature.
- Milton, E J, Hughes, P D, Anderson, K, Schulz, J, Lindsay, R, Kelday, SB, and Hill, C T. (2005) Remote sensing of bog surfaces *JNCC Report No. 366*.
- Mitchley, J., Burch, F., Buckley, P. and Watt, T. A. (2000): *Habitat restoration monitoring handbook, English Nature Research Reports, 378*, English Nature, Peterborough, 26 pp. excl. Appendix 22 pp.
- Mitsch, W.J. & Gosselink, J.G. (2000) *Wetlands*. Third Edition. Wiley.
- Moncrieff, J.B., Jarvis, P.G. & Valentini, R. (2000) Canopy fluxes. In O.E. Sala, R.B. Jackson, H.A. Mooney & R.W. Howarth (2000) *Methods in Ecosystem Science*. Springer.
- Moore, N.W. & Corbet, P.S. (1990) Guidelines for monitoring dragonfly populations. *J. Brit. Drag. Soc.* 6, 21-23.
- Moore, P.D. & Bellamy, D.J. (1974) *Peatlands*. Elek Scientific Books Ltd., London.

- Moore, P.D. (1975) Origin of blanket mires. *Nature* 256, 267-269.
- Moore, P.D. & Chapman, S.D. (1986) *Methods in Plant Ecology*. Blackwell, Oxford.
- Moser, H. & Rauert, W (2005) Isotopic tracers for obtaining hydrologic parameters. In: P.K. Aggarwal, J.R. Gat and K.F.O. Froehlich (eds), *Isotopes in the Water Cycle: Past, Present and Future of a Developing Science*, pp. 11-24.
- Murphy, P. W. (1962) Extraction methods for soil animals. I. Dynamic methods with particular reference to funnel processes, pp. 75- 114. *In* P. W. Murphy [ed.], *Progress in soil zoology*. Butterworths, London.
- Myklebust, M.C., Hipps, L.E. & Ryel, R.J. (2008) Comparison of eddy covariance, chamber, and gradient methods of measuring soil CO<sub>2</sub> efflux in an annual semi-arid grass, *Bromus tectorum*. *Agric. Forest Meteorol.* 148, 1894-1907.
- NAVFAC (2004) *Guidance for habitat restoration monitoring: framework for monitoring paln development and implementation*. NAVFAC Risk Assessment Workshop. UG-2061-ENV.
- Nay, S.M., Mattson, K.G. & Bormann, B.T. (1994) Biases of chamber methods for measuring soil CO<sub>2</sub> efflux demonstrated with a laboratory apparatus. *Ecology* 75, 24600-2463.
- NCC (1989) *Guidelines for the Selection of SSSIs*. NCC, Peterborough.
- NE (2005) *Higher Level Stewardship Handbook. Terms and Conditions and How to Apply*. Rural Development Services, Defra, London.
- NE (2008) *Higher Level Stewardship. Part C. Options, Capital Items and Management Conditions Handbook. Second Edition, October 2008*. Natural England, Peterborough.
- NE/MFF (2009) *Upland Restoration Manual*. Report by Natural England and Moors for the Future, in prep.
- Neal, C., House, W.A. & Down, K. (1998) An assessment of excess carbon dioxide partial pressures in natural waters based on pH and alkalinity measurements. *Sci. Tot. Environ.* 210/ 211, 173 –185.
- Nelson, D.W. & Sommers, L.E. (1982) Total carbon, organic carbon, and organic matter. In: R.H. Miller & D.R. Kenney (Eds.). *Methods of Soil Analysis: Chemical and Microbiological Properties*. ASA Monograph 9. American Society of Agronomy, Madison, Wisconsin, USA.
- Nelson, D.W. & Sommers, L.E. (1996) Total carbon, organic carbon, and organic matter. In: D.L. Sparks, A. Page, P. Helmke, R. Loeppert, P. Soltanpour, M. Tabatabai, C. Johnston, M. Sumner (eds.). *Methods of Soil Analysis: Chemical Methods*. 2<sup>nd</sup> Edition. Madison, WI: American Society of Agronomy. Pp. 961-1010.
- Nercessian, D., Upton, M., Lloyd, D. & Edwards, C. (1999) Phylogenetic analysis of peat bog methanogen populations. *FEMS Microbiology Letters* 173, 425-429.
- Neumann, H.H., den Hartog, G., Kling, K. & Chipanshi, A.C. (1994) Carbon dioxide fluxes over a raised open bog at Kinosheo Lake tower site during the Northern Wetlands Study (NOWES). *J Geophys Res.* 99, 1529 –1541.
- Niedermeier, A. & Robinson, J.S. (2007) Hydrological controls on soil redox dynamics in a peat-based, restored wetland. *Geoderma* 137, 318-326.



- Nisbet, T. (2005) Water use by trees. Forestry Commission Information Note 65. Forestry Commission, Edinburgh, pp. 1-8.
- Nollet, L.M.L. (2000) Handbook of water analysis. Marcel Dekker. Inc.
- O'Connor, F.B. (1962) The extraction of Enchytraeidae from soil. In: Murphy, P.W. (Ed.). Progress in Soil Zoology. Butterworths, London, pp. 279-285.
- Odum, H.T. (1971) Environment, Power, and Society. Wiley-Interscience New York, N.Y.
- Ogden, J.C., Davis, S.M. & Brandt, L.A. (2003) Science strategy for a regional ecosystem monitoring and assessment program: The Florida Everglades example. In: D.E. Busch & J.C. Trexler (Eds.). Monitoring Ecosystems: Interdisciplinary Approaches for Evaluating Ecoregional Initiatives. Island Press.
- Økland, R.H. (1986) Rescaling of ecological gradients III The effect of scale on symmetry of species response curves. Nord J Bot 6, 671–677.
- Økland R.H. (1990) Vegetation ecology: theory, methods and applications with reference to Fennoscandia. Sommerfeltia 1, Supplement.
- Oleszczuk, R. & Brandyk, T. (2008) The analysis of shrinkage-swelling behaviour of peat-moorsh soil aggregates during drying-wetting cycles. Agronomy Research 6, 131-140.
- Oostermeijer, J.G.B., Van' T Veer, R. & Den Nijs, J.C.M. (1994) Population structure of the rare, long-lived perennial *Gentiana pneumonanthe* in relation to vegetation and management in the Netherlands. J. Appl. Ecol. 31, 428-438.
- O'Reilly, C. (2008) Peatscapes project: *Sphagna* as management indicators research. Final report to North Pennines AONB Partnership.
- Orloci, L. (1978) Multivariate analysis in vegetation research. Second Edition. Dr. W. Junk Publishers. The Hague, Netherlands.
- Owen, M. (1971) The selection of feeding sites by White-fronted Geese in winter. J. App. Ecol. 8, 905-917.
- Oxford, G.S. & Scott, A.G. (2003) The spider fauna of Askham Bog, York, and the assessment of conservation value. Naturalist 128, 157–170
- PAA (2002) Raised Bog Restoration. A Review of Techniques used in Greater Manchester. Unpublished report to English Nature, Peterborough.
- PAA (2003) Vegetation Change in the English Uplands Following Removal of Management. Establishment of Baseline Data. English Nature Contract VT0321. Unpublished report to English Nature.
- PAA (2006) Monitoring Demonstration Moors in England and Wales. Final Report. Defra Contract BD1237. Unpublished report to Defra.
- PAA (2006) Waddington Fell Quarry, Vegetation Monitoring 2006. Unpublished report to Aggregate Industries UK Ltd.

Paul, E.A., Harris, D., Klug, M.J. & Ruess, R.W. (1998) The determination of microbial biomass. In G.P. Roberston, D.C. Coleman, C.S. Bledsoe & P. Sollins (Eds). *Standard Soil Methods for Long-Term Ecological Research*. LTER Oxford.

Perrow, M. R. & A. J. Davy (Eds.) (2002) *Handbook of Ecological Restoration. Volume 1: Principles of Restoration; Volume 2: Restoration in Practice*. Cambridge University Press, Cambridge, UK.

Phillips, J., Yalden, D. & Tallis, J. (1981) Peak District Moorland Erosion Study. Phase 1 Report. Peak Park Joint Planning Board, Bakewell.

Pielou, E.C. (1984) *The interpretation of ecological data: a primer of classification and ordination*, p. 263. John Wiley & Sons, New York, Chichester, Brisbane, Toronto, Singapore.

Pollard, E. (1979) A national scheme for monitoring the abundance of butterflies: the first three years. *British Entomological and Natural History Society, Proceedings and Transactions* 12, 77-90.

Pond Action (1989) *National Pond Survey. Methods Booklet*. Pond Action, Oxford Polytechnic, Oxford.

Poulin, M., Careau, D., Rochefort, L., Desrochers, A. (2002) From satellite imagery to peatland vegetation diversity: how reliable are habitat maps? *Conservation Ecology* 6, 16.

Proctor, M.C.F. (1992) Regional and local variation in the chemical composition of ombrogenous mire waters in Britain and Ireland. *Journal of Ecology* 80, 719-736.

Proctor, M.C.F. (1992) Regional and local variations in the chemical composition of ombrogenous mire water in Britain and Ireland. *Journal of Ecology* 80, 719-736.

Proctor, M.C.F. (2005) Temporal variation in the surface water chemistry of a blanket bog on Dartmoor, southwest England: analysis of 5 years' data. *European Journal of Soil Science* 57, 167-178.

Quinty, F. & Rochefort, L. (2003): *Peatland restoration guide, 2.*, Canadian Peat Moss Association and New Brunswick Department of Natural Resources and Energy, Quebec, Quebec, 106 pp.

Ratcliffe, D.A. (1977) *A Nature Conservation Review*, vol. 1. Cambridge University Press, Cambridge.

Reddy, K.R. & E.M. D'Angelo (1994) Soil processes regulating water quality in wetlands. p. 309–324. *In* W.J. Mitsch (ed.) *Global wetlands: Old world and new*. Elsevier, Amsterdam.

Reichman, R. & Rolston, D.E. (2002) Design and performance of a dynamic gas flux chamber. *J. Environ. Qual.* 31, 1774-1781.

Relys, V., Koponen, S., Dapkus, D. (2002) Annual differences and species turnover in peat bog spider communities. *Journal of Arachnology* 30, 416–424.

Richardson, J.L. and Vepraskas, M.J. (2001) *Wetland Soils: Genesis, Hydrology, Landscapes and Classification*. CRC.

Rizutti, A. M., Cohen, A. D. & Stack, E. M. (2004): Using hydraulic conductivity and micropetrography to assess water flow through peat-Containing Wetlands, *International Journal of Coal Geology*, No 60, p. 1-16.

Roberts, M.J. (1985) *The Spiders of Great Britain and Ireland*, vol. 1. Harley Books, Colchester.

Roberts, M.J. (1987) *The Spiders of Great Britain and Ireland*, vol. 2. Harley Books, Colchester.

- Roberts-Pichette, Patricia, and Lynn Gillespie (1999) Terrestrial vegetation biodiversity monitoring protocols. EMAN Occasional Paper Series, Report No. 9. Ecological Monitoring Coordinating Office, Burlington, Ontario.
- Robertson, G.P., Coleman, D.C., Bledsoe, C.S. & Sollins, P. (1998a) Standard Soil Methods for Long-Term Ecological Research. LTER. Oxford.
- Robertson, G.P., Sollins, P., Ellis, B.G. & Lajtha, K. (1998) Exchangeable ions, pH, and cation exchange capacity. In G.P. Robertson, D.C. Coleman, C.S. Bledsoe, & P. Sollins, (Eds.). Standard Soil Methods for Long-Term Ecological Research. LTER. Oxford.
- Robertson, G.P. & Paul, E.A. (2000) Decomposition and Soil Organic Matter Dynamics. In: O.E. Sala, R.B. Jackson, H.A. Mooney & R.W. Howarth (2000) Methods in Ecosystem Science. Springer.
- Rodwell, J.S. (1991) British Plant Communities Volume 2. Mires and Heaths. CUP, Cambridge.
- Ronkanen, A.K. & Kløve, B. (2007). Use of stable isotopes and tracers to detect preferential flow patterns in a peatland treating municipal wastewater. Journal of Hydrology. Volume 347, Issues 3-4, 30 December 2007, Pages 418-429
- Ross, J.P. (1981) The radiation regime and architecture of plant stands. The Hague, Netherlands.
- Ross, S. & Cowan, R. (2003) Review of the success of raised bog restoration techniques used in Greater Manchester. In: (R. Meade) Proceedings of the Risley Bog Restoration Monitoring Workshop, 26-27 February 2003. English Nature, Peterborough.
- Ross, S.Y. (1999) Relationships between Hydrology, Hydrochemistry and Vegetation Patterning on Scottish Fens. Unpublished PhD Thesis, University of Stirling.
- Ross, S.Y., Adamson, H.A. & Moon, A. (2003) Evaluating management techniques for controlling *Molinia caerulea* and enhancing *Calluna vulgaris* on upland wet heath in Northern England, UK. Agriculture, Ecosystems and Environment 97, 39-49.
- Sala, O.E., Jackson, R.B., Mooney, H.A. & Howarth, R.W. (2000) Methods in Ecosystem Science. Springer.
- Sanjit, L. & Bhatt, D. (2007) How relevant are the concepts of species diversity and species richness? J. Biosciences 30, 557-560.
- Savage, K.E. & Davidson, E.A. (2003) A comparison of manual and automated systems for soil CO<sub>2</sub> flux measurements: trade-offs between spatial and temporal resolution. J. Exp. Bot. 54, 891-899.
- Schaller, N. (1993) Sustainable agriculture and the environment: the concept of agricultural sustainability. Agriculture, Ecosystems and Environment 46, 89-97.
- Scheffer, M. (1998) Ecology of shallow lakes. Population and community biology. Series 22. Chapman & Hall, London.
- Schimel, D.S., VEMAP Participants, Braswell, B.H. (1997) Continental scale variability in ecosystem processes: Models, data and the role of disturbance. Ecological Monographs 67, 251-271.
- Schneegurt, M.A., Dore, S.Y., Kulpa, C.F. Jr. (2003) Direct extraction of DNA from soils for studies of microbial ecology. Curr. Issues Mol. Biol. 5, 1-8.

- Schumann, M. & Joosten, H. (2008) Global Peatland Restoration Manual. Institute of Botany and Landscape Ecology, Griefswald University, Germany. <http://www.imcg.net/docum/prm/prm.htm>
- Scott, A.G., Oxford, G.S. & Selden, P.A. (2006) Epigeic spiders as ecological indicators of conservation value for peat bogs. *Biol. Conserv.* 127, 420-428.
- Scudder, G.G.E. (1996) Terrestrial and freshwater invertebrates of British Columbia: Priorities for inventory and descriptive research. Res. Br., B.C. Min. For., and Wildl. Br., B.C. Min. Environ., Lands and Parks. Victoria, B.C. Work. Pap. 09/1996.
- SER (Society for Ecological Restoration International Science & Policy Working Group (2004) The SER International Primer on Ecological Restoration.
- Shaw (2001): Hydrology in Practice. Chapman and Hall, London. ISBN 0-412-37540-0.
- Shaw, S.C. and Wheeler, B.D. 1991. A review of the habitat conditions and management characteristics of herbaceous fen vegetation types in lowland Britain. Additional site accounts for sites transitional between rich and poor fen. Unpublished report, University of Sheffield.
- Shuman, C.S. & Ambrose, R.F. (2003) A comparison of remote sensing and ground-based methods for monitoring wetland restoration success. *Restoration Ecology* 11, 325-333.
- Shurpali, N.J., Verma, S.B., Kim, J. & Arkebauer, T.J. (1993) Seasonal distribution of methane flux in a Minnesota peatland measured by eddy correlation. *J Geophys Res* 98, 20649 – 20655.
- Silvan, N., Laiho, R. & Vasander, H. (2000) Changes in mesofauna abundance in peat soils drained for forestry. *For. Ecol. Mang.* 133, 127-133.
- Simpson, E. H. (1949) Measurement of diversity. *Nature* 163, 688
- Simpson, G. G. (1964) Species densities of North American recent mammals. *Syst. Zoo.* 13, 57-73.
- Sinsabaugh, R.L., Klug, M.J., Collins, H.P., Yeager, P.E. & Petersen, S.O. (1998) Characterizing soil microbial communities. In: G.P. Robertson, D.C. Coleman, C.S. Bledsoe & P. Sollins (Eds). *Standard Soil Methods for Long-Term Ecological Research*. LTER Oxford.
- Slaymaker, H.O. (1872) Patterns of present sub-aerial erosion and landforms in mid-Wales. *Transactions, Institute of British Geographers* 55, 47-68.
- Smale, M. C., Whaley, P. T. & Smale, P. N. (2001) Ecological restoration of native forest at Aratiatia, north Island, New Zealand. *Restoration Ecology* 9, 28-37.
- Smirnov, N.N. (1961) Food cycles in sphagnum bogs. *Hydrobiologia* 17, 175-182.
- Smith, P., Chapman, S.J. Scott, W.A., Black, H.J., Wattenbach, M., Milne, R., Campbell, C.D., Lilly, A., Ostle, N., Levys, P.E., Lumsdon, D.G., Millard, P., Towers, W., Zaehle, S. & Smith, J.U. (2007) Climate change cannot be entirely responsible for soil carbon loss observed in England and Wales, 1978-2003. *Global Climate Change* 13, 2605-2609.
- Snyder, J.D. & Trofymow, J.A. (1984) A rapid accurate wet oxidation diffusion procedure for determining organic and inorganic carbon in plant and soil samples. *Communications in Soil Science and Plant Analysis* 15, 587-597.

- Sollins, P., Glassman, C., Paul, E.A., Swanston, C., Lajtha, K., Heil, J.W. & Elliot, E.T. (1998) Soil Carbon and Nitrogen: Pools and Fractions. In: G.P. Roberston, D.C. Coleman, C.S. Bledsoe & P. Sollins (Eds). Standard Soil Methods for Long-Term Ecological Research. LTER Oxford.
- Sorheim, R., Torsvik, V.L. & Goksoyr, J. (1989) Phenotypic divergences between populations of soil bacteria isolated on different media. *Micro. Ecol.* 17, 181-192.
- Standen, V. (1978) The influence of soil fauna on decomposition by microorganisms in blanket bog litter. *J. Anim. Ecol.* 47, 25±39.
- Standen, V. & Latter, P.M. (1977) Distribution of a population of *Cognettia sphagnetorum* (Enchytraeidae) in relation to microhabitats in a blanket bog. *J. Anim. Ecol.* 46, 213±229.
- Stevenson, F.J. (1986) Cycles of soil. Carbon, nitrogen, phosphorus, sulphur and micronutrients. Wiley, New York.
- Stoneman, R. & Brooks, S. (1997): *Conserving Bogs - The Management Handbook*, The Stationery Office, Edinburgh, 286 pp.
- Stott, T. (2005) Natural recovery from accelerated forest ditch and stream bank erosion five years after harvesting of plantation forest on Plynlimon, mid-Wales. *Earth Surface Processes and Landforms* 30, 349-357.
- Sutherland, W.J. (1996) *Ecological Census Techniques: A handbook*. Cambridge University Press.
- Sutherland, W.J. (2000) *The conservation handbook: research management and policy*. Blackwell Publishing. Oxford.
- Taffs, K.H., Parr, J.F. & Bolton, K. (2006) Using Palaeobotanical techniques to guide peatland restoration. A case study from Byron Bay, Australia. *Ecological Management and Restoration*, 7(2): 132- 135.
- Tallis, J.H. & Yalden, D.W. (1983) Peak District Moorland Restoration Project. Phase 2 Report: Re-vegetation Trials. Peak Park Joint Planning Board, Bakewell.
- Thomas, J.A. (1983) A quick method for estimating butterfly numbers during surveys. *Biol. Conserv.* 27, 195-211.
- Thomson, A. (2004) *Match Version 4 Beta*. University of Lancaster, Lancaster.
- Tiner, R. W. (1991) The concept of a hydrophyte for a wetland identification. *BioScience* 41, 236-247.
- Tiner, R.W. (1999) *Wetland Indicators: A Guide to Wetland Identification, Delineation, Classification, and Mapping*. Lewis Publishers. CRC Press Inc., Corporate Boulevard NW, Boca Raton.
- Todd, P.A., Phillips, J.D.P., Putwain, P.D. & Marrs, R.H. (2000) Control of *Molinia caerulea* on moorland. *Grass & Forage Science* 55, 181-191.
- Tomàs Vives, P. (1996) *Monitoring Mediterranean Wetlands: A Methodological Guide*. MedWet Publication; Wetlands International, Slimbridge, UK and ICN, Lisbon.
- Trepel, M., Dall'O, M., Cin, L. D., Wit, M., Opitz, S., Palmeri, L., Perrson, J., Pieterse, N. M., Timmermann, T., Bendoriccio, G., Kluge, W. & Jorgensen, S. E. (2000): Models for wetland planning, design and management, *EcoSys*, No 8, p. 93-137.

- Tretzel, E. (1955) Intragenerische Isolation und Interspezifische Konkurrenz bei Spinnen. *Zeitschrift fuer Morphologie und Oekologie der Tiere* 44, 43–162.
- Treweek, J., Jose, P. and Benstead, P. ed. (1997): *The wet grassland guide – Managing floodplain and coastal wet grasslands for wildlife*, The Royal Society for the Protection of Birds, 254 pp.
- Turetsky, M.R., Manning, S.W. & Wieder, R.K. (2004) Dating recent peat deposits. *Wetlands* 24, 324–56.
- UNFCCC. Report of the conference of the parties on the second part of the sixth session, held at Bonn, 16th–17<sup>th</sup> July 2001, FCCC/CP/2001/5, United Nations, Geneva.
- Usher, M.B. (1991) Scientific requirements of a monitoring programme. Pages 15- 32 *in* B. Goldsmith, (Ed.) *Monitoring for conservation and ecology*. Chapman & Hall, London.
- van der Valk, A.G. (1998) Succession theory and restoration of wetland vegetation. In (A.J. McComb & J.A. Davis) *Wetlands for the Future. Contributions from INTECOL'S V International Wetlands Conference*. Gleneagles Publishing, Adelaide.
- Van der Schaaf, S. (1999): *Analysis of the hydrology of raised bogs in the irish midlands. A case study of Raahenmore Bog and Clara Bog*, Ph.D.-Thesis, University of Wageningen.
- van Dijk, J., Didden, W.A.M., Kuenen, F., van Bodegom, P.M., Verhoef, H.A. & Aerts, R. (*in press*) Can differences in soil community composition after peat meadow restoration lead to different decomposition and mineralisation rates? *Soil Biol. Biochem.*
- Van Duinen, G., Brock, A., Kuper, J., Peeters, T. & Esselink, H. (2004) Do raised bog restoration measures rehabilitate aquatic fauna diversity? A comparative study between pristine, degraded, and rewetted raised bogs. In: Paivanen, J. (Ed.). *Wise use of peatlands. Proceedings of the 12<sup>th</sup> International Peat Congree. 6-11 June 2004 Tampere, Finland* P.. 399-405.
- van Vliet, P.C.J., Beare, M.H. & Coleman, D.C. (1995) Population dynamics and functional roles of enchytraeidae (Oligochaeta) in hardwood forest and agricultural ecosystems. *Plants and Soil* 170, 199-207.
- Vilkamaa, P. (1981) Soil fauna in a virgin and two drained dwarf shrub pine bogs, *Suo* 32: 20±122 (in Finnish with English summary).
- Vitt, D.H. & Pakarinen, P. (1977) The bryophyte vegetation, production, and organic components of Truelove Lowland. In L.C. Bliss (ed.). *Truelove Lowland, Devon Island, Canada: A High Arctic Ecosystem*. University of Alberta Press, Edmonton, pp. 225-244
- Vitt, D.H. (2007) Estimating moss and lichen ground layer net primary production in tundra, peatlands, and forests. In T.J. Fahey & A.K. Knapp. (eds.). *Principles and standards for measuring primary production*. Oxford University Press.
- Vittoz, P. & Guisan, A. (2007) How reliable is the monitoring of permanent vegetation plots? A test with multiple observers. *J. Vegetation Science* 18, 413-422
- Vives, P.T. (1996) *Monitoring Mediterranean Wetlands: A Methodological Guide*. Wetlands International.

- Von Post, L. & Granlund, E. (1926) SODRA Sveriges tortillgångar. Sveriges. Geologiska Undersökning , ser. C. 335.
- Waddington, J.M. & Roulet, N.T. (1996) Atmosphere-wetland carbon exchanges: scale dependency of CO<sub>2</sub> and CH<sub>4</sub> exchange on development topography of a peatland. *Global Biogeochem Cycles* 10, 233–245.
- Wagner W., Verhoest N. E. C., Ludwig R., and Tedesco M. (2009) Remote sensing in hydrological sciences. *Hydrol. Earth Syst. Sci.*, 13, 813–817, 2009
- Walker, J, Holden, J., Evans, M., Worrall, F., Davison, S., and Bonn, A. (2008) A compendium of UK peat restoration and management projects. Report to Defra, project code SP0556. [http://randd.defra.gov.uk/Document.aspx?Document=SP0556\\_7584\\_FRP.pdf](http://randd.defra.gov.uk/Document.aspx?Document=SP0556_7584_FRP.pdf)
- Wallage, Z.E., Jones, T. & Holden, J. (2006) Determining the effect of peatland drainage and restoration on the rate of microbial activity in an upland blanket peat. *Geophys. Res. Abs.* 8, 02691
- Warburton, J., Holden, J. & Mills, A.J. (2004) Hydrological controls of surficial mass movements in peat. *Earth-Science Reviews* 67, 139-156.
- Wardenaar, E. (1987) A new hand tool for cutting peat. *Can. J. Bot.* 65, 1772–1773.
- Wasilewska, L. (1991) Long-term changes in communities of soil nematodes on fen peat meadows due to the time since their drainage. *Ekol. Pol.* 39, 59-104.
- Wasilewska, L. (2006) Changes in the structure of the soil nematode community. *App. Soil. Ecol.* 32, 165-179.
- Weisse, T., Muller, H., Pinto-Coelho, R.M., Schweizer, A., Springmann, D. & Baldringer, G. (1990) Response of the microbial loop to the phytoplankton spring bloom in a large pre-alpine lake. *Limnology and Oceanography* 35, 781–794.
- Welles, J.M., Demetriades-Shah, T.H. & McDermitt, D.K. (2001) Considerations for measuring ground CO<sub>2</sub> efflux with chambers. *Chemical Geology* 177, 3-13.
- Westman, W.E. (1991) Ecological restoration projects: measuring their performance. *Environmental Professional* 13, 207-215.
- Wheeler, B.D. & Shaw, S.C. (1995) Restoration of damaged peatlands. HMSO, London.
- Wheeler, B D & Shaw, S C. (2000). *A Wetland Framework For Impact Assessment At Statutory Sites In Eastern England*. Environment Agency R&D Note. W6-068/TR1 and TR2.
- Wheeler, B.D. & Proctor, M.C.F. (2000) Ecological gradients, subdivisions and terminology of north-west European mires. *Journal of Ecology* 88, 187-203.
- Wheeler, B.D., Gowing, D.J.G., Shaw, S.C., Mountford, J.O. & Money, R.P. (2004) Protecting and Enhancing Wetlands. *Ecohydrological Guidelines for Lowland Wetland Plant Communities*. Final Report December 2004. Environment Agency, Peterborough.
- White, D.C. (1986) Validation of quantitative analysis of microbial biomass, community structure, and metabolic activity. *Ergebnisse der Limnologie* 31, 1-18.

- Whiting, G.J. (1994) CO<sub>2</sub> exchange in the Hudson Bay Lowlands: community characteristics and multispectral reflectance properties. *J Geophys Res* 99, 1519–1528.
- Wielgolaski, F.E. (1972) Production, energy flow and nutrient cycling through a terrestrial ecosystem at a high altitude area in Norway. Pp. 283-290 in F.E. Wielgolaski & T.H. Rosswall (eds.), *Proceedings of the IVth International Meeting on the Biological Productivity of Tundra*. Tundra Biome Steering Committee, Stockholm, Sweden
- Wielgolaski, F.E. (1975) Primary productivity of alpine meadow communities. In F.E. Wielgolaski (ed.). *Tundra Biome: Fennoscandian Tundra Ecosystems*, vol. 1, Plants and Microorganisms. Springer-Verlag, Berlin, pp. 121-128.
- Wijaya, K., Nishimura, T. & Kato, M. (2003) Estimation of dry bulk density of soils using amplitude domain reflectometry probe. *J. Jpn. Soc. Soil Phys.* 95, 63-73.
- Williams, B.L. & Silcock, D.J. (2000) Impact of NH<sub>4</sub>NO<sub>3</sub> on microbial biomass C and N and extractable DOM in raised bog peat beneath *Sphagnum capillifolium* and *S. recurvum*. *Biogeochemistry* 49, 259-276.
- Wilson, K., Goldstein, A., Falge, E., Aubinet, M., Baldocchi, D., Berbigier, P., Bernhofer, C., Ceulemans, R., et al. (2002) Energy balance closure at FLUXNET sites. *Agric. For. Meteorol.* 113, 223–243.
- Winward, A.H. & Martinez, G.C. (1983) Nested frequency – an approach to monitoring trend in rangeland and understory timber vegetation. In J.F. Bell & T. Atterbury (eds.). *Proceedings of International Conference on Renewable Resource Inventories for Monitoring Changes and Trends (15-19 August, 1983)*. Oregon State University pp. 737.
- Worrall, F. Burt, T.P., Jaeban, R.Y., Warburton, J. and Shedden, R. (2002). Release of dissolved organic carbon from upland peat. *Hydrological Processes*, 16, 3487-3504.
- Worrall, F., Reed, M., Warburton, J. & Burt, T. (2003) Carbon budget for a British upland peat catchment. *Sci. Tot. Env.* 312, 133-146.
- Worrall, F., Burt, T.P., Rowson, J.G. Warburton, J. & Adamson, J.K. (2009) The multi-annual carbon budget of a peat-covered catchment. *Sci. Tot. Env.*
- Worrall, F. and Evans, M.G. (2009) The carbon budget of upland peat soils. In: Bonn, A., Allott, T., Hubacek, K. and Stewart, J (eds.) *Drivers of environmental change in uplands*, pp. 93-113. Routledge, London and New York
- Ying-Bing, T., Ming-Biao, X. & Guang-Yu, S. (2004) Study on Change of Soil Organic Matter in the Process of Wetland Ecological Restoration in Ruergai Plateau *Wetland Science*. 2, 88-93.
- Zadorina, E.V., Slobodova, N.V., Boulygina, E.S., Kolganova, T.V., Kravchenko, I.K. & Kuznetsov, B.B. (2009) Analysis of the diversity of diazotrophic bacteria in peat soil by cloning of the *nifH* gene. *Microbiology* 78, 218-226.
- Zedler, J.B. & Callaway, J.C. (2002) Tracking wetland restoration: do mitigation sites follow desired trajectories? *Restoration Ecology* 7, 69-73.



Zelles, L., Bai, Q.Y. & Beese, F. (1992) Signature fatty acids in phospholipids and lipopolysaccharides as indicators of microbial biomass and community structure in agricultural soils. *Soil Biol. Biochem.* 24, 317-323.

Zhou, J., Bruns, M.A. & Tiedje, J.M. (1996) DNA recovery from soils of diverse composition. *Appl. Environ. Microbiol.* 62, 316-322.

## APPENDIX 1: ONLINE SURVEY SUMMARY

An online survey was conducted at [www.surveymonkey.com](http://www.surveymonkey.com) to evaluate the extent of monitoring occurring within the Peat Compendium restoration projects in England and Wales. Of 130 projects contacted, 29 responded (22 %). Of the 29 that responded, 3 were removed due to incomplete answers.

### 1. Project name

1	SCaMP 2
2	Redgrave and Lopham Fen Restoration Project
3	Cayton and Flixton Carrs Wetland Project
4	Moors for the Future Fire site restoration
5	The HEATH Project
6	Dark Peak SSSI - restoration of favourable condition
7	Duddon Mosses National Nature Reserve
8	NWL Tees Water Colour Project
9	Fenn's, Whixall & Bettisfield Mosses NNR
10	Fylingdales Fire Site Revegetation Project
11	Peatscapes
12	LIFE Active Blanket Bog in Wales
13	Cuilcagh Mountain Blanket bog restoration
14	Back to Black, the restoration of May Moss
15	Wicken Fen Vision
16	Several projects: Cockayne Head/High Blowworth, Glaisdale Moor, Arden Great Moor, Fylingdales Moor
17	Fen restoration, Bure Marshes NNR
18	Simon Stainer, Natural England
19	RSPB Geltsdale Nature Reserve
20	Brue Valley peatland restoration
21	The Exmoor Mire Restoration Project
22	Mosslands Project
23	Dartmoor Blanket Bog Restoration Project
24	Western Isles peatlands management scheme
25	The Pumlumon Project
26	Isle of Axholme lowland raised bogs

## 2. Please provide information on how your project was planned

1	Second phase of the SCaMP initiative delivering 2010 - 2015 across the United Utilities (UU) plc Central & Northern estates. Our role is to draft farm management plans to deliver benefits to raw water quality by encouraging entry into agri-environment schemes, targeted land management including livestock management, soil and vegetation management & management for specific habitats and species, investment in farm facilities. Monitoring will be undertaken by UU staff once delivery of the farm plans is underway in 2010.
2	Papers written identifying restoration needs; EU Life grant application; formation of project steering committee with all relevant organisations; public talks and meetings.
3	Partnership of agencies set up a steering group including stakeholders (farmers, IDB etc). EA funded feasibility work on wet grassland restoration. On the ground restoration work planned piecemeal via HLS agreements between Project Officer and landowners
4	The initial projects were planned and funded through a HLF grant, based on areas of greatest need across the Peak District moorland.
6	Assessment of condition status of SSSI. Forecast remedy for units and costs. Plan selected works. Bid for money.
7	Ongoing restoration works since early 1990's. Largely driven by funding available each year. Work defined in NNR management plan.
8	It was planned as part of our capital programme for AMP5 to address water quality (DOC) issues affecting our Broken Scar WTW, and thus approved by Ofwat.
9	Advice from NE national monitoring staff plus as opportunities arise.
10	Partnership approach - led by North York Moors National Park Authority. Involved landowner, Court Leet, English Heritage, Natural England and Rural Development Service
12	LIFE bid by RSPB, CCW, FCW, EA
13	Through an in-depth research phase combined with experience of professional environmental consultants.
14	Restoration of conifer forest to blanket mire was originally gathered for a life bid in 2001. The bid failed however funding has been awarded from SITA Trust. The work was agreed with a range of internal and external partners and long term monitoring has been built into the restoration process.
15	Planned to secure the long term future of species living on the Wicken Fen NNR. Intention is to re-wet the peatland area creating a mosaic of habitats.
16	N/A - several projects
17	Initial planning from Broads Fen Resource survey (1994) - identified areas to be cleared of scrub and post 1946 woodland with good chance of achieving successful restoration to S24 fen communities. Project specification written after ground-truthing of survey findings on Woodbastwick Marshes; spec. stated desired end-points rather than methods. Assessment of tenders on method viability, as well as price.

<b>18</b>	Planned through national SSSI PSA target
<b>19</b>	5 year management plan cycle Liaison with NE/ North Pennines AONB Peatscapes
<b>21</b>	<p>The project began as a pilot to test the methods and monitor the results on a small area of moorland in 1998. The pilot established that it was possible to use the ditch blocking techniques successfully used elsewhere in the UK on Exmoor peatlands and that the ecological and hydrological effects of this ditch blocking were measurable. The success of this initial work led to the establishment of the current landscape scale partnership project in 2006.</p> <p>The pilot project was initiated by a partnership of the National Park Authority, English Nature (Natural England), The Environment Agency and other organisations interested in the management of Exmoor's moorlands and rivers such as the Exmoor Society and the West Country Rivers Trust. Without this broad consensus for action it is unlikely that the pilot project would have been successful in gaining support for a larger follow on project.</p>
<b>22</b>	A group of organisations came together in 2005 to find solutions to a variety of problems facing the mosslands project area. The group is called the Mosslands Action Group and they steer and oversee work that aims to find a sustainable way forward for the area.
<b>23</b>	Planned as a pilot project by the Action for Wildlife Partnership. This project is specifically aimed at blanket bog, beginning with pilot work to investigate the most suitable techniques, their effectiveness, cost and a range of related practical issues.
<b>24</b>	Post designation of SAC, project was seen as a viable means through which to deliver favourable condition of habitats concerned.
<b>25</b>	Drafted business plan followed by targeted funding bids.
<b>26</b>	Water level management plan with the Internal Drainage Board to raise water levels. Site management by Lincolnshire Wildlife Trust.

### 3. Please specify the vegetation types on each site (summary)

Answer Options	Phase 1 habitat	Response Frequency	Response Count
Blanket bog	E1.6.1	57.7%	15
Upland heathland	D	50.0%	13
Fen, marsh & swamp	E3,F	34.6%	9
Open water	G	34.6%	9
Other		34.6%	9
Bog	E	19.2%	5
Lowland raised bog	E1.6.2	19.2%	5
Reedbed		15.4%	4
Lowland heathland	D	11.5%	3

### 3a. Other vegetation types

Project	Other (please specify)
1	Improved grassland, upland hay meadow, clough woodland
2	Wet woodland
3	Drained pasture/arable farmland on deep peat
9	U1c grassland, semi-improved pasture
17	Wet woodland
19	Upland farmland/upland woodland
21	Upland valley mires
23	Other vegetation types are present but only blanket bog is the focus of this project
25	Improved grassland, woodland and ffridd (a complex mosaic of heath, bracken, woodland, acid grassland, old workings and wet flushes).

### 3b. Vegetation types on each site (in detail)

	Blanket bog	Upland heathland	Bog	Lowland heathland	Lowland raised bog	Fen, marsh & swamp	Reedbed	Open water
1	x	x	x					x
2				x		x	x	x
3								
4	x	x						
5				x				
6	x	x						
7				x	x			x
8	x							
9					x	x		
10		x						
11	x	x	x					
12	x							
13	x	x						
14	x	x						
15						x	x	x
16	x	x						
17						x	x	x
18	x	x						
19	x	x						
20					x	x	x	x
21	x	x	x			x		
22					x	x		x
23	x							
24	x	x	x			x		x
25	x	x	x			x		x
26					x			

**4a. Please specify which parameters were deemed important for instigating the project**

<b>Answer Options</b>	<b>Response Frequency</b>	<b>Response Count</b>
Biodiversity	92.3%	24
Conservation status e.g. PSA, BAP, HLS	88.5%	23
Vegetation cover/composition	73.1%	19
Water table depth	50.0%	13
Carbon storage/sequestration	42.3%	11
Water quality	38.5%	10
Flood risk management	38.5%	10
Cultural heritage	34.6%	9
Water supply	26.9%	7
Other	26.9%	7
Paleoenvironmental evidence	19.2%	5
Greenhouse gas emissions	15.4%	4

**4b. Other parameters**

	<b>Other</b>
<b>1</b>	Agri-economics
<b>3</b>	Eco-tourism, access and interpretation
<b>4</b>	Landscape significance
<b>5</b>	Archaeological landscape
<b>11</b>	Sediment, economy
<b>20</b>	NNR visitors
<b>22</b>	Agriculture (decline of), recreation potential, hydrology

## 5. Please outline your main goals/objectives of restoration

1	Restore bare peat through rewetting and revegetating with reduced grazing to reduce erosion, improve water colour, secure carbon and encourage sequestration. Plant upland oak woodland to stabilize soils, create habitat, reduce risk to water quality. Manage vegetation to reduce fire risk on upland habitats. Manage livestock and vegetation for specific habitats and species eg lapwing, curlew, twite, Sphagnum, heather, hay meadow forbs.
2	Relocate water abstraction public borehole; restore river corridor habitat; restore fen habitat and rejuvenate damaged areas with peat scraping works and major scrub removal programme; reintroduce large-scale extensive grazing over whole site; build visitor centre and car park; create nature trails.
3	Local and National BAP habitats: restore/ create mosaic of wetland habitats, predominantly wet grassland on drained farmland. Support and increase breeding populations of wetland and farmland bird species. Archaeology: protect waterlogged palaeoenvironmental deposits associated with a unique Mesolithic landscape. Find a more sustainable and economically viable way of farming on flood-prone land.
4	There are several projects within the Moors for the Future project based on restoring historic fire sites (reducing areas of bare peat through re-vegetation, reducing landscape significance of bare and eroding peat, assisting biodiversity, altering the condition status of the Dark Peak SSSI from unfavourable declining to unfavourable recovering).
5	Re-introduce active management to 3500 ha of lowland heath in west Cornwall.
6	Restore vegetation, limit erosion, raise water table.
7	To return as much of the historical mire extent to actively functioning/growing raised mire, by slowing down the rate of water loss to system through blocking of drains and cuttings.
8	The restoration involved blocking moorland grips with the aim of improving water quality (DOC) from the area).
9	Restore actively forming raised bog macrotope, carryout holding management if not yet possible
10	Re-vegetate the site as quickly as possible to prevent further erosion and protect archaeology.
11	Restoration Research Best Practice Celebration of peatlands
12	Bring about a significant and sustained improvement in the quality of blanket bog in the two project SACs.
13	Restore to active blanket bog and manage runoff in drainage basin associated with the Marble arch Caves.
14	Removal of poor quality conifer crop. Secure long term survival of the deep peat. Slow down water loss from site.
15	Creation of a landscape scale nature reserve to secure the long term future of species and habitat of Wicken Fen NNR.
16	Complete vegetation cover and restore water table.
17	Establishment of area of good-quality S24 fen (as "instant fen" after removal of woody species) without damage to fen surface. Part of overall strategy of succession management in Broads, aiming to increase area of open fen at expense of scrub/recent woodland.
18	SSSI restoration
19	Long-term restoration of active blanket bog in good condition, 5year target increasing good condition form 30% to 50% (by 2013)
20	Restoration of old peat workings and the protection of SPA and SSSI. Delivery of BAP targets

<b>21</b>	Exmoor supports ecologically important upland wetlands (blanket bogs and valley mires). These hydrologically sensitive ecosystems have been impacted by drainage, peat cutting and past land-management practices. The Exmoor Mire Restoration project aims to restore degraded Exmoor peatlands on a landscape scale and to promote the regeneration of moorland bog vegetation. The benefits of the work are: <ul style="list-style-type: none"> <li>• restoration of upland habitats and species,</li> <li>• carbon storage for climate change mitigation,</li> <li>• the re-establishment of natural stream-flows in Exmoor headwaters with improved aquatic environments and ecology,</li> <li>• sustainable moorland resource management</li> </ul>
<b>22</b>	The project area covers a variety of landuses/vegetation although it does not coordinate directly with restoration works itself - partner organisations on the mossland action group (such as Lancashire Wildlife Trust) do.
<b>23</b>	<ul style="list-style-type: none"> <li>• enhance condition of the blanket bog community</li> <li>• reduce run-off rates in high rainfall periods</li> <li>• retain flows in low rainfall periods</li> <li>• enhance breeding habitat suitability for wading birds</li> <li>• enhance the capacity of the bog to store carbon</li> </ul>
<b>24</b>	Bring SAC towards or into fav condition
<b>25</b>	To support a robust rich natural environment by maintaining local communities. These communities will deliver economically sustainable environmental services including flood water management, carbon management and environmental conservation.
<b>26</b>	To restore conditions suitable for lowland raised bogs. The target is to raise ground water levels to within 15cm of ground surface all year.

**6a. How important area the following issues in causing the need for restoration?**

<b>Answer Options</b>	<b>Response Frequency</b>	<b>Response Count</b>
Drainage	73.1%	19
Wildfire	42.3%	11
Overgrazing	38.5%	10
Vegetation succession	38.5%	10
Agricultural improvement	38.5%	10
Managed burning	30.8%	8
Peat extraction	26.9%	7
Afforestation	26.9%	7
Other	26.9%	7
Water pollution	23.1%	6
Recreation	19.2%	5
Air pollution	15.4%	4
Planning developments	7.7%	2



## 6b. Others

1	Livestock type, under grazing
4	Natural drainage systems - gullying
5	Abandonment of grazing and active management
6	Tick does not indicate scale!
9	Climate change
22	Fragmentation of landuse, increase in equine interests
23	Military activity

## 7a. Which of these restoration techniques are you performing on your site?

Answer Options	Response Frequency	Response Count
Rewetting	61.5%	16
Grip blocking	61.5%	16
Revegetation - reseeded	42.3%	11
Gully blocking	38.5%	10
Stock reduction/exclosure	38.5%	10
Stabilisation	30.8%	8
Vegetation removal	30.8%	8
Other	30.8%	8
Peat reprofiling	26.9%	7
Revegetation - planting	19.2%	5
Buffer zone	15.4%	4
Adjacent landuse change	15.4%	4
Draining	3.8%	1
Sediment removal	0.0%	0

## 7b. Others

3	Water Level Management - eg sluices, bunds, scrapes
5	Re-introduction of grazing, cutting and managed burning
7	Blocking wide peat cuttings
9	Visitor and media involvement
17	Management now maintenance only.
22	As project is not directly involved in individual site works, cannot reliably comment
24	Managed land use - grazing levels, muirburn etc
26	Re-wetting is proposed.

### 8. How important do you consider these parameters for monitoring restoration success?

Answer Options	N/A	Low	Medium	High	Rating Average	Response Count
Hydrology - function	1	2	2	21	2.76	26
Biodiversity	0	0	4	20	2.83	24
Plant community structure	0	0	8	17	2.68	25
Vegetation cover	0	2	3	17	2.68	22
Plant species indicators	0	1	9	16	2.58	26
Hydrology - quality	1	6	3	15	2.38	25
Breeding birds	1	2	10	11	2.39	24
Carbon storage	2	4	7	10	2.29	23
Peat integrity	1	3	7	10	2.35	21
Photography	3	2	11	6	2.21	22
Invertebrates	1	5	11	5	2.00	22
Greenhouse gas emissions	3	6	9	5	1.95	23
Remote sensing	5	5	8	3	1.88	21
Physicochemistry	3	7	7	3	1.76	20
Microbiology	4	9	7	0	1.44	20
Other	1	0	0	1	3.00	2

### 9. Which parameters have been measured pre- and post-restoration?

Answer Options	Pre	Post	Response Count
Plant species indicators	17	15	19
Vegetation cover	15	16	17
Plant community structure	15	15	18
Hydrology - function	13	12	15
Biodiversity	12	13	14
Photography	12	13	14
Breeding birds	12	12	15
Hydrology - quality	8	8	12
Remote sensing	8	5	9
Invertebrates	7	7	9
Physicochemistry	4	3	5
Peat integrity	4	3	5
Carbon storage	1	3	3
Greenhouse gas emissions	1	3	3
Other	1	2	3
Microbiology	0	2	2

**10a. How frequently do you measure each parameter?**

<b>Answer Options</b>	<b>Weekly</b>	<b>Monthly</b>	<b>Annually</b>	<b>Response Count</b>
Plant community structure	0	0	11	11
Plant species indicators	0	1	10	11
Vegetation cover	0	0	9	9
Biodiversity	0	1	8	9
Photography	0	0	9	9
Breeding birds	0	1	7	8
Invertebrates	1	0	5	6
Hydrology - quality	3	3	2	8
Hydrology - function	4	7	1	12
Physicochemistry	0	1	1	2
Microbiology	0	1	1	2
Carbon storage	0	1	1	2
Greenhouse gas emissions	0	2	0	2
Other	0	0	1	1
Peat integrity	0	0	0	0
Remote sensing	0	0	0	0

**10b. Others**

<b>2</b>	Air quality (monthly)
<b>4</b>	Many samples (physicochemistry, erosion rates) are measured every three months; remote-sensing and aerial photography have been every three years
<b>8</b>	Botanical aspects surveyed pre-blocking and will be re-surveyed 3 years later.
<b>9</b>	Water quality, biodiversity vegetation cover, structure and photography are on a 5 year basis unless yearly after forest clearance
<b>21</b>	Breeding bird surveys are at 5-10 year intervals
<b>26</b>	Water levels monitored bi monthly

**11. Do you have permanent or random plots for each parameter listed?** Plots are defined as specific large areas in which repeated measurements are taken. Within each plot, replicate measurements are taken such as multiple, random quadrats or permanent chamber collars for GHGs.

Answer Options	Permanent	Random	Response Count
Hydrology - function	11	1	12
Plant community structure	10	4	14
Vegetation cover	9	2	11
Plant species indicators	9	2	11
Photography	7	1	8
Breeding birds	6	5	11
Hydrology - quality	6	2	8
Biodiversity	5	2	7
Invertebrates	4	2	6
Carbon storage	2	1	3
Greenhouse gas emissions	2	0	2
Physicochemistry	1	1	2
Microbiology	1	0	1
Peat integrity	0	1	1
Other	1	0	1
Remote sensing	0	0	0

**12. Please choose the number of plots, the area of the plots, and the number of replicates collected within each plot.**

Answer Options	No. of plots							Response Count
	1-5	6-10	11-15	16-20	21-25	26-30	>30	
Hydrology - function	4	1	1	0	0	0	2	8
Plant community structure	1	0	1	1	1	0	4	8
Breeding birds	1	2	1	0	2	0	2	8
Hydrology - quality	2	2	1	0	0	0	2	7
Vegetation cover	1	0	1	0	1	0	4	7
Plant species indicators	1	0	1	1	0	0	3	6
Photography	0	1	2	0	0	0	2	5
Biodiversity	1	0	0	0	1	0	1	3
Invertebrates	2	0	0	0	0	0	0	2
Physicochemistry	0	2	0	0	0	0	0	2
Microbiology	1	0	0	0	0	0	0	1
Peat integrity	1	0	0	0	0	0	0	1
Carbon storage	0	1	0	0	0	0	0	1
Greenhouse gas emissions	0	1	0	0	0	0	0	1
Remote sensing	0	0	0	0	0	0	1	1
Other	0	0	1	0	0	0	0	1

<b>m2</b>					
<b>Answer Options</b>	<b>&lt;1</b>	<b>1-10</b>	<b>11-100</b>	<b>101-1000</b>	<b>Response Count</b>
Plant community structure	0	3	1	3	7
Plant species indicators	0	3	1	2	6
Vegetation cover	0	3	2	1	6
Breeding birds	0	0	0	6	6
Photography	0	3	1	1	5
Hydrology - function	2	0	1	2	5
Hydrology - quality	1	0	0	3	4
Biodiversity	0	0	1	2	3
Physicochemistry	1	0	0	0	1
Carbon storage	0	1	0	0	1
Greenhouse gas emissions	1	0	0	0	1
Invertebrates	0	0	0	1	1
Other	0	1	0	0	1
Microbiology	1	0	0	0	1
Peat integrity	0	0	0	1	1
Remote sensing	0	0	0	0	0

<b>No. of replicates</b>								
<b>Answer Options</b>	<b>1-5</b>	<b>6-10</b>	<b>11-15</b>	<b>16-20</b>	<b>21-25</b>	<b>26-30</b>	<b>&gt;30</b>	<b>Response Count</b>
Hydrology - function	4	1	1	0	0	1	0	7
Plant community structure	4	0	0	1	0	0	1	6
Plant species indicators	4	0	0	1	0	0	1	6
Hydrology - quality	4	1	0	0	0	0	0	5
Vegetation cover	3	0	0	1	0	0	1	5
Photography	4	0	0	0	0	0	0	4
Breeding birds	2	1	0	0	0	0	0	3
Biodiversity	1	1	0	0	0	0	0	2
Physicochemistry	0	1	0	0	1	0	0	2
Invertebrates	2	0	0	0	0	0	0	2
Carbon storage	1	0	0	0	0	0	0	1
Greenhouse gas emissions	1	0	0	0	0	0	0	1
Microbiology	1	0	0	0	0	0	0	1
Peat integrity	1	0	0	0	0	0	0	1
Remote sensing	0	0	0	0	0	0	0	0
Other	0	0	0	0	0	0	0	0

**13. Have you considered control or reference plots for any of the parameters?**

<b>Answer Options</b>	<b>Yes</b>	<b>No</b>	<b>Response Count</b>
Hydrology - function	8	2	10
Hydrology - quality	7	2	9
Plant community structure	7	2	9
Plant species indicators	6	2	8
Vegetation cover	6	2	8
Breeding birds	5	2	7
Physicochemistry	4	3	7
Carbon storage	4	3	7
Biodiversity	4	2	6
Invertebrates	4	2	6
Greenhouse gas emissions	3	3	6
Photography	3	2	5
Remote sensing	2	2	4
Peat integrity	1	3	4
Microbiology	1	2	3
Other	1	2	3

**14a. Please specify the restoration target for each parameter**

<b>Answer Options</b>	<b>Response Frequency</b>	<b>Response Count</b>
Hydrology - function	81.8%	9
Plant species indicators	72.7%	8
Hydrology - quality	63.6%	7
Plant community structure	63.6%	7
Breeding birds	63.6%	7
Vegetation cover	54.5%	6
Invertebrates	36.4%	4
Carbon storage	36.4%	4
Greenhouse gas emissions	27.3%	3
Biodiversity	27.3%	3
Photography	27.3%	3
Physicochemistry	18.2%	2
Microbiology	9.1%	1
Peat integrity	9.1%	1
Remote sensing	9.1%	1
Other	9.1%	1

## 14b details

	<b>Hydrology - function</b>
2	Summer water table typically within 30-40 cm peat surface in deeper peat system
3	Water table less than 30 cm from peat surface in breeding season
4	Comparable with pristine site
7	Constant water table approx 10 cm below surface
8	Functions as a 'pristine' blanket bog
9	Water level within top 10 cm for 70% of year
12	Varies with parameter
21	Stable water tables, at surface in winter, 10 cm below in summer
26	Ground water level within 15 cm of surface all year
	<b>Plant species indicators</b>
2	Many within stands listed under the Habitats Directive for Target Fen Types (TFT) within the restoration project.
4	<i>Eriophorum</i> spp., Dwarf shrubs, Mosses (particularly <i>Sphagnum</i> , <i>Hypnum</i> )
7	Presence of <i>Sphagnum</i> spp.; absence of negative indicators
8	Peat forming species thriving
9	Continued presence and increase in extent of notified and biodiversity spp. defined in management plan
12	NVC indicator species increase
21	Increase in key indicator species within target NVC type
26	>20% <i>Sphagnum</i> , defined number of indicator species, max. Limit on scrub and negative indicator species
	<b>Hydrology - quality</b>
2	Almost untraceable nutrients within open water bodies; target of reduced nitrates in agricultural drains - aiming for TON peaks of less than 10 mg/l; typically under 5mg/l where possible. Ensure P levels remain very low - currently below 0.02 mg/l
4	Comparable with pristine site
8	Reduction in DOC export
9	Ombrotrophic conditions, pH less than 4 in all except marginal areas
12	Varies with parameter
21	Maintenance of current high quality
	<b>Plant community structure</b>
2	Determined predominantly via soil and hydrochemistry, then grazing/cutting management as secondary controlling processes.
4	M20 preferably M19 NVC
8	Characteristic of healthy blanket bog community & meeting PSA target
9	Less than 1% birch in site centre
12	NVC blanket bog community improvement
19	Increase from 30 - 50% in good condition by 2013
21	Restoration of appropriate NVC type (M17, etc)
	<b>Breeding birds</b>
2	Encourage a wide range of breeding wetland birds in addition to woodland species on unmanaged marginal areas. Coordinate management in sympathy with key species

	requirements.
3	Breeding bird surveys farm by farm every four years. No specific targets for numbers of breeding pairs etc yet made.
4	Numbers of upland breeding birds, particularly those for SPA designation
9	Increase in extent and breeding success of appropriate species
12	SPA and moorland assemblage species increase
19	Maintain sustainable populations of key birds
21	Increase in breeding waders (snipe, curlew). Maintenance of population of pipits and skylarks
	<b>Vegetation cover</b>
2	Flexible approach - help recovery of spatial area of <i>Cladium mariscus</i> stands; mosaic of fen meadows, sedge fen, tall-herb reed fen at end of grazing year (loose rule)
4	>80% cover
8	No bare peat
9	More than 20% <i>Sphagnum</i> and more than 70% of <i>Sphagnum</i> and <i>Eriophorum</i> spp.
12	Blanket bog indicators increase
26	Exposed substrate no more than 10%
	<b>Invertebrates</b>
2	Improve species records on site, and aim to undertake annual management in sympathy with invertebrate requirements where possible, particularly for notable species - Fen raft spider ( <i>Dolomedes plantarius</i> ) afforded specific management conditions (Ramsar species)
3	Some baseline aquatic invertebrates, no targets set
9	Continued presence and increases in extent of species defined in management plan
21	Increased diversity (not yet specified)
	<b>Carbon storage</b>
4	Stabilised peat loss
9	No loss
12	Directional- increase
	<b>Greenhouse gas emissions</b>
4	Comparable with pristine site for C flux
12	Directional- reduction
	<b>Biodiversity</b>
9	Continued presence and increases in extent of appropriate BAP species
12	SPA and SAC priority species/ habitats increase
	<b>Photography</b>
2	Annual fixed point photography at key panorama positions on the reserve annually, enabling comparisons from year to year.
4	>80% vegetation cover
9	5 year survey of fixed points and 10 year aerial repeat
	<b>Physicochemistry</b>
4	Monitoring pH and fertility indices to allow plant growth
	<b>Microbiology</b>



9	Just finding out what is there at the moment
	<b>Peat integrity</b>
9	No further loss of extent of peat, increase in re-pickled area to management plan limits
	<b>Remote sensing</b>
4	Decreasing area of bare peat
	<b>Other</b>
9	More adders, lizards and grass snakes

**15a. What is the approximate annual cost of monitoring?**

Answer Options	Response Average	Response Total	Response Count
£	18720	187200	10

Number	£
2	2000
3	4000
4	70000
7	200
8	30000
9	1000
12	35000
19	32000
21	3000
24	10000

**16a. Please provide an estimate of the annual cost for each monitoring parameter**

<b>Answer Options</b>	<b>Response Average</b>	<b>Response Total</b>	<b>Response Count</b>
Carbon storage	43000.00	43000	1
Hydrology - function	5583.33	33500	6
Hydrology - quality	5410.00	27050	5
Plant community structure	4341.67	26050	6
Breeding birds	4820.00	24100	5
Vegetation cover	3887.50	15550	4
Remote sensing	10000.00	10000	1
Biodiversity	2225.00	8900	4
Physicochemistry	2500.00	5000	2
Invertebrates	1550.00	3100	2
Plant species indicators	275.00	550	2
Photography	133.33	400	3
Microbiology	0.00	0	1
Peat integrity	0.00	0	1
Greenhouse gas emissions	0.00	0	0

**16b details**

<b>Project</b>	<b>2</b>	<b>3</b>	<b>4</b>	<b>7</b>	<b>8</b>	<b>9</b>	<b>12</b>	<b>19</b>	<b>21</b>	<b>24</b>
Carbon storage			43000							
Hydrology - function		2000	20000		5000	500	3000	3000		
Hydrology - quality	1000				20000	50	3000	3000		
Plant community structure	1000				4000	50	10000	6000		5000
Breeding birds		1000				100	6000	12000		5000
Vegetation cover			5000		500	50	10000			
Remote sensing			10000							
Biodiversity		800				100	3000	5000		
Physicochemistry			2000					3000		
Invertebrates						100			3000	
Plant species indicators					500	50				
Photography		200		200		0				
Microbiology						0				
Peat integrity						0				
Greenhouse gas emissions										

**17. Do you modify restoration as a result of the monitoring result?**

<b>Answer Options</b>	<b>Response Frequency</b>	<b>Response Count</b>
Yes	41.7%	5
No	58.3%	7

	<b>If yes, please specify</b>
<b>2</b>	Fine tuning of river level control via sluice structures has been enabled, with supporting evidence for hydrological function - from water level monitoring
<b>3</b>	Still too early in practical restoration to say if successful
<b>4</b>	Depends on the parameter and varies, monitoring often informs further steps to achieve targets
<b>9</b>	Go back and find out why areas are leaking
<b>13</b>	Live stock varied. Test Plots monitored before techniques used
<b>16</b>	N/A
<b>19</b>	Restoration target based on repeat Moorland condition Survey

**18. Can you list key reports/publications of your restoration monitoring?**

<b>Number</b>	<b>Response Text</b>
<b>2</b>	NVC Resurvey of Redgrave and Lopham Fen 2004 (plus interim survey reports on permanent quadrat monitoring). Breeding Bird Survey for Redgrave and Lopham Fen 2007
<b>3</b>	Water vole survey , Mortimer, 2006. Aquatic veg in ditches survey, Hammond, 2006 Aquatic inverts in ditches, Hammond 2006 (unpublished bird surveys conducted by volunteers) Breeding Bird Survey 2004 Winter bird survey 2005/6 Breeding Bird Survey 2008 ( archaeology investigations - by academic researchers) published various, but independent of wetland scheme - starcarr.com
<b>4</b>	Reports by Worrall & Evans (in review) Carbon Flux from managed peatlands, Allott et al (in review) Hydrological Benefits of Restoration, MFF report Vegetation Monitoring on Bleaklow and Blackhill, Caporn et al Effects of Lime and fertilizer on vegetation and microbial communities, MFF/RELU Landscape Audit, MFF Breeding Bird Survey of Peak District Moorlands, Manchester/Leeds Gully Blocking in Deep Peat, McMorrow et al (2005): Mapping and encoding the spatial pattern of peat erosion. Natural England (eds. Walker, J. & Buckler, M.) (in prep, due 2008) Upland Restoration Manual, web based resource and report.
<b>8</b>	The hydrological monitoring is being carried out by Fred Worrall at Durham University, so I don't actually hold any of the raw data. I assume he will want to publish reports once the monitoring is further along.
<b>10</b>	North York Moors National Park Authorities Moorland Research Review 2000-2005
<b>12</b>	Hydrological monitoring design report Vegetation monitoring reports- 3 Interim data analyses in preparation
<b>19</b>	No published reports Monitoring is part RSPB/part Peatscapes
<b>21</b>	Exmoor Mire Project reports, available on website or from Project Officer.
<b>22</b>	A couple of reports have been produced as part of this project but neither relate directly to restoration monitoring - Mosslands Vision report and full report; Salford City Council Mosslands Pilot HPZ scheme
<b>24</b>	Scm reports for NVC survey and breeding birds
<b>26</b>	Epworth Turbary SSSI Water Level Management Plan Preliminary Studies, March 2009. Isle of Axholme IDB.

**19. Are there any comments that you would like to make that might aid guidance on monitoring restoration success in peatlands?**

<b>Number</b>	<b>Response Text</b>
<b>3</b>	As plans evolve and initial restoration objectives change when project develops, it is difficult to anticipate what baseline data priorities will be later on. Measuring everything is simply not realistic and not easy to make case for cost and time expense of long term detailed monitoring. We don't always know what's important to measure till it has changed. Challenge in drawing comparisons between older data collected in the best available way at the time with newer data collected
<b>4</b>	The costs for the monitoring as listed include some of the other parameters. The benefits of fixed point photography can't be overstated- standards for this would be welcome. Aerial imagery is helpful for planning and we are investigating with J McMorrow and a CASSE student the benefits for monitoring restoration success. Working with universities has been helpful - this was aided by a small research grant scheme. For employing volunteers supervision is needed. Monitoring before restoration is difficult to achieve (time scales, resources) and spatial design with controls seem to work better. We are currently looking at cost-benefit flows from restoration with NE and the Defra Peat Ecosystem Service project.
<b>8</b>	Issues with timing of botanical surveys. We wanted summer surveys, to enable easier identification of species, but this was not acceptable for the two Estates in question, because of the proximity to the grouse shooting season, so the surveys were carried out in December and March.
<b>9</b>	We have to use volunteers extensively to collect and analyse data - site managers have not got time to do this. There should be more national co-ordination and funding
<b>10</b>	Make sure you have a substantial control area.
<b>12</b>	Need to communicate why robust monitoring is required, and standardised methods are required throughout the project and beyond. Without this staff are unlikely to be motivated/ interested. Metadata file describing data available should be produced and made accessible so data do not just sit unused.
<b>19</b>	Sharing of best practise and up to date information welcome as such a relatively new field of work
<b>26</b>	This project is still at the planning and design stage. Raised water levels have not yet been implemented. Projects like this are time consuming and can take several years before implementation. It is important that commitment to funding is followed through to implementation (and then to monitoring).

## **APPENDIX 2: NATURAL ENGLAND WORKSHOP**

The objective of the workshop was to explore ideas on the best approaches and tools for monitoring peatlands, to contribute to the development of a Peatland Monitoring Toolkit. The expected outcomes were the identification of key factors/techniques/approaches/tools that can indicate the progress and success of peatland restoration projects, and an assessment of empirical data required to monitor progress against targets.

The tasks were as followed:

1. The workshop was split into 2 groups: Group 1- upland peat, and Group 2- lowland peat
2. Each group first decided on the purpose of restoration.
3. The principal monitoring techniques were discussed along with sampling protocol (spatial/temporal) used to establish the progress/success of restoration. The following questions were considered:
  - a. What are the pros and cons for each technique?
  - b. What about pre- and post-restoration monitoring and the type of restoration technique(s)?
  - c. What do we know about the costs and benefits of your monitoring techniques?
  - d. What baseline and target data are currently used to evaluate the success of restoration?
4. Finally, the groups were asked what they have learnt that may help others?

### **A2.1. Uplands**

There were a number of reasons discussed for restoring upland peat which are listed in Box 1. However, there was no consensus as to which was the most important reason for restoring peat but an indication that restoration might have multiple objectives such as the habitat type, funding source, stakeholder views and especially socio-economic priorities. There was a suggestion that restoring for biodiversity would restore ecosystem integrity that could support the other restoration purposes such as the favourable condition objective of Natural England. Others suggested that not everything can be restored via biodiversity restoration e.g. greenhouse gas balance. Indeed, there is probably not enough scientific evidence yet to determine whether restoration for biodiversity does in fact reduce greenhouse gas emissions or increase water quality. The importance of restoration purpose was obvious from results presented for Wicken Fen that showed that standing water above the soil surface was required to increase the soil carbon (C) store, but that this environmental condition was adverse to the situation required by the Biodiversity Action Plan for the habitat.

**Box 1** Ecological and socio-economic reasons for restoring upland peatland

Biodiversity
Vegetation
composition/cover/structure
Carbon storage/sequestration
Reducing greenhouse gas emissions
Water table depth
Water quality/supply
Flood risk management
Cultural heritage
Paleoenvironmental evidence
Achieving conservation status

So, what are the favourable conditions of peat and how do you determine those conditions? Suggestions included characteristic plant species and a low level of impact from grazing/drainage. Agreement was reached that no loss of peat or chemical change in the peat was a major restoration task which may not be achievable in practice and that the objective of restoration needs clear definition prior to even pre-restoration monitoring. Also, consideration is required as to whether the site can even be restored to the desired target if there is one.

Techniques used for monitoring success of restoration were varied but the presence of *Sphagnum* and the species of *Sphagnum* were considered very important (e.g. *S. palustre*) as indicators of restoration success. Raising the water table was clearly a key method to achieve the objective of restoration success and this is closely tied to the development of *Sphagnum*. The diverse array of monitoring techniques included weather stations, dipwells, piezometers, runoff traps, erosion pins, photographic monitoring, vegetation cover/composition, gas collars for GHGs, invertebrates, fauna, testate amoeba (indicator of past hydrology), breeding bird surveys, microbiology and remote sensing. Sustainability of the restoration was considered very important. However, it was not clear how you can establish sustainability without long-term monitoring.

A number of projects included pre-restoration monitoring although this was dependent on planning and funding and may be associated with academic research as well as restoration projects. Baseline data (pre-restoration) was considered key to evaluation of restoration success. Some suggested that we need to know the condition of peat in order to achieve our objectives although it appears that very little pre-restoration monitoring occurs. In some cases restored sites have been compared to unrestored sites. Costs of monitoring can be low especially where volunteers have been used. However, hydrological monitoring and remote sensing can be expensive. It was felt that there is a difference between what you can do and what you want to do. Also, how frequently do you monitor? Storm events are not always captured by routine measurements.

Many experts felt that “we don’t know where we want to get to” in terms of restoration targets. Different sites are restored based on different objectives and criteria as listed in Box 1. This leads to the requirement for different monitoring techniques for measuring success as the success of the restoration depends on the type of restoration, and the ultimate purpose of the restoration. How do you define the target of restoration? Drift in both the baseline and target are likely due to climate or other environmental change. Are we really aiming for pristine conditions in peatlands or is that an unrealistic goal? Active management in stages is suggested where monitoring of restoration changes over time, dependent on the restoration targets of the peatland.



There does appear to be a requirement for guidance on monitoring the trajectory of peatland restoration particularly using cost effective techniques. However, it was argued that standardization of monitoring methods would stop moving innovative research forward. It appears that extensive monitoring occurs where it is funded by academic research, but monitoring is lacking where simple habitat restoration is the objective rather than gaining a clearer understanding of the restoration ecology of peatlands. Thus links between bodies such as universities and non-academic bodies involved in funding and managing restoration projects could be important. However, monitoring techniques are used in restoration projects and substantial monitoring data has been collected although there has been little if any evaluation of the available evidence base. Research is probably driven by the goals of C storage rather than restoration of the peatland to a functioning ecosystem (i.e. provider of multiple ecosystem services). It was even argued that we have not actually started restoration yet and are currently stabilising/maintaining peatlands by preventing degradation. Alternative policy drivers such as the need for rural regeneration and increase in socio-economic benefits will require alternative monitoring objectives to be included.

#### Summary of key points

1. Monitoring protocols depend on purpose/objectives of restoration.
2. We are still unsure about the nature and practical attainability of targets (and sometimes) baselines. This is complicated by a moving envelope of boundary conditions determining peat development and status.
3. Planning and funding are major concerns.

#### **A2.2. Lowlands**

The principle restoration methods for lowland peat were blocking drains, felling trees, raising ground water levels, landscape change, and reducing the cover of purple moor-grass. However, there was discussion as to whether restoration or creation was the objective, for example, Wicken Fen is an important restoration project but there is no bog there. Also, the question was stressed over whether restoration should aim for the most sustainable habitat rather than the most bio-diverse. The drivers for restoration were PSA, BAP and HLS targets and it was mentioned that one objective of restoration should be to aim to restore the functions attributed to biogeochemical processes in wetlands rather than short-term gains. As an example, it was suggested that banded grazing marsh would be better at Wicken Fen than fen or bog as that type of wetland would be more sustainable in the long-term.

Monitoring techniques appeared to overlap with those techniques applied to upland peat particularly hydrology and vegetation (*Sphagnum* indicators). Hydrological techniques included monitoring of water levels (dipwells, piezometers, automated pressure recorders, notch weirs/gauges/stage boards and determination of water flow in drains). In terms of water and peat quality, redox, pH, temperature and soil chemistry were deemed necessary though some of these parameters were poorly understood by some practitioners. Physical swelling groundwater effects and lunar cycle can alter water levels by 30 cm. The periodicity of the dipwell/piezometer readings is therefore very important and should be related to lunar cycle too.

*Sphagnum* cover was stressed as an important proxy for both water level and quality as well as peat surface conditions. Also, NVC characterization was deemed of importance such as signs of M17 being worth restoring but that M25 present could complicate restoration efforts. Research at Thorne & Hatfield moors (<http://www.thmcf.org/home.html>) has shown that the vegetation changes with the

wetting up. Initially indicator species were used and then a little more detail to NVC communities, also CSM.

Invertebrates and fungi were also considered possible indicators of restoration but might also be objectives. However, invertebrate monitoring was considered costly in which case invertebrates would best be monitored where they are deemed a special feature of a site in which case it would be an objective which could be directly monitored. Indicator species could be used to relate data sets to track changes in your variable of interest e.g. on the R. Tees there are fish spawning data which has been found to tie in with other environmental data and the fish records go back much further than the other set so assumptions can be made. Also, seasonality of fungi fruiting bodies has been related to environmental data.

Peat loss/accretion/erosion was considered an important monitoring variable. Lidar penetrating radar can be used to determine the density of peat and the EA fly regularly in lowlands but at different times of the year. Also, the height from a bridge or ground anchors can be used. However, caution was stressed as GPS and Ordnance can conflict and be 5-10cm out – height of raised mires can vary up to foot in a year depending on water input.

Only two sites monitored greenhouse gas exchange and only methane appears to have been measured.

Fixed point photography was deemed important but often not well used. It was suggested that it can be used horizontally or vertically. Good to record every quarter to see seasonal changes and to use aerial photos where possible.

Any monitoring protocol will depend on money and time available to record the site as well as the response time of the vegetation/hydrology to the changed circumstances. The 'what' and 'why' you are monitoring will determine the periodicity of monitoring. Common Standards Monitoring (CSM) could potentially be used for measuring success.

For long term monitoring, it is crucial to use the same methods throughout and these must be written into site management plan. Dipwells must tie into the datum and climate data. Good baseline data crucial but generally felt to be a paucity of such information. In terms of recording of monitoring data, long term funding stream required with cost effective monitoring techniques and survey protocols i.e. frequency.

## APPENDIX 3: DATABASE STRUCTURE

### A3. Introduction

One of the aims of this project was to organise and store peatland monitoring data in an electronic format suitable for analysis and forming the basis of a database for future monitoring information. With this aim in mind, one of the final deliverables for the project was for all existing peatland monitoring information available, to be collated in an electronic format and organised logically in such a way as to facilitate the development of a future peatland monitoring database.

Following the responses to the project questionnaire and feedback from stakeholders, however, it was clear that achieving this objective in its entirety would not be possible within the scope of this project. Many of the organisations involved in the restoration of peatlands were reluctant to provide data as it was collected for research purposes, data were in inaccessible formats or ownership of the data was such that the time required to put in place data sharing agreements would not allow its incorporation within the timescales of the project.

Of those that responded to the project questionnaire, 10 indicated that they would be willing to share monitoring data if available and each of these were contacted and requests made for monitoring data. Three of these restoration projects were able provide data<sup>3</sup> and these datasets were used to inform the database structure set out below. When the database template was completed, samples of these datasets were entered into the database to test its flexibility.

Constructing a database to collate data from disparate sources requires a compromise between a very open structure that allows all available data to be entered in any format, thus encouraging a large amount of data to be entered but making analysis difficult, and a rigid structure that requires extensive reformatting of data, makes data entry difficult and discourages stakeholders from entering data. At one end of this spectrum the database has a large amount of data but little capacity to be analysed at and at the other end of the spectrum analysis of data is straightforward but there is little data.

The database structure developed here, as set out in the specification, is intended to be a template for the development of a future peatland monitoring database, in terms of its structure, and could also act as a template for formatting data for entry into such a database. It has, therefore, been developed on the basis of the information on monitoring best-practice collated within the Technical Report, which helps to inform an 'ideal' structure, and information from peatland restoration projects that were able to provide real data, which help to make the data structure more pragmatic. Where data were not available on particular aspects of monitoring, the data structure is based solely on the guidance distilled from the literature review. In its final form, therefore, the structure of the database attempts to balance the requirements for data analysis with the need to facilitate data entry and compatibility with on-going projects.

Given the variety of data types and formats that will be entered into the database, a free-format with associated description of the data structure is the most effective means at the moment to enter data into the database. The variety of data types, sources and structures will make the use of forms for data entry extremely difficult. For instance, data may be time series for a single sampling point, at

---

<sup>3</sup> The authors would like to thank Dartmoor National Park Authority, Exmoor National Park Authority, North York Moors National Park Authority, Suffolk Wildlife Trust and Fermanagh District Council for providing data.

different frequencies of measurement, single measurements for multiple locations, multiple observations for a single location etc. This necessitates a free-format approach to data entry, although this will require closer quality control of data submissions it will be possible to automate some of these quality controls within the final database.

The following section describes the fields set out in the database template. The database structure has been implemented as an accompanying Excel spreadsheet. The example data included in the accompanying spreadsheet are extracts from data provided by various restoration projects. The purpose of including the data is to test the flexibility of the database structure to accept data from actual examples and to illustrate the format of the data. Within the database each measurement or data point is represented by on row of data.

### **A3.1. Explanation of fields**

#### **A3.1.1. Hydrology**

*ID*: Project ID. Linked to project metadata database. In an effort to build on existing work and not duplicate earlier efforts, The Moors For the Future Peat Compendium project<sup>4</sup> metadata format is proposed for storing information on peat restoration projects. This field serves as a common key field to link the two databases.

*Restoration treatment*: Type of restoration treatment applied. This list is constrained to be Stabilisation, Peat reprofiling, Reseeding, Planting, Grip-blocking, Gully-blocking, Vegetation removal, Stock reduction/exclosure, Rewetting, Draining, Vegetation burning, Fire suppression, None (for control plots) or Other.

*Note*: This is a free text field. If the restoration treatment entered is 'other' then a short description should be provided.

*Water Level*:

Location: location of measurement in GB or Irish grid reference

Pre/post treatment or control: is the measurement pre or post treatment, or is it a control site?

Identifier for site: Free text field for unique identifier for each sampling location. Can use project's own coding system or incremental number etc.

Date and time: date of measurement in format DD/MM/YYYY HH:MM

---

<sup>4</sup> Walker, J, Holden, J., Evans, M., Worrall, F., Davison, S., and Bonn, A. (2008) A compendium of UK peat restoration and management projects. Report to Defra, project code SP0556. [http://randd.defra.gov.uk/Document.aspx?Document=SP0556\\_7584\\_FRP.pdf](http://randd.defra.gov.uk/Document.aspx?Document=SP0556_7584_FRP.pdf)

Method: text field for brief details of method. Field is restricted to certain values that appear in a drop-down list, for example 'automatically logged - digital'. If 'Other' is entered then additional text explaining the method should be provided in the next column.

Water level (m): elevation of water surface above datum in meters.

Datum: datum used for measurements (Ordnance survey, local etc.)

Note: free text field for additional information.

#### *Hydraulic Head:*

Location: location of measurement in GB or Irish grid reference

Pre/post treatment or control: is the measurement pre or post treatment, or is it a control site?

Identifier for site: Free text field for unique identifier for each sampling location. Can use project's own coding system or incremental number etc.

Date and time: date of measurement in format DD/MM/YYYY HH:MM

Installed elevation: elevation of unscreened piezometer (m above datum).

Method: restricted text field for brief details of method. For example 'automatically logged - digital'. If 'Other' is entered then additional text explaining the method should be provided in the next column.

Hydraulic head (m): elevation of hydraulic head above datum

Datum: datum used for measurements (Ordnance survey, local etc.)

Note: free text field for additional information.

#### *Discharge:*

Location: location of measurement in GB or Irish grid reference

Pre/post treatment or control: is the measurement pre or post treatment, or is it a control site?

Date and time: date of measurement in format DD/MM/YYYY HH:MM

Method: restricted text field for brief details of method. For example 'flat plate weir'. If 'Other' is entered then additional details should be provided in the next column.

Discharge (m<sup>3</sup>/s): measured discharge in m<sup>3</sup>/s. If discharge has been measured with other units it should be converted to this standard.

Note: free text field for additional information.

*Precipitation:*

Location: location of measurement in GB or Irish grid reference

Date: date for measurement, depending on frequency (e.g. Jan, Feb, Mar for monthly rainfall, DD/MM/YYYY for daily)

Method: either on-site rain gauge, nearest weather station or other. If 'Other' is entered then additional information should be provided in the following column.

Total rainfall: total rainfall in mm for the specified period in the Date field.

Note: free text field for additional information.

*Evapotranspiration:*

Location: location of measurement in GB or Irish grid reference

Pre/post treatment or control: is the measurement pre or post treatment, or is it a control site?

Date: date for measurement, depending on frequency (e.g. Jan, Feb, Mar for monthly evapotranspiration total or monthly average, DD/MM/YYYY for daily)

Method: method used for measurement selected from drop-down list. If 'Other' is entered then additional information should be provided in the following column.

Evapotranspiration: measured evapotranspiration as total or rate

Units: units for measurement selected from list. If 'Other' is selected then units should be specified in next column.

Note: free text field for additional information.

A3.1.2. Biodiversity

*ID:* Project ID. Linked to project metadata database.

*Restoration treatment:* Type of restoration treatment applied. This list is constrained to be Stabilisation, Peat reprofiling, Reseeding, Planting, Grip-blocking, Gully-blocking, Vegetation removal, Stock reduction/exclosure, Rewetting, Draining, Vegetation burning, Fire suppression, None (for control plots) or Other.

*Note:* If restoration treatment is 'other' then a short description should be provided.

*Flora/cover:*

Location: location of measurement in GB or Irish grid reference

NVC code: National Vegetation Classification for site

Identifier (for plot, quadrat etc.): Free text field for unique identifier for each sampling location (e.g. for each quadrat on a transect). Can use project's own coding system or incremental number etc.

Pre/post treatment or control: is the measurement pre or post treatment, or is it a control site?

Survey method: text field for brief description of method e.g. random quadrat, fixed quadrat, transect, plot etc. If 'Other' is selected from predefined list then method should be specified in next column.

Quadrat size (m<sup>2</sup>): if method uses quadrats then the area of the quadrat in m<sup>2</sup> should be specified.

Survey date: date of measurement in format DD/MM/YYYY HH:MM

Species name/cover: name of species, can also be used to indicate presence of bare soil or rock.

Parameter: parameter that was measured (e.g. presence/absence, frequency, percentage cover) specified from a predefined list. If 'Other' is selected from predefined list then parameter should be specified in next column.

Value: data for measured parameter

Note: free text field for additional information.

*Fauna:*

Location: location of measurement in GB or Irish grid reference

NVC code: National Vegetation Classification for site

Identifier: Free text field for unique identifier for each sampling location (e.g. for each quadrat on a transect). Can use project's own coding system or incremental number etc.

Pre/post treatment or control: is the measurement pre or post treatment, or is it a control site?

Survey method: text field for brief description of method e.g. random quadrat, fixed quadrat, transect, plot etc. If 'Other' is selected from predefined list then method should be specified in next column.

Quadrat size (m<sup>2</sup>): if method uses quadrats (e.g. invertebrate survey) then the area of the quadrat in m<sup>2</sup> should be specified.

Survey date: date of measurement in format DD/MM/YYYY HH:MM

Taxon: Is the survey of birds, invertebrates, herpetiles, mammals or microbiota.

Species name: name of species

Parameter: parameter that was measured (e.g. presence/absence, frequency, percentage cover) specified from a predefined list. If 'Other' is selected from predefined list then parameter should be specified in next column.

Value: data for measured parameter

Units: units of measurement. If 'Other' is selected from predefined list then units should be specified in next column.

Note: free text field for additional information

### A3.1.3. Carbon

*ID*: Project ID. Linked to project metadata database.

*Restoration treatment*: Type of restoration treatment applied. This list is constrained to be Stabilisation, Peat reprofiling, Reseeding, Planting, Grip-blocking, Gully-blocking, Vegetation removal, Stock reduction/exclosure, Rewetting, Draining, Vegetation burning, Fire suppression, None (for control plots) or Other.

*Note*: If restoration treatment is 'other' then a short description should be provided.

#### *Carbon*:

Location: location of measurement in GB or Irish grid reference

Identifier: Free text field for unique identifier for each sampling location (e.g. for each quadrat on a transect). Can use project's own coding system or incremental number etc.

Pre/post treatment or control: is the measurement pre or post treatment, or is it a control site?



Survey method: text field for brief description of method e.g. random quadrat, fixed quadrat, transect, plot etc. If 'Other' is selected from predefined list then method should be specified in next column.

Date: date of measurement in format DD/MM/YYYY HH:MM

Method: method used for measurement. If 'Other' is selected then method should be entered into the next column. Further details can be entered in the Note field if necessary e.g. laboratory methods used.

Parameter: Parameter measured. Restricted to Soil Organic Carbon, Soil Organic Matter, Plant biomass, Carbon dioxide, Methane, Dissolved Organic Carbon, Dissolved Inorganic Carbon, Carbon as dissolved gases or Other. If 'Other' is selected then it should be entered into the next column.

Value: data for measured parameter

Units: units for measurement selected from a pre-defined list.

Note: free text field for additional information

#### A3.1.4. Water chemistry

*ID*: Project ID. Linked to project metadata database.

*Restoration treatment*: Type of restoration treatment applied. This list is constrained to be Stabilisation, Peat reprofiling, Reseeding, Planting, Grip-blocking, Gully-blocking, Vegetation removal, Stock reduction/exclosure, Rewetting, Draining, Vegetation burning, Fire suppression, None (for control plots) or Other.

#### *Water quality parameters*:

Location: location of measurement in GB or Irish grid reference

Identifier: Free text field for unique identifier for each sampling location (e.g. for each quadrat on a transect). Can use project's own coding system or incremental number etc.

Pre/post treatment or control: is the measurement pre or post treatment, or is it a control site?

Date: date and time of measurement in format DD/MM/YYYY HH:MM

Method: method selected from drop-down list

Parameter: name of parameter from drop-down list. Limited to Conductivity, pH, Ammonia, Nitrate, Phosphate, Phosphorous, Potassium, Magnesium, Chloride, Redox potential

and Other. If 'Other' is selected from list then parameter should be entered in next column.

Value: numerical value of sample

Units: units of measurement selected from drop-down list. If 'Other' is selected from list then parameter should be entered in next column.

Note: Free text field for additional information

#### **A4. Recommendations**

1. The database specification set out here can be used as the structure for a database of peatland monitoring data and as template for data entry to that database.
2. The structure proposed here should be further tested with stakeholders before it is finalised and adopted as no data were available from restoration projects to test some aspects of the structure e.g. carbon and greenhouse gas monitoring.
3. The specification is set out in an Excel format and will require implementation as a relational database by a specialist database developer to ensure that it is a sufficiently robust tool to allow wide distribution and access.
4. Should the database structure be implemented as a relational database it could be made available as an online resource for users to upload and download data. This would provide a valuable resource for stakeholders but would necessitate on-going maintenance and quality control of submitted data.

## APPENDIX 4: GREENHOUSE GAS FLUX COLLAR TECHNIQUES

### A4.1 Materials and procedures

#### *Materials*

1. Permanent collars made of PVC, stainless steel, or aluminium.
2. Soil knife to circumscribe collar location.
3. Enclosures with a vent, sampling port, and a mechanism for securing and sealing to permanent collars.
4. Polypropylene or nylon syringes (10 or 20 ml) fitted with three-way valves for transferring gases from chamber to evacuated gas vials; or gas tight glass syringes for transferring gases to the laboratory for analysis by gas chromatography.
5. Instrument for gas analysis. A gas chromatograph (GC) equipped with flame ionisation detector (FID) for CH<sub>4</sub> and CO<sub>2</sub> (with a methanizer), and an electron capture detector (ECD) for N<sub>2</sub>O.

#### *Procedure*

1. Insert the permanent collars into the peat to a depth of 5 to 10 cm at least 1 week prior to sampling to avoid disturbance.
2. Put the enclosure in place and record the time.
3. Establish the time-zero concentration of the gas by taking 3 or more air samples (10 or 20 ml).
4. Sample 10 or 20 ml of the enclosure volume every 10 minutes for at least 1 hour. Pump the syringe 3 times to mix the gas in the enclosure headspace, extract a volume of gas and close the syringe using the three-way valve. The gas can then be placed in a pre-evacuated vial for transport to the laboratory. Record the time of each sampling. If the rate of exchange is very low, it may be necessary to sample less frequently over a longer period. The size of the sample taken always exceeds the minimum needed for analysis.
5. In the laboratory, analyse the samples for the gases of interest by gas chromatography. Alternatively, CO<sub>2</sub> concentrations in the enclosure could be monitored using an infra-red gas analyser (IRGA).

## A4.2 Calculations

Calculations of rates of trace gas exchange are based on a difference in the concentration of the gas over time (Holland et al. (1998). The calculations required for estimating either net production or net consumption of a gas are conceptually straightforward but can be complicated by the fact that the concentration gradient between the peat and the atmosphere begins to diminish immediately upon deployment of the enclosure (Hutchinson and Livingston, 1993). Further complication are introduced by the disruption of the atmospheric boundary layer; the importance of these disruptions to the estimated flux increases with the length of time a chamber is in place (Healy et al. 1996). Thus a short deployment time is recommended for the enclosures. For a further review of trace gas fluxes see Livingston and Hutchinson (1995).

All measured gas concentrations are converted to mass units and corrected to field conditions through application of the Ideal Gas Law (Holland et al, 1998):

$$C_m = (C_v \times M \times P) / (R \times T) \quad \text{Eq.2}$$

Where

$C_m$  = the mass/volume concentration e.g.  $\mu\text{g CO}_2 \text{ L}^{-1}$  enclosure, equivalent to  $\text{mg CO}_2 \text{ m}^3$

$C_v$  = the volume/volume concentration e.g.  $\mu\text{L CO}_2 \text{ L}^{-1}$  enclosure or ppm  $\text{CO}_2$

$M$  = the molecular weight of the gas species of interest e.g.  $44 \mu\text{g CO}_2 / \mu\text{mol CO}_2$  (12 for  $\text{CO}_2\text{-C}$ ),  $16 \mu\text{g CH}_4$  (12 for  $\text{CH}_4\text{-C}$ ), and  $44$  for  $\text{N}_2\text{O}$  ( $28$  for  $\text{N}_2\text{O-N}$ )

$P$  = barometric pressure e.g. 1 atm

$T$  = air temperature within the enclosure at the time of sampling in  $^\circ\text{K} = ^\circ\text{C} + 273.15$

$R$  = the universal gas constant ( $0.0820575 \text{ L atm } ^\circ\text{K mole}$ ).

The converted concentration values are then used to calculate the flux of interest. The most commonly used equation assumes a constant flux ( $f$ ) and a linear increase in trace gas concentration ( $C$ ) over time ( $t$ ):

$$f = V \times C_{rate} / A$$

where

$f$  = gas flux as  $\text{mg CO}_2 \text{ m}^{-2} \text{ h}^{-1}$

$V$  = the internal volume of the enclosure, including collar volume, expressed as  $\text{m}^3$

$A$  = the soil area the enclosure covers, expressed as  $\text{m}^2$

$C_{rate}$  = change in concentration of gas ( $C_m$ ) over the enclosure period, expressed as  $\text{mg CO}_2 \text{ m}^{-3} \text{ h}^{-1}$

The calculation of gas concentration change should include only data for the time period of linearly increasing trace gas concentrations in the chamber. Thus,  $C_{rate}$  is the slope of the best-fit line for the regression of gas concentration (mass/m<sup>3</sup>) versus time (h). Each flux series should be graphed and evaluated for linearity; individual point measurements should be carefully checked and discarded if outside confidence bounds. The recommended units for expression of the flux are  $\mu\text{g N}_2\text{O m}^{-2} \text{h}^{-1}$ ,  $\text{mg CH}_4 \text{m}^{-2} \text{h}^{-1}$ , and  $\text{mg CO}_2 \text{m}^{-2} \text{h}^{-1}$ .